



# Taking the Long View

.....  
Michaela French

Cultivating an ecological worldview through  
the attentive observation of light

Michaela French

A thesis submitted in partial fulfillment of the requirements of the Royal College of Art  
for the degree of Doctor of Philosophy.

January 2020

# i. Abstract

## Copyright Statement

This text represents the submission for the degree of Doctor of Philosophy at the Royal College of Art. This copy has been supplied for the purpose of research for private study, on the understanding that it is copyright material, and that no quotation from the thesis may be published without proper acknowledgement.



Figure 1.1: *A Year of Light* 13/365 (2015),  
Michaela French.

Light as an ecological phenomenon is the catalyst for this practice-based artistic research which investigates the systemically entwined interrelation between light and perceiver. James J. Gibson's *The Ecological Approach to Visual Perception* provides the methodological foundation for this investigation by situating a perceiver in a direct, reciprocal and inseparable interrelation with the field of light he calls the ambient optic array. Light as information is central to this enquiry which develops a framework for practice-based ecological artistic research in response to the following questions:

1. Which principles and concepts from Gibson's ecological approach to visual perception might be adapted and applied to frame ecological artistic research that facilitates an education of attention through the rigorous observation of light?
2. What practice-based methods emerging from a Gibsonian research framework might be applied through artistic practice to cultivate an ecological worldview?

Gibson's ecological paradigm has a long association with art and design practice. However, his approach has not yet been adapted as a framework for practice-based artistic observation of light. The Gibsonian methodology I develop combines artistic practice with ecological theory, visual perception, subjective observation and the science of light. The framework is applied through four practice-based artistic research projects that investigate core tenets of Gibson's theory through the observation of light, using three research methods: Durational Observation, Ecological Lens and Reflective Artistic Practice. My study is positioned within the emerging interdisciplinary field of ecological artistic scholarship.

As an artist-researcher, my subjective interactions with light served as a site for enquiry and reflection, as my perceptual experience, intention and attentive awareness influenced the quality and breadth of the knowledge emerging from this investigation. By applying Gibson's concept of an education of attention, which considers the perceptual system capable of maturation and learning as it is sensitised to increasingly refined information, new understanding was found to emerge from changing how I perceive, rather than changing what I know.

My practice-based enquiry demonstrates the value of Gibson's theory as a framework for ecological artistic research. The findings show that the Gibsonian research framework can effectively facilitate an education of attention — the rigorous observation of light leads to attunement; attunement to light leads to an education of attention; an education of attention undertaken through the rigorous observation of light using the Gibsonian research framework cultivates an ecological worldview. This constitutes my original contribution to knowledge, which is supported by a body of evidence consisting of a comprehensive review of relevant theory and practice, visual data sets and light-based artworks.

In establishing a research framework capable of cultivating an ecological worldview, my research may afford a broader contribution in addressing the ecological imperatives that increasingly influence contemporary artistic and cultural discourse.

## ii. Contents

<b>i. Abstract</b>	<b>5</b>
<b>ii. Contents</b>	<b>9</b>
<b>iii. Illustrations and Tables</b>	<b>13</b>
List of Illustrations	15
List of Tables	19
<b>iv. Acknowledgements</b>	<b>20</b>
<b>v. Author's Declaration</b>	<b>21</b>
<b>vi. Definition of Terms</b>	<b>22</b>
<b>Chapter One: Introduction</b>	<b>27</b>
1.1 A Practice of Light	29
1.2 Research Questions	29
1.3 Defining an Ecological Terrain	30
1.4 Gibson's Theory as a Methodological Approach	37
1.5 Contribution to Knowledge	39
1.6 Navigating the Thesis	39
<b>Chapter Two: An Ecological Context</b>	<b>41</b>
2.1 Introduction	43
2.2 Light as Information	43
2.3 An Ecological Lineage	44
2.4 Tracing a Gibsonian Ecological Path	52
2.5 Information Experience Design	82
2.6 Identifying a Gap in Knowledge	84
2.7 A Contextual Summary	86
<b>Chapter Three: An Ecological Methodology</b>	<b>89</b>
3.1 Introduction	91
3.2 A Gibsonian Framework for Ecological Artistic Research	91
3.3 Six Defining Methodological Principles	93
3.4 An Action Model for Ecological Artistic Research	95
3.5 Research Methods	97
3.6 Defining the Evaluation Criteria	99
3.7 Summary	101
<b>Chapter Four: Project One - A Year of Light</b>	<b>103</b>
4.1 An Overview of the Practice-based Research	105
4.2 A Year of Light - Introduction	105
4.3 Description of the Artistic Research Process	106
4.4 A Year of Light - Findings	113

4.5 Discussion: An Emerging Ecology of Light	114
4.6 A Year of Light - Summary	121
<b>Chapter Five: Project Two - The Old Lookout</b>	<b>123</b>
5.1 The Old Lookout - Introduction	125
5.2 Description of the Artistic Research Process	125
5.3 The Old Lookout - Findings	134
5.4 Discussion: A New Level of Description	135
5.5 The Old Lookout - Summary	142
<b>Chapter Six: Project Three - Daylight Observations</b>	<b>143</b>
6.1 Daylight Observations - Introduction	145
6.2 Description of the Artistic Research Process	146
6.3 Daylight Observations - Findings	154
6.4 Discussion: A New Level of Description	156
6.5 Daylight Observations - Summary	162
<b>Chapter Seven: Project Four - Earth Below Me Sky Above</b>	<b>165</b>
7.1 Earth Below Me Sky Above - Introduction	167
7.2 Description of the Artistic Research Process	167
7.3 Earth Below Me Sky Above - Findings	173
7.4 Discussion: A New Level of Description	174
7.5 Earth Below Me Sky Above - Summary	179
<b>Chapter Eight: Taking the Long View</b>	<b>181</b>
8.1 Introduction	183
8.2 Findings	183
8.3 Research Findings and Conclusions	187
8.4 Original Contribution to Knowledge	188
8.5 Research Limitations and Future Directions	190
8.6 Closing Summary	192
<b>Bibliography</b>	<b>195</b>
<b>Appendix</b>	<b>209</b>

## iii. Illustrations and Tables

## List of Illustrations

### Chapter One

Figure 1.1: *A Year of Light* 13/365 (2015), Michaela French.

### Chapter Two

Figure 2.1: *Action Research as a Spiral of Planning, Implementing and Evaluating* (1946), Kurt Lewin, redrawn by Stephen Kemmis (Sydney: Stephen Kemmis, 1990). <<https://eric.ed.gov/?id=ED200560>> [accessed 2 November 2019].

Figure 2.2: *Cyanometer* (1760), Horace-Bénédict de Saussure. Courtesy of the Bibliothèque de Genève, Arch. Saussure 66/7.

Figure 2.3: 'Sign, Image, Symbol', *Vision + Value Series* (1966), György Kepes (New York, NY: Braziller Publishing, 1966).

Figure 2.4: *Carn White* (1967), James Turrell, Photo: Florian Holtzherr, <<http://jamesturrell.com/work/carn-white/>> [accessed 19 April 2019] [This image has been redacted from the thesis for reasons of copyright].

Figure 2.5: *Breathing Light* (2013), James Turrell, Photo: Florian Holtzherr, <<http://jamesturrell.com/work/breathing-light/>> [accessed 19 April 2019] [This image has been redacted from the thesis for reasons of copyright].

Figure 2.6: *Within Without* (2010), James Turrell, Photo: Michaela French. [This image has been redacted from the thesis for reasons of copyright]

Figure 2.7: *Ground # 38* (1994), Uta Barth, Ektacolor print on panel (20 x 20 inches), Edition of 8; 2 APs. Courtesy the artist and Tanya Bonakdar Gallery, New York / Los Angeles.

Figure 2.8: *Ground # 46* (1994), Uta Barth, Face-mounted pigment print on panel (19 1/2 x 21 inches), Edition of 8, 2 APs. Courtesy of the artist and Tanya Bonakdar Gallery, New York / Los Angeles.

Figure 2.9: *Ground # 44* (1994), Uta Barth, Ektacolor print on panel (39 1/4 x 48 inches), Edition of 3; 2 APs. Courtesy of the artist and Tanya Bonakdar Gallery, New York / Los Angeles.

Figure 2.10: *Model for a timeless garden* (2011), Olafur Eliasson, Water, pumps, nozzles, stainless steel, wood, foam, plastic, strobe lights, wall mounts, control unit (160 x 970 x 100 cm), Installation view: Hayward Gallery, London, 2013, Photo: Marcus J Leith. Courtesy of Olafur Eliasson © 2011.



Figure 2.11: *Model for a timeless garden* (2011), Olafur Eliasson, Water, pumps, nozzles, stainless steel, wood, foam, plastic, strobe lights, wall mounts, control unit (160 x 970 x 100 cm), Installation view: Studio Olafur Eliasson. Courtesy of Olafur Eliasson © 2011.

Figure 2.12: *Model for a timeless garden* (2011), Olafur Eliasson, Water, pumps, nozzles, stainless steel, wood, foam, plastic, strobe lights, wall mounts, control unit (160 x 970 x 100 cm), Installation view: Pinchuk Art Centre, Kiev, 2011, Photo: Dimitry Baranov. Courtesy of Olafur Eliasson © 2011.

Figure 2.13: *9 Framed Titles 1978* (1978-1980), Roger Ackling. Photo: Michaela French. Courtesy of Annelly Juda Gallery, © The Estate of the Artist.

Figure 2.14: *Weybourne* (1992), Roger Ackling. Photo: Michaela French. Courtesy of Annelly Juda Gallery, © The Estate of the Artist.

Figure 2.15: *Voewood* (detail) (2011), Roger Ackling. Photo: Michaela French. Courtesy of Annelly Juda Gallery, © The Estate of the Artist.

Figure 2.16: *Spiral Jetty* (1970), Robert Smithson. Photo: Gianfranco Gorgoni. From the permanent collection at the Utah Museum of Fine Arts, University of Utah, Salt Lake City. Purchased with funds from The Phyllis Cannon Wattis Endowment Fund. Images provided by the Utah Museum of Fine Arts. Image courtesy of the Utah Museum of Fine Arts.

Figure 2.17: *Great Salt Lake and Vicinity* (2017) Spencer Finch, paper, pencil, Pantone color system, site specific installation. From the permanent collection at the Utah Museum of Fine Arts, University of Utah, Salt Lake City. Purchased with funds from The Phyllis Cannon Wattis Endowment Fund. Image provided by the Utah Museum of Fine Arts.

Figure 2.18: *Great Salt Lake and Vicinity* (2017) Spencer Finch, paper, pencil, Pantone color system, site specific installation. From the permanent collection at the Utah Museum of Fine Arts, University of Utah, Salt Lake City. Purchased with funds from The Phyllis Cannon Wattis Endowment Fund. Image courtesy of the Utah Museum of Fine Arts.

Figure 2.19: *Great Salt Lake and Vicinity* (2017) Spencer Finch, (detail of the *Spiral Jetty*), paper, pencil, Pantone color system, site specific installation. From the permanent collection at the Utah Museum of Fine Arts, University of Utah, Salt Lake City. Purchased with funds from The Phyllis Cannon Wattis Endowment Fund. Image courtesy of the Utah Museum of Fine Arts.

## Chapter Four

Figure 4.1: *A Year of Light: 15/365, 29/365, 89/365, 171/365, 226/365, 259/365, 268/365, 315/365* (2015), Layers of Reflection, Michaela French.

Figure 4.2: *A Year of Light: 310/365, 319/365* (2015), Twitter Feed Examples, Michaela French.

Figure 4.3: *A Year of Light: 25/365, 74/365, 88/365, 109/365, 110/365, 172/365, 176/365, 211/365, 237/365, 251/365, 264/365, 327/365* (2015), Light and Shadow, Michaela French.

Figure 4.4: *A Year of Light: 12/365, 21/365, 56/365, 82/365, 123/365, 180/365, 182/365, 192/365, 218/365, 271/365, 295/365, 335/365* (2015), Radiant Light, Michaela French.

Figure 4.5: *A Year of Light: 120/365, 149/365, 173/365, 258/365, 332/365* (2015), Me and my Shadow, Michaela French.

Figure 4.6: *A Year of Light - 365 Observations* (2015), Michaela French, (London: 'The Observer Effect', Hockney Gallery, Royal College of Art, 2016).

Figure 4.7: *A Year of Light - 365 Observations* (2015), Michaela French, ('The Observer Effect', Hockney Gallery, Royal College of Art, London 2016).

Figure 4.8: *A Year of Light - 365 Observations* (2015), Michaela French, 'Catching the Light', Sidney Cooper Gallery, Canterbury, UK.

Figure 4.9: *A Year of Light - Artist's Book* (2017), Michaela French.

Figure 4.10: *A Year of Light - Artist's Book* (2017), Michaela French.

## Chapter Five

Figure 5.1: The Old Lookout Studio: exterior/interior, Broadstairs Harbour, UK (2015), Michaela French.

Figure 5.2: Three Data Collection Techniques: recording light samples time-lapse photography, digital light sensor, and subjective observations by eye, with initial paint swatch tests (2015), Michaela French, The Old Lookout Studio, Broadstairs UK.

Figure 5.3: Work-in-Progress: The first Subjective Colour Swatch data-collection observation (2015) Michaela French, The Old Lookout Studio, Broadstairs UK.

Figure 5.4: The completed Subjective Colour Swatch spreadsheet (2015), Michaela French, The Old Lookout Studio, Broadstairs UK.

Figure 5.5: Detail of the completed Subjective Colour Swatch spreadsheet (2015), Michaela French, The Old Lookout Studio, Broadstairs UK.

Figure 5.6: *Frame* (2015), Michaela French 'The Motion of Matter', Bow Arts Project Space, London.

Figure 5.7: *Specimen Drawer Sky and Sea* (2015) Michaela French, 'The Motion of Matter', Bow Arts Project Space, London.

Figure 5.8: *Daylight Observations: The Old Lookout* (2015) Michaela French, 'The Motion of Matter', Bow Arts Project Space, London.

Figure 5.9: *Daylight Observations: The Old Lookout: 24 hour* (2015), Michaela French, 'The Observer Effect' Hockney Gallery, Royal College of Art, London.

## Chapter Six

Figure 6.1: Subjective Colour Swatch spreadsheet (detail), *Daylight Observations* study, 21st December 2015, Michaela French.

Figure 6.2: Sunrise, *Daylight Observations* study, 21st December 2015, Michaela French.

Figure 6.3: *Et sic in infinitum* (And so on to Infinity) (1617-1618), Robert Fludd, (*Utriusque cosmi maioris...*, Page 26) Credit: Wellcome Collection <<https://wellcomecollection.org/works/swb6pv6u>> [accessed 30 August 2015].

Figure 6.4: *Hubble Ultra Deep Field* (2014), NASA and ESA, (Baltimore: NASA Hubble Space Telescope, 2014) <<https://hubblesite.org/image/3380/gallery/58-hubble-ultra-deep-field>> [accessed 22 March 2017]

Figure 6.5: *Orbit No.12 - 21st November 2016, Latitude: 51° 45' 41" N, Longitude: 0° 00' 41" W, Location: Hoddesdon, Hertfordshire, UK, Direction of View: 96 E* (2016), Michaela French.

Figure 6.6: *The Orbit Series* (2017), Michaela French.

Figure 6.7: *Transmission Device No. 2 and 3: Shortest Day Rhythm, Winter Equinox, 21st December 2015 and Longest Day Rhythm, Summer Equinox, 21st June 2016* (2016), Michaela French. 'Catching the Light', Sidney Cooper Gallery, Canterbury, UK.

Figure 6.8: *The Orbit Series: 1 - 7* (2016), Michaela French, 'Catching the Light', Sidney Cooper Gallery, Canterbury, UK.

Figure 6.9: *Daylight Observations: 21st December 2015, Latitude: 51° 45' 41" N, Longitude: 0° 00' 41" W, Location: Hoddesdon, Hertfordshire, UK, Direction of View: 111 E* (2016); *Daylight Observations: - 21st June 2016, Latitude: : 39° 58' 14.9597" N, Longitude: 83° 0' 10.4782" W, Location: Columbus Ohio, USA, Direction of View: 81 E* (2016), Michaela French.

Figure 6.10: *Orbit No.2 - 21st January 2016, Latitude: 51° 45' 41" N, Longitude: 0° 00' 41" W, Location: Hoddesdon, Hertfordshire, UK, Direction of View: 124E* (2016), Michaela French.

Figure 6.11: *The Orbit Series* (2016), Michaela French, 'Balance-Unbalance', Ocean Studios, Plymouth, UK.

## Chapter Seven

Figure 7.1: Ground and Sky, *Earth Below Me Sky Above* (2017), Michaela French Selected documentation.

Figure 7.2: *Your glacial expectations* (2012), Olafur Eliasson and Günther Vogt. Mirrors, trees, chairs, sheep. Installation view: Kvadrat, Ebeltoft, Denmark. Photo: Annabel Elston. Courtesy of Olafur Eliasson © 2012.

Figure 7.3: Here and Out There, *Earth Below Me Sky Above* (2017), Selected Documentation, Michaela French.

## List of Tables

### Chapter One

Table 1.1: The Distinction Between the Experiential and Physical Characteristics of Light (1985) Richard A. Kasschau, *Psychology: Exploring Behavior* (New Jersey: Prentice-Hall, 1980). Redrawn by Michaela French.

### Chapter Three

Table 3.1: The Gibsonian Framework for Ecological Artistic Research (2019), Michaela French.

Table 3.2: Adapting Gibsonian Principles to a Framework for Ecological Artistic Research (2019), Michaela French.

Table 3.3: The Ecological Lenses applied in each Artistic Research Project (2019), Michaela French.

Table 3.4: Specification of the Evaluation Criteria (2019), Michaela French.

### Chapter Six

Table 6.1: The Five Stages of the Gibsonian Framework for Ecological Artistic Research (2019), Michaela French.

### Chapter Eight

Table 8.1: Evaluation Criteria and Research Outcomes (2019), Michaela French.

## iv. Acknowledgements

*Taking the Long View* has been a long journey: an unfolding and a profoundly personal education of attention which has required me to move beyond many perceived boundaries and to question and relinquish established ways of thinking and being. In *Taking the Long View* I have learned to see in a new way, for this I am very grateful.

This study would not exist without the visionary ecological approach of psychologist James J. Gibson. His ecological paradigm has afforded a way of thinking that has allowed me to bring new understanding to my systemically entwined interrelation with light. Deep appreciation to Gibson for having the vision and courage to offer a new level of description.

Sincere gratitude to my core supervisory team, Dr Kevin Walker and Joe King, who have inspired, challenged and supported this research project over six long years. My many conversations with you two have been a pleasure and a joy. Thank you. Many thanks also to Professor Teal Triggs for your ongoing belief in my potential as a researcher and for stepping in for the final round. Heartfelt thanks to Dr Helga Schmid, Clare French and Cathy Johns for your commitment, attention to detail, care and fine-tuning. Your support has been pivotal to my process.

Warm and sincere thanks to my many friends and colleagues for your guidance, your insights, your generosity, your encouragement, your cheering, your time, your creativity, your challenges, your expectations, and your faith in my ability to bring this project to a satisfactory close. Thank you to Franziska, Kelly, Anna, Hazel, Mike, Max, Tessa, Olaf, Rachael, Pia, Catherine, Andy, Sibille, Susie, Yaron, Lisa, Lylo, Anastacia, Andy, Andrée, Donny, Kamil, Claudia, Maybelle, Guy and Kathy. Love and thanks to my sisters Abby, Louise and Clare for knowing the perfect moment to remind me I could climb the mountain. Thanks to the boys Martin, Arlo, Jesse and Dan, and to Frances for your enthusiasm, support and faith in me. Unbounded gratitude, love and admiration to Richard Godbold for your sturdy arms, your immense patience, your encouragement, your questioning and your steadfast love. You are wonderful.

Finally, I dedicate this PhD thesis to my beautiful parents Mary and Eric French who taught me to see the light and to wonder what it was I saw.

Thank you one and all. I have made it!

## v. Author's Declaration

During the period of registered study in which this thesis was prepared the author has not been registered for any other academic award or qualification. The material included in this thesis has not been submitted wholly or in part for any academic award or qualification other than that for which it is now submitted. I confirm that the work presented here is my own. Where information has been derived from other sources, I confirm that this has been indicated in the thesis.



Michaela French

January 2020

## vi. Definition of Terms

In this section, I define the key terms used in this thesis in the context of my ecological artistic research. Many of these definitions draw directly on James J. Gibson's ecological paradigm and are framed by the ecological principles that govern this study.

### Affordances

Following Gibson's definition, 'the *affordances* of the environment are what it offers the animal, what it provides or furnishes'.<sup>1</sup> Affordances are emergent relational possibilities which are 'equally a fact of the environment and a fact of behavior'.<sup>2</sup> An inseparable reciprocity between perceiver and environment<sup>3</sup> enables a perceiver to alter available affordances by expanding their perceptual capacity and changing their behaviour to create new interactions with an environment. In this research, affordances manifest as action possibilities, new concepts, or new ways of conceiving the world. (Section vi: Unconventional Affordances, p. 26).

### Attention

Attention can be understood as a process of noticing and seeking out specific information (Section vi: Information, p. 23). According to Gibson, perceiving itself is an act of attention, which is both selective and integrative.<sup>4</sup> Whilst attention is derived from sustained focus it 'can be distributed as well as being concentrated'. Gibson posits that 'awareness of details is not inconsistent with the awareness of wholes'.<sup>5</sup> 'A single act of attention'<sup>6</sup> may therefore incorporate multiple acts of awareness and various types of information. From Gibson's ecological perspective it is possible to increase perceptual capacity through the practice of attentive observation.

### Ecological

My use of the term ecological in this thesis derives from ecological psychology, and is defined as the systemic interrelationship between organisms, human and non-human, and their co-evolution with the environment.<sup>7</sup> The Gibsonian ecological principles that govern this study have their lineage in the long-established ecological traditions of Western philosophy and the biological sciences (Section 2.3, p. 44).

.....

<sup>1</sup> James J. Gibson, *The Ecological Approach to Visual Perception* (New York, NY: Taylor and Francis, 1979), p. 127.

<sup>2</sup> Ibid., p. 129.

<sup>3</sup> Ibid., p. 127.

<sup>4</sup> Ibid., p. 149.

<sup>5</sup> Ibid.

<sup>6</sup> Ibid.

<sup>7</sup> Kyle Kilbourne and Jessica Isaksson, 'Meaning through Doing: The Role of Affordances over Time', *Sixth Nordcode Seminar & Workshop: Design Semiotics in Use* (Helsinki, Finland: University of Art and Design, 2007), p.2.

### Ecological Perception

Following Gibson, ecological perception is understood as a direct perceptual interaction between a perceiver and their environment which is governed by inseparable and reciprocal mutuality.<sup>8</sup> Environmental properties are perceived as meaningful information through direct perception, which is neither aided nor influenced by higher cognitive processing.<sup>9</sup> Knowledge of an environment evolves as perception is refined, expanded and enriched through the attentive actions of a perceiver.

### Environment

In an ecological context an environment is distinct from the structures, surfaces and substances of the physical world.<sup>10</sup> Rather, an environment is what is perceived, and is therefore dependent on the perceptual capacity of a perceiver.<sup>11</sup> The scale, boundaries and affordances of an environment are partially determined by a perceiver's direct perceptual interaction with the physical world.<sup>12</sup>

### Experience

Experience is defined as the direct interaction of a perceiver in a process of perceptual engagement with their environment. In Gibson's ecological approach, 'the reality of experience is grounded in action'.<sup>13</sup> The act of perceiving and experiencing an environment inherently involves the co-perceiving of the self.<sup>14</sup> Experience is concomitant with being; it is the lived encounter with the world, and the only way we can know reality.<sup>15</sup> Unfolding through the perceptual process, experience is a reciprocally and systemically entwined interrelation between light, perceiver and environment (Section vi: Light-perceiver-environment nexus, p. 25).

### Information

Differentiation is the basis of information as it is defined in this thesis. Difference in an otherwise uniform field is considered an 'elementary unit of information'.<sup>16</sup> Information

.....

<sup>8</sup> Gibson, 1979, p. 8.

<sup>9</sup> 'Ecological Perception', in *American Psychology Association Dictionary of Psychology*, <<https://dictionary.apa.org/ecological-perception>>, [accessed 15 April 2016].

<sup>10</sup> Gibson, 1979, p.15.

<sup>11</sup> Ibid.

<sup>12</sup> Ibid., pp. 9-10.

<sup>13</sup> John M. Flach and John G. Holden, 'The Reality of Experience: Gibson's Way', *Presence*, 7.1 (1998), 90–95 (p.94).

<sup>14</sup> Gibson, 1979, p. 240.

<sup>15</sup> *Experience*, ed. by Caroline A. Jones, David Mather, and Rebecca Uchill (Cambridge, MA: MIT Press, 2016) p. 08.

<sup>16</sup> Gregory Bateson, *Steps to an Ecology of Mind: Collected Essays in Anthropology, Psychiatry, Evolution, and Epistemology* (Chicago, IL: University of Chicago Press, 1972). p. 459.

is a variation that 'shows up against a background of sameness',<sup>17</sup> or 'a difference which makes a difference'.<sup>18</sup> Information is a spatial phenomenon which differentiates between medium, surface, and substance. Information is 'a temporal phenomenon: it is what mediates between one event and a later one'.<sup>19</sup> Occurring over space and time as variations, or differences, information can specify an environment, an experience and/or change over time. Ecological information is available to a perceiver through 'the first hand perception of being-in-the-world':<sup>20</sup> as such, the perceptual capacity and exploratory actions of a perceiver influence the information available within an environment. In visual perception differences in intensity, colour or quality in ambient light equates to information.<sup>21</sup>

## Light

Light is understood in two ways in this research: drawing on the physical sciences, visible light is defined as electromagnetic radiation with a wavelength within the range to which the human retina responds (390 nm (violet light) to 740 nm (red)).<sup>22</sup> Light consists of photons that behave as both waves and particles and travel at 299,792 km per second when measured in a vacuum.<sup>23</sup> 'White light consists of a mix of all visible wavelengths, which can be separated to yield the colours of the spectrum'.<sup>24</sup> Light is 'the natural agent that stimulates sight and makes things visible'.<sup>25</sup> However, light itself can only be seen 'in conjunction with other things':<sup>26</sup> therefore the observation of 'light inevitably loops back as experience'<sup>27</sup> (Section vi: Experience, p. 23).

An experiential understanding of light underpins Gibson's ecological theory, which differentiates between radiant and ambient light. Radiant light causes illumination, and emanates from an energy source. Ambient light is the result of illumination which converges to a point of observation. Radiant light is propagated, ambient light is present; radiant light is energy, ambient light is information.<sup>28</sup> Gibson's notion of light as information deviates from mainstream thinking, and is the foundation on which Gibson's

17 Maurice Merleau-Ponty, in David A. Grandy, *The Speed of Light: Constancy and Cosmos* (Bloomington: Indiana University Press, 2009), p. 134.

18 Bateson, 1972, p. 459.

19 Sean Cubitt, *The Practice of Light*, Leonardo Book Series (Cambridge, MA: MIT Press, 2014). p.256.

20 Gibson, 1979, p. 243.

21 Ibid., p. 63.

22 'Light' *Oxford Reference*, available at: <[https://www.oxfordreference.com/view/10.1093/acref/9780199571123.001.0001/m\\_en\\_gb0470230](https://www.oxfordreference.com/view/10.1093/acref/9780199571123.001.0001/m_en_gb0470230)> [accessed 1 July 2019].

23 Ibid.

24 Ibid.

25 Ibid.

26 David A. Grandy, *The Speed of Light: Constancy and Cosmos* (Bloomington: Indiana University Press, 2009), p.50.

27 Ibid.

28 Gibson, 1979, p. 51.

ecological approach to visual perception is predicated.

Light is a stream of photons; it is variable wavelengths in the visible spectrum of colour; it is a rainbow; it is sun on skin, the emanation of a fluorescent tube, and a 'certain slant of light on winter afternoons'<sup>29</sup> that inspires poetry. No single description, medium, discipline, system, or worldview can offer a definitive explanation of light. The nature of light is inherently ecological.

## Light-perceiver-environment nexus

The light-perceiver-environment nexus is a neologism I have developed specifically for this research. The light-perceiver-environment nexus (Section 5.3: Finding 06, p. 134) builds on two of Gibson's propositions. First, the 'animal and environment make an inseparable pair',<sup>30</sup> which Gibson defines as a reciprocal 'mutuality'.<sup>31</sup> Second, the environment is defined as a triad of medium, substances and surfaces<sup>32</sup> which includes the reverberating flux of light in the medium'.<sup>33</sup> The term light-perceiver-environment nexus is applied in this thesis to refer to this systemically entwined interrelation between light and perceiver.

## Observation

In this research, observation is defined as an attentive and intentional perceptual interaction with the world, undertaken with the purpose of increasing understanding through the acquisition of specific information. Framed by Gibson's ecological worldview, the act of observation and the role of the observer are governed by the principles of reciprocity and mutuality. In this research, observation is situated within the ecological interrelation of the light-perceiver-environment nexus. Observation can be understood as perception with intent, in which the observer is 'an active and creative force shaping the stimuli'<sup>34</sup> that defines the information available within the observed environment. Gibson's theory of differentiation<sup>35</sup> suggests that repeated exposure to specific information can increase knowledge, as information is perceived in new and/or different ways.<sup>36</sup> The process of observation can facilitate perceptual learning and improve knowledge acquisition through refinement and attunement.

29 Emily Dickinson, 'There's a Certain Slant of Light' [1890], in *A Choice of Emily Dickinson's Verse* (London: Faber and Faber, 1986).

30 Gibson, 1979, p. 8.

31 Ibid.

32 Ibid., p. 22.

33 Ibid., pp. 22-23.

34 Flach and Holden, 1998, p. 92.

35 James J. Gibson and Eleanor J. Gibson, 'Perceptual Learning: Differentiation or Enrichment?', *Psychological Review*, 62 (1955), 32-41.

36 Herbert L. Pick, 'Eleanor J. Gibson: Learning to Perceive and Perceiving to Learn', *Developmental Psychology*, 28.5 (1992), 787-94 (p. 790).

### Subjectivity / Objectivity

In the reciprocal mutuality of Gibson's ecological vision the 'supposedly separate realms of the subjective and the objective are considered poles of attention'.<sup>37</sup> Perceiving an environment entails co-perceiving two concurrent perspectives: 'where one is in the world'<sup>38</sup> and the experience 'of being in the world at that place'.<sup>39</sup> Neither one is subjective, nor is it objective. From this ecological position the 'dualism of observer and environment is unnecessary'.<sup>40</sup> Co-perception of the self and the environment cuts across the dichotomy of subjective-objective and reveals its inadequacy.<sup>41</sup> Perception is co-perception and therefore one must conclude 'that there is only subjectivity, and that "objectivity" is itself a construction'.<sup>42</sup>

### Unconventional Affordance

In this study, an unconventional affordance is new knowledge which signifies perceptual development and demands a renewed description of the world. Building on Gibson's original definition of affordances as what an environment offers or provides a perceiver<sup>43</sup> (Section vi: Affordances, p. 22), contemporary ecological psychology applies a sociocultural perspective and introduces 'the concept of canonical affordances',<sup>44</sup> which are affordances that are considered 'conventional and normative'<sup>45</sup> within a specific cultural context. Psychologists Withagen and van der Kamp (Section 2.4.7, p. 73) define 'unconventional' affordances<sup>46</sup> as those which break with convention and generate new forms of meaning, interaction or knowledge. The discovery of unconventional affordances<sup>47</sup> indicates perceptual maturation and learning<sup>48</sup> and invites novel ways of perceiving, understanding and responding to the world. Unconventional affordances are used in this research as a defining methodological principle (Section 3.3, p. 93) and as one of three evaluation criteria (Section 3.6, p. 99).

.....  
37 Gibson, 1979, p. 116.

38 Ibid., p. 200.

39 Ibid.

40 Gibson, 1979. p. 116.

41 Ibid., p. 129.

42 Hugh Dubberly and Paul Pangaro, 'How Cybernetics Connects Computing, Counterculture, and Design', in *Hippie Modernism: The Struggle for Utopia*, exh. cat. (Minneapolis.MN: Walker Art Center, 2015), 1–12 (p. 6).

43 Gibson, 1979, p. 127.

44 Alan Costall, 'Canonical Affordances in Context', *Avant: Trends in Interdisciplinary Studies* 3.2 (2012), 85-93 (p. 85)

45 Ibid.

46 Rob Withagen and John van der Kamp, 'An Ecological Approach to Creativity in Making', *New Ideas in Psychology*, 49 (April 2018), 1–6 (p. 4).

47 Ibid.

48 Gibson, 1979, p. 245.

## Chapter One

# Introduction

## 1.1 A Practice of Light

A long-held fascination with light was the starting point for choosing the interrelation between light, perceiver and environment as the topic of my research. Light has been integral to my artistic practice and served as subject, medium and inspiration throughout my twenty-five year artistic career. Light affords a connection and expression beyond language that has been fundamental to my interdisciplinary collaborations across art, science, moving image and performance.

The original motivation for this research was to expand my critical and theoretical understanding of light in relation to my artistic practice, but this investigation has taken me far beyond the initial goal. The final purpose of the research is to develop an ecological framework for practice-based artistic research which combines rigorous artistic and theoretical investigation to facilitate an education of attention through the experiential observation of light.

Light is central to this study. My practice-based artistic research<sup>49</sup> is undertaken through the direct perception of light. It is from this experiential position that I examine the systemically entwined interrelation between light and perceiver, attend to my research questions, define the research terrain, formulate my research methods, and draw my conclusions. I return to the experience of being in light, time and time again, to clarify and refine the research trajectory. Light is inherently ecological: it cannot be categorised within the limits of a single medium, genre or disciplinary perspective. During the early stages of my research, it became apparent that I required a research methodology for studying light which could accommodate a syncretic and interdisciplinary approach. Over time and through repeated introductions, James J. Gibson's book *The Ecological Approach to Visual Perception* emerged as the most suitable foundation for this experiential investigation of light.

This introductory chapter outlines the critical ecological terrain in which my light-based research resides (Section 1.3, p. 30), and offers an overview of how Gibson's ecological theory is positioned as a methodological approach within this practice-based artistic enquiry (Section 1.4, p. 37). I articulate the original contribution to knowledge this research strives for (Section 1.5, p. 9) and provide a summary of the structure of the thesis (Section 1.6, p. 39). First, I specify the research questions that drive this enquiry.

## 1.2 Research Questions

James J. Gibson's ecological approach to visual perception provides the methodological foundation for this artistic research study. The practice of observing light is central to this investigation and is integrated with a concurrent theoretical enquiry to form a reciprocal dialogue between analytical and experiential knowing. It is from this position that I formulate the following two research questions:

.....  
 49 Carole Gray and Julian Malins, *Visualizing Research: A Guide to the Research Process in Art and Design* (Aldershot; Burlington, VT: Routledge, 2004).

1. Which principles and concepts from Gibson's ecological approach to visual perception might be adapted and applied to frame ecological artistic research that facilitates an education of attention through the rigorous observation of light?

2. What practice-based methods emerging from a Gibsonian research framework might be applied through artistic practice to cultivate an ecological worldview?

In navigating a path through this ecological examination of light, every turn affords an opportunity for tangential discussion, ecological interrelation and new paths of enquiry. These research questions are designed to maintain focus on Gibson's ecological theory and ensure the investigation can address the breadth of this subject whilst delivering concise research outcomes and findings that culminate in an original contribution to knowledge. The development and application of a Gibsonian framework for practice-based ecological artistic research is the primary contribution to knowledge emerging from this enquiry (Section 1.5, p. 39).

### 1.3 Defining an Ecological Terrain

Having established my research questions, I now present an overview of the critical ecological terrain in which I situate my light-based artistic research.

#### 1.3.1 Establishing a Line of Enquiry

An ecological approach to practice-based artistic research focused on the attentive observation of light does not naturally adhere to limitations. To observe light ecologically is to embrace a holistic perspective in which systemic interconnection, mutuality and reciprocity afford a seemingly infinite field of potential interactions. From my own experiential perspective light is inherently knowable; however, elucidating the entwined interrelation between light and perceiver requires an examination of a multiple intersecting and complex ideas. To position my research within this expansive terrain, I use James J. Gibson's ecological approach to visual perception to focus and define the specific line of enquiry this study navigates. Tracing a Gibsonian path through a broad ecological terrain allows this research to examine a syncretic field of interconnected theories, practices and approaches which inform and influence the critical thinking and research practices that lead to my contribution to knowledge (Section 1.5, p. 39). This thesis charts the research journey, guiding the reader by elucidating key points along the way. Light remains ever present in this investigation.

#### 1.3.2 A Brief Introduction to James J. Gibson

My initial introduction to James J. Gibson's ecological thinking was through two books about light from the scientific perspective of contemporary physicists David A. Grandy<sup>50</sup>

50 David A. Grandy, *The Speed of Light: Constancy and Cosmos* (Bloomington: Indiana University Press, 2009),

and Arthur Zajonc.<sup>51</sup> My second encounter with Gibson's ecological approach was through the Information Experience Design (IED) programme at the Royal College of Art which included Gibson's writing in the course reading list. Gibson's ecological paradigm also emerged as a primary influence in James Turrell's light-based artworks and in the interdisciplinary explorations of anthropologist Tim Ingold. These various enquiries into light, experience, perception and ecology had a shared foundation in Gibson's ecological approach which prompted me to investigate Gibson's ecological theory for myself.

Gibson's seminal work *The Ecological Approach to Visual Perception* was published in 1979, and as I discuss in Section 2.3.5 (p. 49) this highly controversial text polarised mainstream psychology,<sup>52</sup> earning Gibson a reputation as a maverick within his field. Whilst Gibson's own discipline initially rejected his ecological propositions, his approach was integrated into the theories of ecology and interdisciplinarity that were in abundance in American art, design and architecture<sup>53</sup> during the 1960s and '70s. Gibson's ecological vision offered artists a new way of framing their experiential practice beyond the boundaries of a single genre, medium or discipline.

By adopting a foundation in Gibson's theory, I anchor my experiential research in a long-established ecological artistic tradition that begins with Gibson's influence in the 1960's and '70's and carries through to the contemporary artistic contexts that frame this study. This ecological lineage, the core principles of Gibson's ecological theory and the specific Gibsonian line of enquiry I pursue are all examined in further detail in Chapter Two: Establishing an Ecological Context (pp. 41-88).

#### 1.3.3 A Syncretic Position in Information Experience Design

I have chosen to situate my research in the Information Experience Design (IED) programme of study at the Royal College of Art. IED offers an academic context which serves as a point of intersection for different modes of thinking and multiple creative approaches that correspond with my own interdisciplinary artistic practice. The IED programme introduced me to Gibson's '*Theory of Affordances*'<sup>54</sup> and as I will evidence in Chapter Two (Section 2.5, p. 82), the origins of IED's thinking can be traced, in part, through the artistic movements and critical trajectories that carried Gibson's ecological paradigm into contemporary artistic discourse.

51 Arthur Zajonc, *Catching the Light: The Entwined History of Light and Mind* (New York, NY: Oxford University Press, 1995).

52 J. A. Fodor and Z.W. Pylyshyn, 'How Direct Is Visual Perception? Some Reflections on Gibson's "Ecological Approach"', *Cognition*, 9 (1981), 139–96; R.N. Haber, 'Perception: A One Hundred Year Perspective', in *Perception: A One Hundred Year Perspective*, ed. by Sigmund Koch and David E. Leary (Washington, DC: American Psychological Association, 1985); Edward S. Reed, *James J. Gibson and the Psychology of Perception* (New Haven, CT: Yale University Press, 1988).

53 Charissa Terranova, 'Operational Blindness in the Twentieth Century: The Emerging Digital Image in Art from Gestalt to Distributed Network' (presented at the RENEW: Digital Arts Festival and Conference, Copenhagen, Denmark, 2013), pp. 1–5 <[https://www.academia.edu/5776350/Operational\\_Blindness\\_in\\_the\\_Twentieth\\_Century\\_The\\_Emerging\\_Digital\\_Image\\_in\\_Art\\_from\\_Gestalt\\_to\\_Distributed\\_Network](https://www.academia.edu/5776350/Operational_Blindness_in_the_Twentieth_Century_The_Emerging_Digital_Image_in_Art_from_Gestalt_to_Distributed_Network)> [accessed 12 July 2019].

54 James J. Gibson, *The Ecological Approach to Visual Perception* (New York, NY: Taylor and Francis, 1979), pp.127-146.



The IED programme combines theory and practice from contemporary art, design, journalism and the social and physical sciences. This syncretic approach reflects what artist and theorist Roy Ascott described in *Syncretic Reality*<sup>55</sup> as 'a plurality of difference' that maintains cohesion whilst breaking boundaries.<sup>56</sup> The syncretism of the IED programme is conducive to my artistic research enquiry based on Gibson's ecological vision of light as it allows me to draw multiple threads of enquiry together from fine art, visual perception, ecological theory and the science of light. This combination of perspectives affords new ways of understanding my artistic practice which may not have been possible in a more conventional disciplinary context.

My research draws upon the core ideas and critical approaches fostered by the IED programme. Subjective observation and participation are key methods in IED scholarship that enable me as a practitioner-researcher to engage directly with the systems, ecologies and experiences I observe. Experiential knowledge is also fundamental to the IED approach in which theoretical investigation is complemented by rigorous engagement with practice-based research methods. Situating my research within IED allows me to apply and test these principles and approaches with a level of sophistication through the theoretical and practice-based processes I undertake in this doctoral research. This PhD investigation extends IED scholarship by cultivating an ecological approach, which contributes to IED's development as a potential field of enquiry by expanding the academic discourse within the programme.

### 1.3.4 Defining a Critical Ecological Terrain

To define the broader ecological terrain that influences and informs my Gibsonian research beyond IED, I identify a critical territory composed of a diverse network of theorists, researchers and practitioners engaged in critical practice-based and theoretical ecological investigation in the arts. Whilst a shared ecological foundation connects this network across disciplinary boundaries, currently, no cohesive definition exists to draw it together as a distinct field of enquiry. To describe this network, I adopt Richard Buchanan's concept of a 'community of inquiry'<sup>57</sup> and I use the term 'ecological artistic scholarship' to refer to this research community. In his book *The Ecological Eye*<sup>58</sup> Andrew Patrizio draws similar connections 'beyond the usual horizon line of disciplinary perspectives'<sup>59</sup> to assemble a survey of ecocritical histories and practices within an art-historical context that includes many of the theorists I refer to in the following section. Contemporary 'ecological artistic scholarship' builds upon the ecological approaches of Gibson and Kurt Lewin, the systems theory of Gregory Bateson, Humberto Maturana

55 Roy Ascott, 'Syncretic Reality: Art, Process, and Potentiality', *Drain*, 2.2 (2005) <[https://www.academia.edu/2590161/Syncretic\\_Reality\\_art\\_process\\_and\\_potentiality](https://www.academia.edu/2590161/Syncretic_Reality_art_process_and_potentiality)> [accessed 7 January 2020].

56 Ibid., p. 1.

57 Richard Buchanan, 'Design Research and the New Learning', *Design Issues*, 17.4 (2001), 3-23, (p. 23). <<https://doi.org/10.1162/07479360152681056>>.

58 Andrew Patrizio, *The Ecological Eye: Assembling an Ecocritical Art History* (Rethinking Art's Histories) (Manchester: Manchester University Press, 2019).

59 Ibid., p. 2.

and Francisco Varela, and the phenomenology of Maurice Merleau-Ponty. The ecological thinking of this generation continues to inform the debates and trajectories in contemporary ecological discourse in the arts.<sup>60</sup>

### An Established Ecological Foundation

In this thesis I make reference to Kurt Lewin, Gregory Bateson and Maurice Merleau-Ponty whose writing provided me with a theoretical foundation for examining experience prior to adopting Gibson's ecology of light as the foundation of my research. Gibson's thinking was strongly influenced by Kurt Lewin's ecological approach, which I discuss in detail in Section 2.3.3 (p. 47) and Lewin's action research model, which contributes to the Gibsonian framework I propose, is outlined in Chapter Three: An Ecological Methodology (p. 89-102).

Gregory Bateson's systems thinking has numerous points of intersection with Gibson's ecological approach. The concepts of mutuality, the co-perception of the self and the understanding of pattern as a means of differentiation are all evident in Gibson's concept of light as information. Despite these shared ideas, there is little evidence to show that Gibson's writing was directly influenced by Bateson. For this reason, Bateson's work is not examined in depth in this thesis. However, three ideas from Bateson's seminal text *Steps to an Ecology of Mind*<sup>61</sup> inform my investigation. First, Bateson's statement 'a difference which makes a difference'<sup>62</sup> contributes to my definition of the term information (Section vi: Information, p. 23). Second, the practice of observing a system from the perspective of a systemically entwined observer which Bateson examined in second-order cybernetics,<sup>63</sup> informs my observations of light undertaken in this research. Third, Bateson's concept of ecological aesthetics,<sup>64</sup> the process of 'perceiving patterns of part-whole relationships'<sup>65</sup> informs the way patterns of information are uncovered using my three artistic research methods (Section 3.5, p. 97).

60 Patrizio, 2019.

61 Bateson, 1972.

62 Bateson, 1972, p. 459.

63 Second-order cybernetics, as formalised by Margaret Mead in her paper 'The Cybernetics of Cybernetics', Margaret (Mead, Cybernetics of Cybernetics in H. Von Foerster, J.D. White, L.J. Peterson, and J.K. Russell (eds), *Purposive Systems*, (New York, NY: Spartan Books, 1968, pp.1-19.) and subsequently developed by Mead, Bateson and von Foerster, affords an application of cybernetic principles to the role of a systemically embedded observer. If first-order cybernetics is 'the science of observed systems', (Francisco Varela, 'Introduction in Heinz von Foerster, *Observing Systems: Selected papers by Heinz von Foerster*, edited by F. Varela (Santa Barbara, CA: Intersystems Publications, 1982), p.xi).

64 Gregory Bateson developed his framework of ecological aesthetics to understand and analyse relational systems through the recognition of patterns which unfold as parts of larger meta-patterns. Ecological aesthetics sits within second-order cybernetics, and is a dynamic means of observing and uncovering emergent patterns to derive understanding, meaning and knowledge within a system. Bateson's use of the term aesthetics does not follow the western artistic conventions of style; ecological aesthetics is concerned with the complementarity of 'matter (what things are made of) and pattern (how they are organised)'. (Jon Goodburn, 'An Ecology of Mind', *The Architectural Review* (27 March 2012) <<https://www.architectural-review.com/rethink/an-ecology-of-mind/8628251.article>> [accessed 22 February 2017]).

65 Peter Harries-Jones, 'Gregory Bateson's "Uncovery" of Ecological Aesthetics', in *A Legacy for Living Systems*, ed. by Jesper Hoffmeyer (Dordrecht: Springer International Publishing, 2008), pp. 153-67 (p. 164.).

Unlike Bateson's ecology of mind, Maurice Merleau-Ponty's phenomenology directly informed Gibson's ecological vision.<sup>66</sup> Gibson and Merleau-Ponty both examined lived experience from a subjective first-person point of view and sought to recover 'the study of vision to pre-reflective experience'.<sup>67</sup> There are clear philosophical parallels in their thinking, and I discuss Merleau-Ponty's influence on Gibson's ecological approach in Section 2.3.4 (p. 48). Despite this shared theoretical ground, this connection diverged in the way Gibson and Merleau-Ponty framed their ideas. Gibson's paradigm relied on direct observation of the world and used empirical methods to test his hypotheses, whereas Merleau-Ponty's experience of the world served as the foundation for his poetic linguistic explorations.

### Contemporary Ecological Artistic Scholarship

Building on these established ecological traditions, the contemporary perspectives and debates that simultaneously connect and divide the conceptual tenets of new materialism, ecofeminism, eco-aesthetics, dark ecology, deep ecology, grey ecology, ecocriticism, ecophilosophy, ecological art history, ecological anthropology and environmentalism all contribute to 'ecological artistic scholarship'. These diverse critical and disciplinary positions conform to DeLanda's description of an ecosystem as 'a complex assemblage of [...] assemblages'.<sup>68</sup> Together they create a new ecology of enquiry in which, following Ascott, 'each element enriches the power of all others within the array of their differences'.<sup>69</sup> Guattari's three ecologies, Naess' deep ecological idealism, Haraway's 'naturecultures',<sup>70</sup> Barad's quantum entanglement and agential realism, Braidotti's feminist posthuman and non-human relations, Bennett's vibrant matter, Fry's ontological design, Morton's bleak ecognosis, Nöe's perception and consciousness and Ingold's correspondences individually and together exert significant influence in contemporary artistic discourse. This 'community of inquiry'<sup>71</sup> is unified by a critical ecological approach to social, cultural, environmental, technological and perceptual systems across a range of artistic contexts, disciplines, genres and media. Whilst it is not possible to address the breadth and depth of the debates within contemporary ecological artistic scholarship in this thesis, this ecological territory

66 Harry Heft, *Ecological Psychology in Context: James Gibson, Roger Barker, and the Legacy of William James's Radical Empiricism Resources for Ecological Psychology* (Mahwah, NJ: Lawrence Erlbaum Associates, 2001) pp.116-123, 161. Grandy, 2009, p.129.

G. Dobromir, Lin Nie Dotov, and Matthieu M. De Wit, 'Understanding Affordances: History and Contemporary Development of Gibson's Central Concept', *Avant: Journal of Philosophical-Interdisciplinary Vanguard*, 3.2 (2012), 28-39.

Mitchell G. Ash and Thomas J. Lombardo, 'The Reciprocity of Perceiver and Environment: The Evolution of James J. Gibson's Ecological Psychology', *The American Journal of Psychology*, 103.1 (1990), 127-132. (p. 128).

67 Grandy, 2009, pp. 7-8.

68 Manuel DeLanda, 'Ecology and Realist Ontology', in *Deleuze/Guattari & Ecology*, ed. by Bernd Herzogenrath (Basingstoke UK : Palgrave Macmillan, 2009), pp. 23-41 (p. 40).

69 Ascott, 'Syncretic Reality: Art, Process, and Potentiality', *Drain Magazine*, 2.2 (2005)

70 Donna J. Haraway, *The Companion Species Manifesto* (Chicago, IL: University of Chicago Press, 2003).

71 Buchanan, 2001, p. 23.

provides the critical context in which my practice-based artistic research resides. To focus my study, I trace a Gibsonian line of enquiry through this expansive ecological terrain, selecting historical theorists whose work directly influenced Gibson's thinking and contemporary researchers and practitioners who examine and apply Gibson's theory in their own investigations.<sup>72</sup> This Gibsonian line of enquiry is examined in depth in Chapter Two (pp. 41-88).

Contemporary ecological artistic scholarship is predominantly theoretical and has a tendency to be mired in overly complex language. By way of example, Karen Barad argues in the context of new materialism that 'language has been granted too much power',<sup>73</sup> suggesting that 'every "thing" – even materiality – is turned into a matter of language or some other form of cultural representation'.<sup>74</sup> Anthropologist Tim Ingold concurs, but is highly critical of the new materialist stance, observing that materiality in a contemporary context requires that we 'get as far away from materials as possible'.<sup>75</sup> New materialism affords a contemporary interpretation of some of the concepts that underpin Gibson's ecological approach. It rejects the assumption of 'an inherent difference between human and nonhuman, subject and object, mind and body'<sup>76</sup> and adopts the premise that knowledge is derived through direct interaction with the environment. However, unlike Gibson's approach, new materialism prioritises information over experience and emphasises ideation and signification over direct engagement with the material world. Ingold proposes that Gibson's ecological approach may provide an alternate way forward,<sup>77</sup> offering a model for ecological enquiry that values experiential knowing over theoretical speculation and affords a counterpoint to the linguistic edifices that dominate contemporary ecological discourse in the arts.<sup>78</sup> In this thesis, I choose to use language, both textual and visual, that is transferable beyond academic contexts, in order that my research might contribute to ecological debates in broader cultural, socio-political, environmental domains.<sup>79</sup>

72 These theorists include Kurt Lewin (Section 2.3.3), Maurice Merleau-Ponty (Section 2.3.4), John Steer (Section 2.4.4), Joseph D Anderson (Section 2.4.5), Tim Ingold (Section 2.4.6), Rob Withagen and John van der Kamp (Section 2.4.7) and Andrew Patrizio (Section 2.4.8).

73 Barad, 2007, p. 132.

74 Ibid.

75 Ingold, 2007, p. 2.

76 Barad, 2007.

77 Ingold, 2007, p. 4.

78 Gibson himself, bemoaned the various philosophical and psychological rationalizations and intellectual confusion that obscured the artistic experience, and advocated a return to the direct experiential 'art of structuring light' (James Gibson, *The Senses Considered as Perceptual Systems* (Boston, MA: Houghton Mifflin Company, 1966), p.238).

79 Annette Arlander, 'Artistic Research and/as Interdisciplinarity', in *Artistic Research Does #1*, ed. by Catarina Almeida and Andre Alves, 1, 2016, 1–5. <<https://artisticresearchinstockholm.files.wordpress.com/2016/08/artistic-research-does-1-eng.pdf>> [accessed 27 July 2018]. Rebekah R. Brown, Ana Deletic, and Tony H. F. Wong, 'Interdisciplinarity: How to Catalyse Collaboration', *Nature News*, 525.7569 (2015), 315 <<https://doi.org/10.1038/525315a>>.

### Practice-based Ecological Artistic Research

There are a growing number of practice-based artistic research investigations that adopt an ecological foundation and contribute to contemporary ecological artistic scholarship. These contributions have a common ecological foundation and span a diverse range of disciplines, including fine art,<sup>80</sup> architecture,<sup>81</sup> moving image,<sup>82</sup> cultural studies,<sup>83</sup> performance studies<sup>84</sup> and sound art.<sup>85</sup> Of these studies, I was able to establish that three adopt a specific Gibsonian approach. Sandra Reeve's, Myrto Karanika's and Anders Sjölin's PhD investigations apply Gibson's paradigm to contribute new knowledge within their disciplines, whilst the underlying ecological foundation in Gibson's theory connects them across disciplinary boundaries. These three practice-based artistic research investigations contribute to the critical ecological territory I define in Chapter Two (pp. 41-88).

### An Ecology of Light

The contextual landscape that informs my research also relies on the writing of physicists David A. Grandy<sup>86</sup> and Arthur Zajonc<sup>87</sup> to situate Gibson's ecological understanding of light within the broader context of mainstream scientific definitions. Grandy's *The Speed of Light*<sup>88</sup> and Zajonc's *Catching the Light*<sup>89</sup> provide detailed descriptions of light as defined by contemporary physics: however, both authors incorporate Gibson's ecological perspective into their arguments to offer an expanded view of the systemically entwined interrelation between light and perceiver. The distinctions and correlations between the scientific definition and the experiential

80 Fiona Curran, 'Towards a Fractured Topography of the Present: Art, Ecology and the Political Economy of Speed' (unpublished Doctoral thesis, University College London), 2016). Myrto Karanika, 'Exploring Perceptual Matters - a Textile-Based Approach' (unpublished PhD Thesis, Royal College of Art, 2013).

81 Jon Goodbun, 'The Architecture of the Extended Mind: Towards a Critical Urban Ecology' (unpublished PhD Thesis, University of Westminster, 2011).

82 Charlotte Adele Davies, 'Landscapes of Ephemeral Embrace: A Painter's Exploration of Immersive Virtual Space as a Medium for Transforming Perception' (unpublished PhD Thesis, University of Plymouth, 2005). Joseph. D. Anderson, *The Reality of Illusion: An Ecological Approach to Cognitive Film Theory* (Carbondale and Edwardsville, IL: Southern Illinois University Press, 1996).

83 Lucille Nolan, 'Vision Science and the Visual Arts' (unpublished PhD Thesis, Northumbria University, 2008). David McConville, 'On the Evolution of the Heavenly Spheres' (unpublished PhD Thesis, Plymouth University, 2014). Mary Culpepper, 'I Make, Therefore I Am: Agency, Action, Affordance, and the Path to Creative Identity' (unpublished PhD Thesis, University of Westminster, 2018).

84 Sandra Reeve, 'The Ecological Body' (unpublished PhD Thesis, University of Exeter, 2008). Sarah Hopfinger, 'Performance (in) Ecology: A Practice-Based Approach' (unpublished PhD Thesis, University of Glasgow, 2017).

85 Anders Sjölin, 'Plastic Modes of Listening: Affordance in Constructed Sound Environments' (unpublished PhD Thesis, University of Westminster, 2011).

86 Grandy, 2009.

87 Zajonc, 1995.

88 Grandy, 2009.

89 Zajonc, 1995.

interpretation of light that Grandy and Zajonc both consider in their texts are neatly summed up in the following comparison by Richard A. Kasschau.<sup>90</sup>

Experiential and Physical Characteristics of Light	
Experience (information / implicit)	Characteristics (knowledge / explicit)
Hue (colour)	Wavelength
Brightness	Intensity
Saturation	Pureness

Table 1.1: The Distinction Between the Experiential and Physical Characteristics of Light (1985) Richard A. Kasschau.

### 1.3.5 Summary

In this section, I have introduced the critical context that surrounds and informs my ecological enquiry. I have situated my research in the syncretic approach of the Information Experience Design programme and defined the critical terrain I refer to as ecological artistic scholarship. I have stated my intention to use language that is accessible beyond specific academic contexts, and I offer my study as a counterpoint and complement to the predominantly theoretical approaches in ecological artistic scholarship. I have established that I will focus my line of enquiry by selecting theorists, artists and researchers whose work relates directly to Gibson's ecological paradigm. This Gibsonian path will be examined in detail in Chapter Two (pp. 41-88) where I summarise the primary tenets of Gibson's theory, position my research in a critical ecological artistic tradition and provide evidence of the gap in knowledge that my research addresses.

## 1.4 Gibson's Theory as a Methodological Approach

Following the contextual review in Chapter Two (pp. 41-88), the third chapter, An Ecological Methodology (pp. 89-102) will discuss how Gibson's ecological theory is adapted and applied as a research framework to facilitate my practice-based artistic enquiry. In this section, I offer a brief overview of the structure of the Gibsonian methodology that frames this ecological investigation of light.

Gibson's concept of an 'education of attention'<sup>91</sup> provides the epistemological foundation of my study. By educating attention through attunement and refinement it

90 Richard A Kasschau, *Psychology : Exploring Behavior* (Englewood Cliffs, NJ: Prentice-Hall, 1980), p. 189.

91 Gibson, 1979, p. 254.

is possible to improve the capacity of the perceptual system. As the perceptual system becomes increasingly sensitised to an expanded range of information, new knowledge emerges. The experiential knowledge derived from an education of attention is pivotal to the ecological methodology and framework for practice-based artistic research that I develop in this study. To define the methodological approach that governs this study I draw out key concepts from Gibson's ecological approach to visual perception and adapt them into the following set of six methodological principles (Section 3.3, p. 93):

- 01: Light as Information (Ecological Information)
- 02: A Perceptual Ecology (Ecological Knowing)
- 03: Attentive Observation
- 04: Ecological Pattern
- 05: A New Level of Description
- 06: Unconventional Affordances

To convert these principles into a framework for practice-based ecological artistic research, I translate them through the stages of Kurt Lewin's action research model (Section 3.4, p. 95, Table 3.1, p. 92). The resulting Gibsonian framework provides the conceptual and structural foundation for a series of four artistic research projects: *A Year of Light*, *The Old Lookout*, *Daylight Observations* and *Earth Below Me Sky Above*, which are used to test Gibson's ecological theory through practice-based artistic enquiry. These projects, as discussed in Chapters Four to Seven (pp. 103-180) employ three practice-based research methods: Durational Observation, Ecological Lens and Reflective Artistic Practice (Section 3.5, p. 97). These methods are specifically developed to facilitate 'an education of attention'<sup>92</sup> through rigorous and attentive observations of light.

The four artistic research projects serve a dual purpose; individually each project is a catalyst for 'an education of attention'<sup>93</sup> that examines the systemically entwined interrelation between light and perceiver. Combined these four projects operate as a case study which is used to evaluate the efficacy of the Gibsonian research framework. This approach follows the example set by artist-researcher Keith Armstrong, whose ecological artistic research projects are used as case studies 'to tease out the complex interrelationships between research and practice within [the] work'.<sup>94</sup> In my research, examining the four artistic research projects as a unified case study allows me to evaluate the Gibsonian ecological framework to draw out overarching conclusions in response to my research questions. The evaluation criteria I apply to analyse my artistic research projects and the final case study are specified in Section 3.6 (p. 99).

The Gibsonian methodological approach described here is positioned in the ecological terrain defined in Chapter Two (pp. 41-88) and detailed in Chapter Three (pp. 89-102).

.....  
92 Ibid.

93 Ibid.

94 Keith Armstrong, 'Sustaining the Sustainable? Developing a Practice and Problem-Led New Media Praxis', in *Practice-Led Research, Research-Led Practice in the Creative Arts*, ed. by Hazel Smith and Roger T. Dean, (Edinburgh: Edinburgh University Press, 2009), pp. 187-99, (p. 187).

## 1.5 Contribution to Knowledge

The Gibsonian framework for ecological artistic research that I present in this study constitutes an original contribution to knowledge. As I evidence in Chapter Two (pp. 41-88) Gibson's paradigm has had an ongoing influence in contemporary artistic discourse. Despite this, Gibson's ecological vision has not been developed as a transferable framework for practice-based artistic enquiry. In this research, I have drawn out, adapted and applied a set of Gibsonian principles to create a framework for ecological artistic research which is transferable and adaptable for other practitioner-researchers working in critical ecological contexts. This ecological framework incorporates three research methods: Durational Observation, Ecological Lens and Reflective Artistic Practice (Section 3.5, p. 97) which are applied to test the rigour and validity of the Gibsonian methodology and ecological framework through artistic enquiry.

Governed by the concepts of light as information and an education of attention, this study provides a working example of Gibson's paradigm as a methodological approach for practice-based artistic research. This contributes a new model of enquiry to the research community I define as ecological artistic scholarship (Section 1.3.4, p. 32). This contribution is supported by a body of evidence consisting of visual data sets and light-based artworks produced through my practice-based artistic enquiry. These research outcomes afford different types of knowledge which together produce a rich, multifaceted response to my research questions.

My study also contributes to Information Experience Design (Section 2.5, p. 82) by expanding critical discourse within the programme to include an ecological approach. Additionally, my Gibsonian methodology offers an apposite model for ecological research in response to a growing call within artistic research to move beyond traditional disciplinary approaches.<sup>95</sup> This gap in knowledge will be discussed in further detail in Section 2.6 (p. 84).

## 1.6 Navigating the Thesis

This thesis is set out over eight chapters. Each chapter and section of this thesis contributes a particular set of ideas, perspectives, information and process which together provide a comprehensive account of my research enquiry. The structure of this thesis is as follows:

**Chapter One: Introduction** (pp. 27-40) provides an overview of my research outlining the intention of the study and providing summaries of my critical position, methodological approach and original contribution to knowledge.

**Chapter Two: Establishing an Ecological Context** (pp. 41-88) follows a Gibsonian line of enquiry through a review of the literature, artistic research and practice that informs

.....  
95 Robin Mackay, 'Approaching the Contemporary Object', Keynote Address, Humanities and Beyond: Exploring the Frontiers of Interdisciplinarity, (University of York, 27th May 2016) <<http://humanandbeyond.sites.sheffield.ac.uk/programme>>, [accessed 10 December 2018]; Julian Klein, 'What Is Artistic Research?', *Journal for Artistic Research* (2017) <<http://jar-online.net/what-artistic-research>> [accessed 10 December 2018]; Arlander, 2016.

and influences my study. This review is divided into four sub-sections that provide a comprehensive description of the critical context that underpins my ecological artistic research. A detailed outline of this chapter is included in Section 2.1 (p. 43).

**Chapter Three: An Ecological Methodology** (pp. 89-102) provides a detailed account of the Gibsonian ecological research framework I develop in this investigation. It specifies the concepts and underlying ecological principles that form the methodological foundation of this enquiry. I explicate how these principles are translated to create the framework for practice-based artistic research. I outline the research methods employed to undertake a series of four artistic research projects. I conclude this chapter by specifying the evaluation criteria with which I analyse my practice-based investigations.

**Chapters Four, Five, Six and Seven** (pp. 103-180) provide accounts of my four artistic research projects which are governed by the Gibsonian research framework and undertaken through the attentive observation of light in response to my research questions. Combined, these four chapters provide an overview of the progression of my research process as the findings and new knowledge from one project provides the starting point for the subsequent investigation.

**Chapter Eight: Taking the Long View** (pp. 181-194) offers a summation of the research findings that emerge from my four artistic research projects. Following Armstrong's example of artistic projects operating as case studies these projects are reviewed cumulatively to evaluate the efficacy of Gibson's theory as a research framework for ecological artistic enquiry. In this final chapter, I elucidate my original contribution to knowledge, discuss the limitations of my study and present the future directions for my ecological artistic research.

In the following chapter I review the literature and artistic practices that define the critical territory this research resides in. I examine Gibson's theory in detail and articulate the influence his ecological paradigm has had on artistic discourse since his work was published in the late twentieth century.

## Chapter Two

# An Ecological Context

## 2.1 Introduction

'Light is the condition of all vision'<sup>96</sup> and 'the visual media are our most important explorations'<sup>97</sup> of this phenomenon. Light, visual perception and artistic enquiry are the focus of this chapter which reviews the literature, artistic research and practices that frame the critical context for my study. This contextual review is divided into five sections: I examine the key concepts of Gibson's theory to establish an understanding of his ecological vision of light; I situate Gibson's theory in a long tradition of ecological thought; I trace the influence of Gibson's ecological thinking through a syncretic trail of practice-based and analytical artistic research to demonstrate the relevance of Gibson's theory to contemporary ecological artistic scholarship; I situate the Information Experience Design programme of study within this Gibsonian ecological tradition, and finally I articulate the gap in knowledge that this research addresses.

## 2.2 Light as Information

Gibson's ecological approach to visual perception is predicated on his concept of the ambient optic array,<sup>98</sup> a structured arrangement of light which provides information about an environment. Gibson specifies the physical world in terms of a medium, substances, and the surfaces. Light travels through the medium from a source and is scattered, reflected or absorbed as it reaches a surface.<sup>99</sup> The environment 'is specified in the structure of *the light*',<sup>100</sup> as patterns of variation and difference alter the inherently uniform field of the optic array. In defining the ambient optic array, Gibson differentiates ambient from radiant light and considers that ambient light can itself be information.<sup>101</sup>

Gibson's ecological theory proposes that visual perception is the direct activity of gathering information from the ambient array of light,<sup>102</sup> and argues it requires neither mediation nor interpretation. Information is accessed via a process Gibson defines as 'information pickup'<sup>103</sup> which entails the sensory pickup of fluctuations or differences that specify the persistent structures within an environment,<sup>104</sup> and reveal variation over time. Gibson considers vision not a separate sense channel, but as part of a whole perceptual system that integrates the five modes of attention:<sup>105</sup> seeing, smelling, touching, tasting and listening.

.....  
96 Cubitt, 2014, p. 1.

97 Ibid.

98 Gibson, 1979, p. 51.

99 'The surface is where most of the action is. The surface is where light is reflected or absorbed, not the interior of the substance. The surface is what touches the animal [...] And the surface is where vibrations of the substances are transmitted into the medium'. (Gibson, 1979, p. 23).

100 Ibid., p. 63. (emphasis in original).

101 Gibson, 1979, p. 51.

102 Gibson, 1979, p. 247.

103 Ibid., pp. 238-263.

104 Ibid., p. 249.

105 Ibid., p. 244.

The intention and exploratory behaviour of a perceiver in the environment influences the quality and quantity of perceptual information available to them.<sup>106</sup> Movement is critical in information pickup as it affords more information than a static perspective.<sup>107</sup> In Gibson's worldview, 'perceptual information is intrinsic to the environment, not intrinsic to sensations in the perceiver's mind'.<sup>108</sup> However, the mutuality of perceiver and environment<sup>109</sup> ensures that the presence and actions of a perceiver influence the information and the affordances available in an environment. This reciprocity negates the 'dualism of observer and environment'<sup>110</sup> and cuts across the dichotomy of the subjective-objective divide<sup>111</sup> (Section vi: Subjectivity/Objectivity, p. 26).

The Gibsonian concepts of the ambient optic array, direct perception and information pickup define the ecological perception of light which underpins both the practice-based and theoretical aspects of this research. This foundation in the direct perception of light serves as the starting point for this contextual review.

## 2.3 An Ecological Lineage

### 2.3.1 A Long Tradition

The ecological concepts of the ambient optic array and direct perception were a radical departure from mainstream psychology in Gibson's era. His ecological theory of perception was controversial,<sup>112</sup> and Gibson was considered a maverick.<sup>113</sup> However, as I will show, Gibson's approach is derived from a long tradition of ecological thinking in philosophy and the physical and social sciences. I begin by outlining the core concepts that define Gibson's ecological paradigm: mutuality and reciprocity, both/and logic and direct perception.

### 2.3.2 An Ecological Foundation

James J. Gibson was a renowned, but controversial, twentieth-century American psychologist known for his work in the field of ecological visual perception. His seminal publication *The Ecological Approach to Visual Perception* (1979)<sup>114</sup> aimed to re-invigorate the understanding of visual perception by proffering 'a new level of description'.<sup>115</sup> Gibson's ecological paradigm broke with the mainstream discourse in his field of

106 Ibid., p.147.

107 Gibson, 1979, p. 2.

108 Braund, Michael James, 'The Structures of Perception: An Ecological Perspective', *Kritike: An Online Journal of Philosophy*, 2. 1.3 (2008), 123-44 (p.126) p. 133.

109 Gibson, 1979, p. 127.

110 Ibid., p. 116

111 Ibid., p. 116, 129.

112 J. A. Fodor and Z.W. Pylyshyn, 'How Direct Is Visual Perception? Some Reflections on Gibson's "Ecological Approach"', *Cognition*, 9 (1981), pp. 139-96; Haber, 1985; Reed, 1988.

113 Heft, 2001, p. xxvi.

114 Gibson, 1979.

115 Ibid., p.xii.

perceptual psychology by proposing a unified and reciprocal interrelation between perceiver, the act of perception and the environment. Gibson's perception is not 'the achievement of a mind in a body, but of the organism as a whole in its environment'.<sup>116</sup>

Gibson emphatically rejects the reductive analysis of Cartesian mind-body dualism,<sup>117</sup> advocating a holistic non-dualist approach. His theories of direct perception and information pickup were the antithesis of Descartes' model of perception, which unfolded through a 'linear chain of events beginning in the material world and [...] ending in the mind'.<sup>118</sup> For Gibson, the 'relation between the animal and the environment is best characterized as a mutuality and a reciprocity',<sup>119</sup> in which 'one's complementary relations to the world are not separable'.<sup>120</sup> Gibson conceives an environment as dynamic structures that manifest in perceiver-environment reciprocity.<sup>121</sup> In this context, visual perception is considered a direct exchange between a perceiver and their environment. Light is information: patterns of difference and variation in 'an integrated system of mutual constraint'.<sup>122</sup> Unlike the linear 'either/or' structure of Descartes' worldview, the reciprocity of Gibson's ecological theory derives from non-linear logic. Adopting 'both/and' reasoning, Gibson describes the world as multiple, divergent, interrelated and systemically interconnected ecologies. This non-linear ecological approach reveals 'a hybrid perspective that demands [...] a commensurate logic to apprehend its insights'.<sup>123</sup>

Experience is central to Gibson's ecological approach, which seeks to recover primal, pre-analytic reality from theoretical abstraction.<sup>124</sup> Observation, movement, repetition and change over time are pivotal in Gibson's investigations of 'the primitive experience of seeing'.<sup>125</sup>

Whilst Gibson's theory proffered a new approach in mainstream psychology of his era, his thinking was influenced by long-established ecological traditions. Ernst Haeckel coined the term ecology, or '*Oecologie*', in 1866, in his *Generelle Morphologie der Organismen* (General Morphology of Organisms)<sup>126</sup> to describe the field of 'biology concerned with the mutual relations among organisms with one another and with

116 Tim Ingold, *The Perception of the Environment* (London: Routledge, 2000), p.3.

117 Braund, 2008, pp.123-124; Flach and Holden, 1998, p.93.; Heft, 2001, p.xxii.

118 Braund, 2008, p.126.

119 Heft, 2001, p.109.

120 Gibson, 1979, p.171.

121 Braund, 2008, p.129.; Also see Gibson, 1979, p.129.

122 Braund, 2008, p.123-124.; Flach and Holden, 1998, p.124.

123 Harold Jenkins, 'Gibson's "Affordances": Evolution of a Pivotal Concept', *Journal of Scientific Psychology* (December 2008), 34-45 (p. 39).

124 Grandy, 2009, p.104-105.

125 Ibid., p.8.

126 Harry Heft, 'An Ecological Approach to Psychology', *Review of General Psychology*, 17.2 (2013), 162-67 (p.162); Ernst Haeckel, *Generelle Morphologie der Organismen: Allgemeine Grundzüge der Organischen Formen; Wissenschaft, Mechanisch Begründet durch die von Charles Darwin Reformierte Deszendenz-Theorie* (Berlin: G. Reimer, 1866).

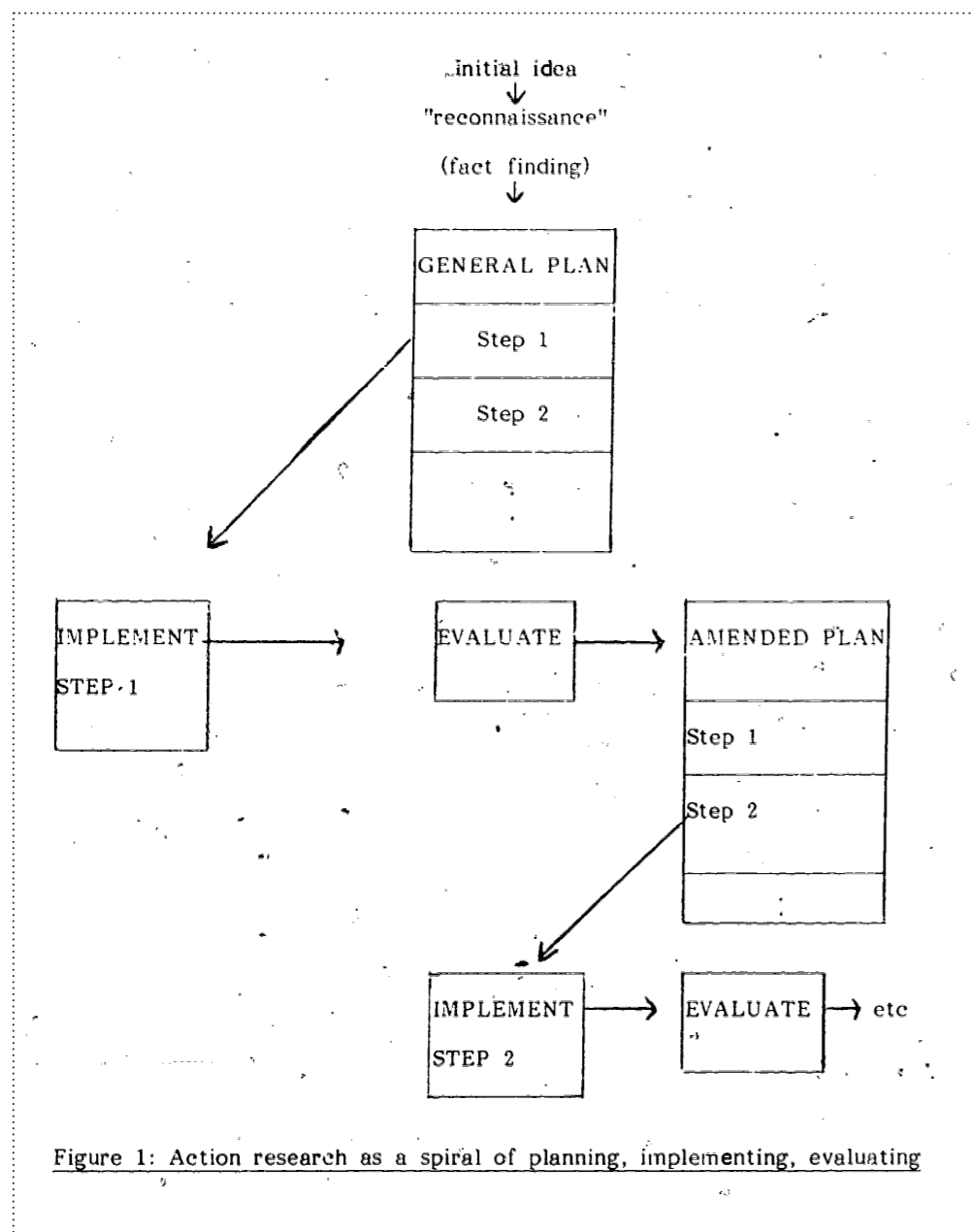

Figure 1: Action research as a spiral of planning, implementing, evaluating

Figure 2.1: Action Research as a Spiral of Planning, Implementing and Evaluating (1946), Kurt Lewin, redrawn by Stephen Kemmis (Sydney: Stephen Kemmis, 1990).

nonliving things'.<sup>127</sup> Ecological approaches in the physical sciences were adopted by theorists and philosophers in other fields. Alfred North Whitehead, William James and Kurt Lewin are among those who pioneered ecological thinking in the psychological and social sciences.<sup>128</sup> Kurt Lewin's writing was particularly influential on Gibson's development.<sup>129</sup>

### 2.3.3 Kurt Lewin's Psychological Ecology

Kurt Lewin's publication 'Psychological ecology' (1943)<sup>130</sup> was the first appearance of ecological theory in the discipline of psychology.<sup>131</sup> Following Alfred North Whitehead's philosophy, Lewin's pioneering work emphasised ecological relational dynamics in social psychology. His field theory<sup>132</sup> situated subjective, observer-centric experience 'in a constellation of co-occurring environmental influences',<sup>133</sup> defining a space which was 'located neither inside nor outside an organism, but which linked 'organism' to a field of which it was a part'.<sup>134</sup> Lewin's ecological psychology challenged psychologists to consider the interrelation between psychological processes and the environment in ways they had not previously encountered.<sup>135</sup>

Lewin's investigations were undertaken through 'action research', which he devised to study the comparative conditions and effects of various forms of social action.<sup>136</sup> Lewin's proposition that action was the outcome of the mutual convergence of multiple personal and environmental influences, was 'a critical step'<sup>137</sup> in the development of ecological psychology. Lewin's action research model was based in iterative experiential investigation and consisted of 'analysis, fact-finding, conceptualisation, planning, execution, more fact-finding or evaluation; and then a repetition of this whole circle'.<sup>138</sup> Lewin proposed that new knowledge (theory) could develop from observing the effects

127 Robert J. Richards, *The Tragic Sense of Life* (Chicago, IL: The University of Chicago Press, 2008), in Heft, p.162.

128 A full account of Gibson's influences can be found in Heft, 2001.

129 Heft, 2001.

130 Kurt Lewin, 'Psychological Ecology', in *The People, Place, and Space Reader*, ed. by William Mangold et al. (New York, NY: Routledge, 2014), pp.17-21.

131 Heft, 2013, p.162.

132 Lewin's psychological field theory drew influence from Einstein's Theory of Relativity and other developments in the physical sciences (Heft, 2013, p.162); Kurt Lewin, 'Field Theory in Social Science; Selected Theoretical Papers', ed. by Dorwin Cartwright, *The Annals of the American Academy of Political and Social Science*, 276.1 (1951), 146-47.

133 Heft, 2001, p.205.

134 Peter Harries-Jones, *A Recursive Vision Ecological Understanding and Gregory Bateson* (Toronto: University of Toronto Press, 1995), p.63.

135 Heft, 2001, p.205.

136 Kurt Lewin, 'Action Research and Minority Problems', *Journal of Social Issues*, 2 (1946), 34-46. (p.35).

137 Heft, 2001, p.205.

138 Stephen Kemmis, 'Action Research in Retrospect and Prospect' (presented at the Australian Association for Research in Education, Sydney, Australia, 1980) <<https://eric.ed.gov/?id=ED200560>> [accessed 2 November 2019].



of actions in context.<sup>139</sup> Adopting Lewin's action research model (Figure 2.1, p. 46) as the basis of the Gibsonian framework for ecological artistic research (Section 3.4, p. 95) in this study affords a synthesis which anchors my investigation to this ecological tradition.

Lewin's concept of an ecological field of interrelations, his systems approach and his model for action research profoundly influenced Gibson's thinking<sup>140</sup> in three ways: the concept that 'action occurs within a field of objects and can only be adequately understood when examined with respect to their combined influences'; that 'seeing and doing are merged in the same experience'; and that behaviour has an intentional character, such that 'the purposes of the individual contribute [...] to how a feature is experienced'.<sup>141</sup>

These ecological principles were crucial to Gibson's approach. Following Lewin, Gibson argued for 'the kind of thinking that is beginning to be attempted in what is loosely called systems theory',<sup>142</sup> and his stated aim for *The Ecological Approach to Visual Perception*<sup>143</sup> was to establish a theoretical core from which a systems-based psychological approach might be established.<sup>144</sup>

### 2.3.4 A Phenomenological Influence

Gibson's ecological thinking was influenced by 'parallel currents'<sup>145</sup> in European philosophy. Gibson was sympathetic to Maurice Merleau-Ponty's phenomenology of perception and behaviour.<sup>146</sup> Merleau-Ponty's 'account of space, time and the world as we "live" in them'<sup>147</sup> is in accord with Gibson's ecological thinking. Merleau-Ponty considers the experience of being in the world as a systemic interrelation with it; he attempts to describe experience as it is without the causal explanations of mentalist traditions.<sup>148</sup> Like Gibson, Merleau-Ponty examines 'conscious experience as experienced from the subjective or first-person point of view',<sup>149</sup> and rejects the

.....

139 Ibid.

140 Reed, 1988, 75-77; Heft, 2001; Jenkins, 2008, 34-45.

141 Heft, 2001, p. 213.

142 Gibson, 1979, p. 2.

Gibson does not specify his influences in the field of systems theory but his connection with Kepes, Burnham, Bateson and the Haptic Unconscious (Section 2.4.2) brought him into contact with systems thinking and cybernetics. Additionally, Lewin's psychological field theory, which influenced Gibson's theoretical approach, was also fundamental to the systemic thinking that informed Gregory Bateson's ecology of mind. (Bateson Notebook 47/Nov. ip/i-Feb. 1972 in Harries-Jones, 1995, p. 63.)

143 Gibson, 1979.

144 Ibid., p. 2.

145 Ash and Lombardo, 1990, p. 128.

146 Ash and Lombardo, 1990, p. 128. Also see: Heft, 2001, pp.116-123,161; Grandy, 2009, p.129; Dotov, Nie, and De Wit, 2012, 28-39.

147 Heft, 2001, p. 117.

148 Ibid.

149 David Woodruff Smith, 2018.

objective-subjective dichotomy inherent in Western Cartesian philosophy.<sup>150</sup>

Merleau-Ponty and Gibson consider vision as an experience of light capable of dissolving the boundaries between the self and the world. 'The body is the vehicle of being in the world, and having a body is [...] to be involved in a definite environment'.<sup>151</sup> Gibson and Merleau-Ponty both seek to recover the understanding of vision to pre-reflective experience,<sup>152</sup> emphasising the mutual interrelation between light, perceiver and the environment as a means of knowing the world. 'We must take literally what vision teaches', Merleau-Ponty declares, 'through it we come in contact with the sun and the stars, that we are everywhere at once'.<sup>153</sup> For Merleau-Ponty, as for Gibson, light and being are concomitant, and visual perception is enacted through ecological interrelation.

Despite this correspondence between Gibson and Merleau-Ponty's thinking, there is a clear distinction between their approaches (Figure 2.2, p. 50) Merleau-Ponty adopts a convoluted lyrical language in his attempt to capture and express the lived experience of being in the world. He speaks of the mind and body as one being, but in analysing these from the viewpoint of mind<sup>154</sup> he diverges from a focus on lived experience and emphasises intellect over body and language over direct action. Conversely, Gibson's approach avoids language which is 'needlessly complex and attributes too much responsibility to [...] the intellect'.<sup>155</sup> Integration of experience and theory is critical in Gibson's ecological paradigm, which is governed by the premise that 'we experience the environment through our bodies, and reciprocally, we experience our bodies through engaging with the environment'.<sup>156</sup> In adopting Gibson's approach I situate my research in direct perception to prioritise experiential knowing, combining my perceptual and analytical knowledge through concurrent artistic and theoretical investigations.

### 2.3.5 Not Everyone Loves an Ecological Worldview

Gibson's ecological approach to visual perception polarised the field of psychology.<sup>157</sup> Gibson did not seek to present 'a settled and complete theory',<sup>158</sup> in a traditional academic sense. Rather, his academic career was dedicated to revealing 'a new range of problems and issues'<sup>159</sup> which challenged mainstream thinking in his discipline.

To accept Gibson's ecological approach meant relinquishing a commitment to the

.....

150 Heft, 2001, p. 116.

151 Maurice Merleau-Ponty, *Phenomenology of Perception* [1962] (London: Routledge & Kegan Paul, 2005), p.94. spelling in original

152 Grandy, 2009, p. 7-8.

153 Maurice Merleau-Ponty, 'The Eye and the Mind', in *The Primacy of Perception: and Other Essays on Phenomenological Psychology* (Evanston, IL: Northwestern University Press, 1964) p.187.

154 Reeve, 2008.

155 Braund, 2008, p.126.

156 Heft, 2001, p. 55.

157 Fodor and Pylyshyn, 1981, 139-96; Haber, 1985; Reed, 1988.

158 Reed, 1988. p. 313.

159 Ibid.

## One Blue Sky: Three Views

‘As I contemplate the blue of the sky...I do not possess it in thought...I abandon myself to it...I am the sky itself as it is drawn together and unified...my consciousness is saturated with this limitless blue’. Maurice Merleau-Ponty<sup>160</sup>

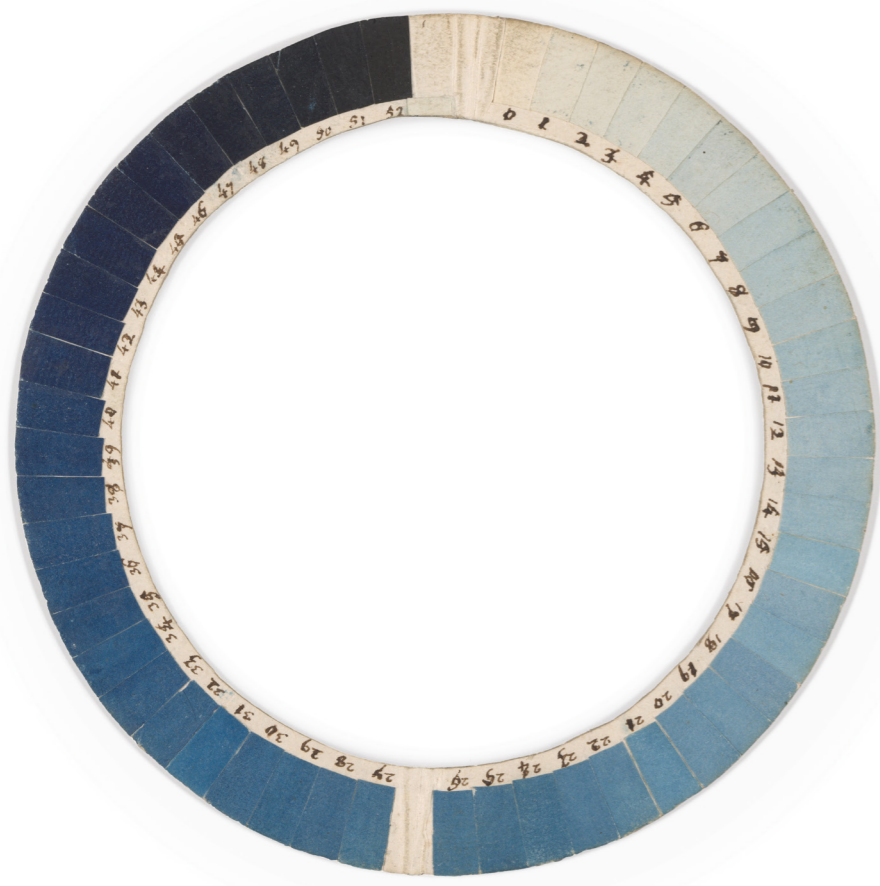

‘The eyes do tend to drift when the ambient light is homogeneous, as it is in the presence of...the blue sky or a dense fog or in ambient darkness’. James J. Gibson<sup>161</sup>

Figure 2.2: *Cyanometer* (1760), Horace-Bénédict de Saussure. Courtesy of the Bibliothèque de Genève, Arch. Saussure 66/7.

160 Maurice Merleau-Ponty, [1962], 2005, p.249.

161 Gibson, 1979, p. 215.

Cartesian philosophy which underpinned traditional Western psychological thinking.<sup>162</sup> According to his biographer Edward Reed, this was a step too far for many.<sup>163</sup> Gibson's approach was considered a radical unorthodoxy,<sup>164</sup> which appeared transgressive or inferior to those who subscribed to the establishment perspective.<sup>165</sup> Despite this, a number of Gibson's critics<sup>166</sup> adopt a conciliatory approach in their analysis of his work, suggesting that whilst they refute specific aspects of his theory, much of what he proposes 'is seen to be both true and important'.<sup>167</sup>

The main source of contention in Gibson's theory was the concept of direct perception, which his critics considered an oversimplification of the perceptual process,<sup>168</sup> Varela et al. argue that Gibson's theory is premised on 'the mistaken assumption that animal-environment mutuality is sufficient for direct perception'.<sup>169</sup> They dismiss Gibson's approach as a virtual monism.<sup>170</sup> Others cite Gibson's failure to address intentionality, information processing<sup>171</sup> and internal representation<sup>172</sup> as the primary shortcomings of his work.<sup>173</sup> Conversely, Gibson's advocates counter these arguments by suggesting that his work has been 'frequently misunderstood'.<sup>174</sup> There are three main reasons for this: interpretations based on linear logic could not accommodate the non-linear both/and reasoning<sup>175</sup> that defined Gibson's thinking; unlike traditional disciplinary investigations, Gibson's approach did not conform to a clearly demarcated line of enquiry: it was 'not one program but many different ones bearing uncertain connections',<sup>176</sup> and Gibson's ecological lineage in twentieth century philosophy and

162 Ibid., p. 319.

163 Ibid.; Heft, 2001, p. xxix.

164 Fodor and Pylyshyn, 1981, p.140.

165 Heft, 2001, p. xxix.

166 Fodor and Pylyshyn, 1981.; Joel Norman, 'Two Visual Systems and Two Theories of Perception: An Attempt to Reconcile the Constructivist and Ecological Approaches', *Behavioral and Brain Sciences*, 25.1 (2002), 73–96 <<https://doi.org/10.1017/S0140525X0200002X>>; C Wade Savage, 'Gibson's Reasons for Realism', *Cognitive Critique*, 4 (2011), p. 14. <[http://www.cogcrit.umn.edu/docs/Savage\\_11.pdf](http://www.cogcrit.umn.edu/docs/Savage_11.pdf)> [accessed 7 May 2018]; Tim Ingold, *Being Alive* (London: Routledge, 2011).

167 Fodor and Pylyshyn, 1981, p.141.

168 Ibid.; Savage, 2011, p. 14.; Shimon Ullman, 'Against Direct Perception', *Behavioural and Brain Sciences*, 3.3 (1980), 373–415.

169 Francisco J. Varela, Evan Thompson, and Eleanor Rosch, *The Embodied Mind* (Cambridge, MA: MIT Press, 1993).

170 Ibid., p.204.

171 Gombrich, 1989, p. 2.

172 Fodor and Pylyshyn, 1981.

173 Ibid.; Savage, 2011.; Ullman, 1980.; Ralph Norman Haber, 'A Theory of Perception', *Science, Book Reviews*, 209.4458 (1980), 799–800.; William M. Mace, in James J. Gibson, *The Ecological Approach to Visual Perception* (Classic Edition) (New York, NY: Taylor and Francis, 2015) pp. xxvii-xxviii.

174 Heft, 2001, p. xxiv; Also see: Thomas Natsoulas, 'Perceiving, Its Component Stream of Perceptual Experience, and Gibson's Ecological Approach', *Psychological Research*, 55 (1993), 248–57; Gombrich, 1989, 13–15.

175 Jenkins, 2008, 34–45. p.39.

176 Heft, 2001, p. xxvi.

psychology required fuller exposition.<sup>177</sup> The open-ended, syncretic nature of Gibson's controversial approach made it vulnerable to dismissal and accounted for much of the criticism of his ecological theories. Despite the controversy, Gibson's theory was pivotal in establishing the discipline of ecological psychology.<sup>178</sup> His ecological approach has been influential in disciplines as diverse as anthropology, art, architecture, design, film, performance, philosophy and sociology.<sup>179</sup> The impact of Gibson's ecological approach is unquestionable, yet the value of his theory as a framework for artistic research remains largely unexamined.

### 2.3.6 Summary

The once-radical concepts of mutuality, reciprocity and non-linear systemic thinking at the core of Gibson's ecological approach offer a valuable historical antecedent.<sup>180</sup> Decades after Gibson's final publication the controversial theories of this 'distinguished dissident'<sup>181</sup> offer an established ecological lineage for contemporary researchers. Gibson's theory affords a foundation for practice-based ecological artistic research which invites us to unlearn, to trust perceptual capacity<sup>182</sup> and to generate new knowledge in the crucible of lived experience.

## 2.4 Tracing a Gibsonian Ecological Path

### 2.4.1 Introduction

Despite initially being marginalised in mainstream psychology, Gibson's ecological thinking found an influential niche in the arts in America during the 1960s and '70s. From this beginning Gibson's theory wove an intermittent but persistent path through multiple trajectories that carried his concepts forward, to emerge fifty years later in the contemporary artistic discourse of Information Experience Design.

I trace Gibson's thinking through this syncretic trail of artistic practice, theory and research to examine the influence of his paradigm and demonstrate the potential of a Gibsonian ecological framework for practice-based artistic research. The structure of this section is best described as ecological; I define an interconnected field of influence, moving across disciplines to draw lines of connection between diverse examples of artistic practice, criticism, research and practices that draw on Gibson's ecological vision.

My focus remains with Gibson's thinking, but nested within this main line of enquiry I discuss selected light-based artworks by visual artists Roger Ackling, Uta Barth, Olafur

177 Ibid.

178 Lorena Lobo, Manuel Heras-Escribano and David Travieso, 'The History and Philosophy of Ecological Psychology', *Frontiers in Psychology*, 9 (2018), p.1.

179 William M. Mace, 2015, p. xxvii-xxviii.

180 Lobo, Heras-Escribano, and Travieso, p.1.

181 Gombrich, 1989.

182 Ibid., p.2.

Eliasson, Spencer Finch and James Turrell,<sup>183</sup> to illustrate how Gibson's approach to visual perception might apply in the creation and experience of artistic practice based on the observation of light. Gibson's core concepts of mutuality and reciprocity combine with the six defining principles (Section 3.3, p. 93) to bind these diverse threads together in a cohesive contextual field.

Gibson's idea of visual perception as a holistic interaction with the ambient optic array, the notion of an overlapping perceptual system and his definition of information as differentiation lend themselves to the artistic study of light. Artists with an interest in perception were 'urged to explore the implications of Gibson's ecological theory',<sup>184</sup> which was claimed to 'reward the thoughtful art historian'<sup>185</sup> and afford 'a revelation for the artist'.<sup>186</sup> Despite these recommendations, few art historians chose to cite Gibson's 'highly relevant psychological research';<sup>187</sup> as Andrew Patrizio observes, 'ecological concerns have traditionally been so little addressed in the art historical canon that even their absence has rarely been noted'.<sup>188</sup>

The use of Gibson's theory as a critical foundation in contemporary artistic research is equally limited. The three research examples I include here adopt Gibson's principles, but none articulate a cohesive or transferable Gibsonian research framework for practice-based artistic research. The following discussion provides evidence of the specific gaps in knowledge that this research might address.

### 2.4.2 The Haptic Unconscious

The scant interest in Gibson's ecological theory in formal critical artistic contexts did not restrict his ideas from making their way into artistic discourse via less traditional pathways. Caroline A. Jones<sup>189</sup> argues that Gibson's thinking 'influenced legions of American artists and designers in the late 1960s and '70s'.<sup>190</sup> As an example, Jones cites<sup>191</sup> a link to land artist Robert Smithson, facilitated by Paul Shepard's reference to Gibson's theory in his influential environmental book *Man in the Landscape*.<sup>192</sup> Renowned art critic and theorist Jack Burnham also referred to Gibson in *Beyond*

183 Not all the artists discussed in this section are known to be directly influenced by Gibson's ecological approach, however, the artworks I have selected as examples for discussion can all be seen to adhere to the Gibsonian principles outlined in Section 3.3.

184 Gordon L. Kensler, review of 'The Senses Considered as Perceptual Systems', by James J. Gibson, *Studies in Art Education*, 10.3 (1969), 63–64 (p. 64).

185 Samuel Y. Edgerton, review of 'The Senses Considered as Perceptual Systems', by James J. Gibson, *The Art Bulletin*, 51 (1969), 310–11 (p. 311).

186 Gerald Oster, review of Review of 'The Senses Considered as Perceptual Systems', by James J. Gibson, *Leonardo*, 1.1 (1968), 89–90 <<https://doi.org/10.2307/1571911>>.

187 Edgerton, p. 311.

188 Patrizio, 2019, p. 29.

189 'Caroline A. Jones, 'Modelling', in *Experience*, ed. by Caroline A. Jones, David Mather, and Rebecca Uchill (Cambridge, MA: MIT Press, 2016), pp. 13-33 (p. 27).

190 Ibid.

191 Caroline A. Jones, 'In reference to James J. Gibson', 9th July 2019, (personal email).

192 Paul Shepard, *Man in the Landscape: A Historic View of the Esthetics of Nature* (New York, NY: Knopf, 1967).

*Modern Sculpture*,<sup>193</sup> which anticipated the merging of natural structures and digital technologies and led to Burnham's concept of 'systems esthetics'<sup>194</sup> – his term for the emerging Systems art movement of the mid-1960s and early 70s. This period was characterised as a time of 'significant transitional activities'<sup>195</sup> in which 'art historians were contributing to analyses that traversed natural history and visual culture'<sup>196</sup> across multiple intersecting ecological, academic and cultural spheres.

Gibson's ecological approach to visual perception suited the interdisciplinary thinking and artistic practice of this era. The intersection between Gibson's perceptual theory and artistic enquiry was situated within a 'very specific passage of knowledge and pedagogy',<sup>197</sup> which art historian Charissa Terranova suggests has its origins in Moholy-Nagy's concept of the 'light-image'<sup>198</sup> and Gestalt psychology.<sup>199</sup> Terranova defines this territory as the 'haptic unconscious'.<sup>200</sup> This term can be seen to follow Gibson's notion of the 'haptic system',<sup>201</sup> which describes the unified perceptual 'sensitivity of the individual to the world adjacent to his body'.<sup>202</sup> As with Gibson's ecological theory, the 'haptic unconscious' was philosophically based 'in the union of mind and body', and emphasised 'experiential, intuitive, and proprioceptive knowing over static consciousness'.<sup>203</sup>

The 'haptic unconscious' operated as a network of influence and interconnection. Alongside Jack Burnham and Gregory Bateson,<sup>204</sup> artist, designer, and visual theorist György Kepes was a key figure in the 'haptic unconscious' network.<sup>205</sup> Kepes and the Center for Advanced Visual Studies which he founded at MIT in 1967 were 'central

193 Jack Burnham, *Beyond Modern Sculpture: The Effects of Science and Technology on the Sculpture of This Century*. (New York, NY: George Braziller, 1975).

194 Caroline A. Jones, 'Jack Burnham's "Systems Esthetics"', *Artforum*, (September 2012) <<https://www.artforum.com/print/201207/caroline-a-jones-on-jack-burnham-s-systems-esthetics-32014>> [accessed 2 November 2018].

195 Patrizio, 2019, p. 36.

196 Ibid.

197 Terranova, 2013.

198 Terranova uses the term 'light-image' to describe light-based artwork derived from analogue, electronic and digital image technologies. 'The term refers broadly to photography, the moving-image of film and today's video, light in motion of kinetic art, city lights seen while walking, driving, or aerially while in flight, the light-image of the television and computer screen, and the experiential light image of electronically based performance art'. (Terranova, 2013, p. 4.)

199 Charissa Terranova, *Art as Organism: Biology and the Evolution of the Digital Image* (London: Bloomsbury Academic, 2016). pp. 163-197

200 Terranova, 2013.

201 'The sensibility of the individual to the world adjacent to his body by the use of his body will here be called the haptic system. The word haptic comes from a Greek term meaning 'able to lay hold of' [...] The haptic system [...] is an apparatus by which the individual gets information about both the environment and his body. He feels an object relative to the body and the body relative to an object. It is the perceptual system by which animals and men are literally in touch with the environment'. (Gibson, 1966, p. 97).

202 Ibid., p. 97.

203 Terranova, 2013.

204 Patrizio, 2019, p. 37.

205 Terranova, 2016, pp. 163-197.

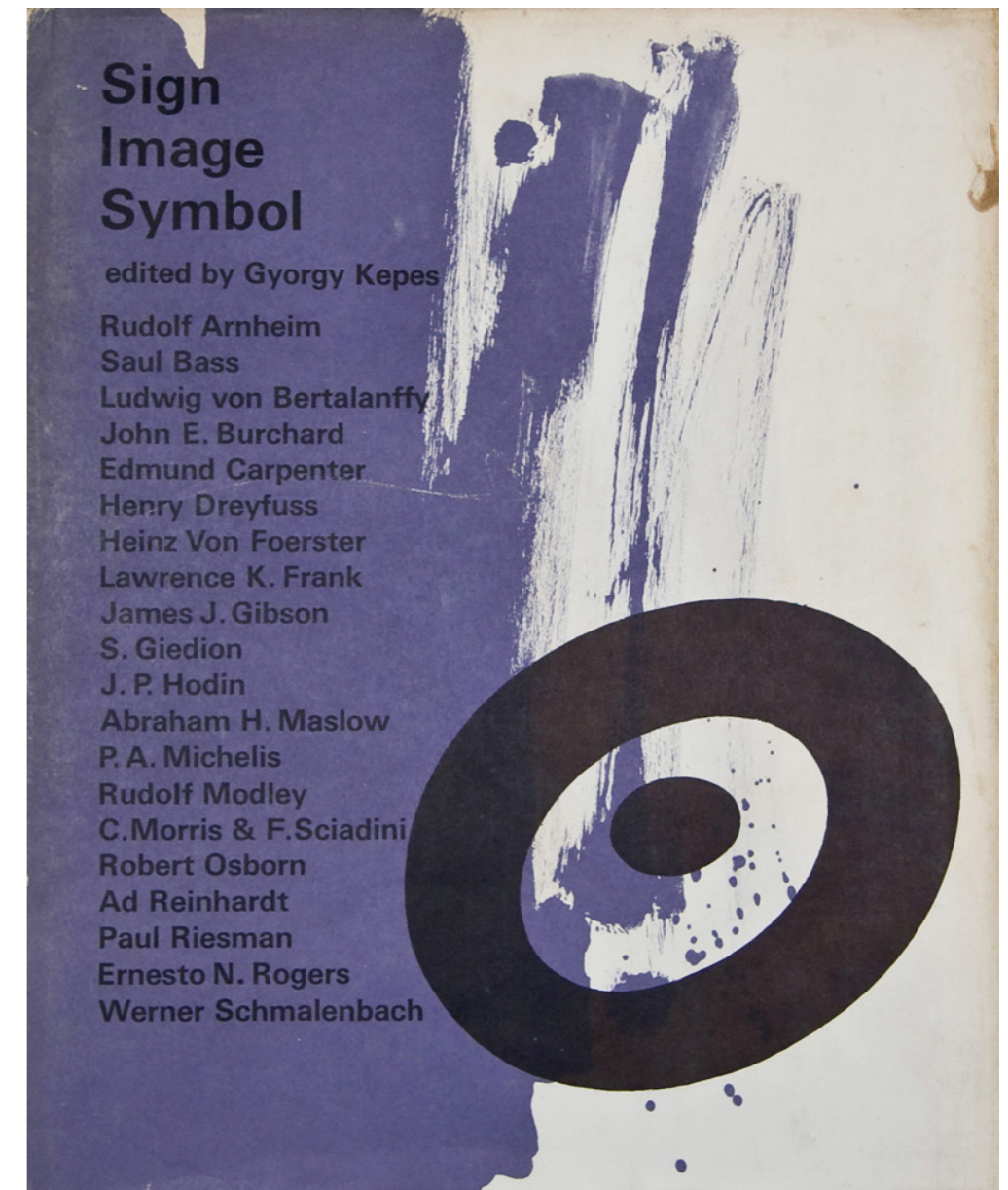

Figure 2.3: 'Sign, Image, Symbol', *Vision + Value Series* (1966), György Kepes (New York, NY: Braziller Publishing, 1966).

to the development of 'systems ecology' in relation to artistic creativity'.<sup>206</sup> Kepes' publication of the *Vision + Value* series<sup>207</sup> was highly influential. This set of seven exploratory compilations of essays by artists, designers, architects and scientists explored 'new directions in education, art, science, and visual communication'.<sup>208</sup> Gibson's essay *A Theory of Pictorial Perception* was included in the sixth volume, *Sign Image Symbol*<sup>209</sup> (Figure 2.3, p. 55). Kepes' publications offer 'a snapshot of an interdisciplinary phase of art history and visual culture',<sup>210</sup> that presented Gibson's ecological theory of perception alongside images and writings by the graphic designer Saul Bass, the musician John Cage, the physicist and philosopher Heinz Von Foerster, the art historian Ernst Gombrich and the architect and designer Buckminster Fuller. This catapulted Gibson's ideas beyond the limits of academic psychology, into the world of twentieth-century experimental art.<sup>211</sup>

The artists, theorists, scientists and critics who contributed to the 'haptic unconscious' interrogated perception through 'geometric abstraction, work with patterns, repetitive monochromatic shapes and kinetic form',<sup>212</sup> examining perceptual experience, ecological principles and information through exploratory interdisciplinary practices and technological and curatorial experiments. The collaborative thinking, artistic practices and public outcomes of the 'haptic unconscious' were concerned with the relationships between environment, light and perception and focused on 'the manner in which consciousness and knowing are spread across the body and environment with the aid of technology'.<sup>213</sup>

The artist James Turrell became interested in Gibson's ecological psychology<sup>214</sup> during this period. As a pioneer of the Los Angeles Light and Space movement in the mid-1960s,<sup>215</sup> merging art, science and technology was fundamental to Turrell's practice. Light is the material and perception is the medium in Turrell's geometric light projections (Figure 2.4, p. 58), immersive Ganzfeld<sup>216</sup> installations (Figure 2.5, p. 58) and Skyspaces (Figure 2.6, p. 58). Turrell structures light to create artworks which, following

206 Patrizio, 2019, p. 37.

207 *Vision + Value*, 7 volumes, ed. by György Kepes, (London: Studio Vista, 1965 - 72).

208 'György Kepes Papers', MIT - Art, Culture and Technology <<http://act.mit.edu/collections/visionandvalue/>> [accessed 11 July 2018].

209 *Sign, Image, Symbol (Vision + Value)*, 6, ed. by György Kepes, (London: Studio Vista, 1966).

210 Patrizio, 2019, p. 36.

211 György Kepes thinking influenced Gibson's understanding of visual language. Gibson refers to Kepes work and reproduces images from Kepes publications in *The Senses Considered as Perceptual Systems* (1966): 'The artist Kepes, in *The Language of Vision* (Chicago, IL: Theobald, 1944), has shown many of the variables of optical structure that yield variables of visual experience'. (Gibson, 1966, pp. 217, 240).

212 Terranova, 2016, p. 163.

213 Terranova, 2013.

214 Elaine A. King, 'Into the Light: A Conversation with James Turrell', *Sculpture*, 21.9 (2002) <<https://www.sculpture.org/documents/scmag02/nov02/turrell/turrell.shtml>> [accessed 2 September 2017].

215 Melissa E. Feldman, *Another Minimalism*, exh. cat. (Edinburgh: The Fruitmarket Gallery, 2015), p. 17

216 Gibson, 1979, p.151.

Gibson, situate a perceiver, the process of perception, the co-perceiving of the self, and the environment in a mutual and reciprocal exchange. Gibson's evaluation of his own Ganzfeld experiments could equally speak to the experience of Turrell's artworks.

What [...] I saw under these conditions could better be described as "nothing" in the sense of "no thing." It was like looking at the sky. There was no surface and no object at any distance. Depth was not present... [it] was an empty medium.<sup>217</sup>

Turrell's practice corresponds with the six Gibsonian principles specified in this research (Section 3.3, p. 93). However, whilst Turrell considers light as information he intentionally reduces the variable patterns in the ambient optic array to create uniformly filled light ecologies. In these spaces the deliberate lack of information focuses attention not on what light illuminates, but on the patterns of perception that emerge in the experience. Turrell offers his audience the unconventional affordance of seeing themselves seeing,<sup>218</sup> an ecological act of visual perception that becomes an integral part of the artwork.

Turrell was one of a new generation of artists, engineers and technologists that included Op Art's the New Tendencies,<sup>219</sup> light artists Julio Le Parc and Dan Graham,<sup>220</sup> the systems-based technological collaborations of Billy Klüver<sup>221</sup> and Experiments in Art and Technology (E.A.T.),<sup>222</sup> and Bell Laboratories,<sup>223</sup> whose exploratory artistic practices were shaped by Kepes' transdisciplinary publications,<sup>224</sup> Gibson's ecological vision and the interdisciplinary practices of the 'haptic unconscious'.<sup>225</sup>

This transdisciplinary network of art, science, technology, environment and experiential investigation continued to flourish and evolve in America throughout the 1970s. However, the artistic emphasis on ecological environmentalism was brought to a halt, as Patrizio and T.J. Demos note, with the rise of the political Right in the early 1980s.<sup>226</sup>

217 Ibid.

218 'Introduction', *James Turrell* <<http://jamesturrell.com/about/introduction/>> [accessed 2 September 2017] (para. 6 of 6).

219 Terranova, 2013.

220 'Two Correlated Rotations, Dan Graham, 1970-2', Tate <<https://www.tate.org.uk/art/art-works/graham-two-correlated-rotations-t01737>> [accessed 2 October 2018].

221 Anne Collins Goodyear, 'György Kepes, Billy Klüver, and American Art of the 1960s: Defining Attitudes Toward Science and Technology', *Science in Context*, 17.4 (2004), 611-35.

222 The 'haptic unconscious' and E.A.T. were also influential in the development of full-dome projection as an artistic medium. This immersive moving image format is mentioned in future research directions in Section 8.5 (p. 190). For further information about full-dome medium see: Michaela French, 'An Emerging Spherical Infinity', in *The New Infinity: Visual Art and Music in Planetariums*, ed. by Thomas Oberender, Berliner Festspiele (Köln: Buchhandlung Walther König, 2019), pp. 64-66.

223 Terranova, 2013.

224 Goodyear, 2004, p. 619.

225 Terranova, 2013.

226 T. J. Demos, *Decolonizing Nature - Contemporary Art and the Politics of Ecology* (Berlin: Sternberg Press, 2016), p. 38.; Patrizio, 2019, p. 45.

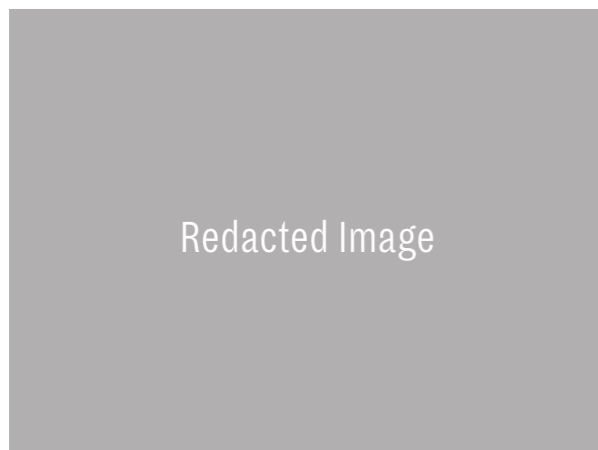
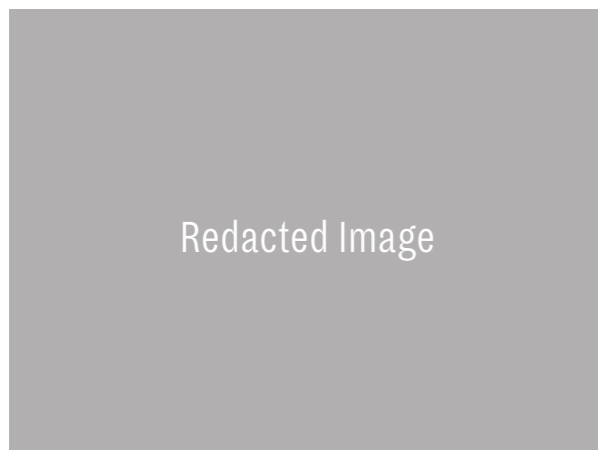
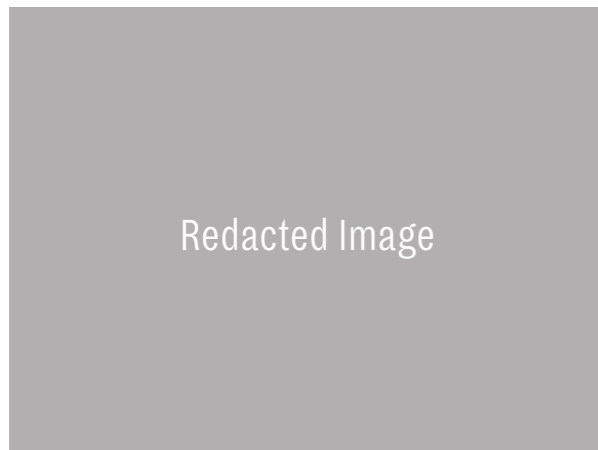

Figure 2.4: *Carn White* (1967), James Turrell, Photo: Florian Holtzherr.

Figure 2.5: *Breathing Light* (2013), James Turrell, Photo: Florian Holtzherr.

Figure 2.6: *Within Without* (2010), James Turrell, Photo: Michaela French.

As the relative idealism of the 'haptic unconscious' was dispersed, ecological thinking moved to the periphery of artistic practice. Despite this, specific aspects of the Systems art movement and Gibson's ecological paradigm found traction in other areas of creative practice and academic discourse.

### 2.4.3 Interpreting Affordances

One feature of Gibson's ecological approach which became highly influential in art and design was his theory of affordances. Widely seen as attributable to its later promotion by Donald Norman,<sup>227</sup> the influence of affordances shaped the way we engage with the modern world.<sup>228</sup> Norman, an engineer, psychologist and designer and a colleague of Gibson's,<sup>229</sup> saw the potential of affordances in enabling new modes of thinking and practice across industrial, interactive and experience design.

Gibson's original concept of affordances referred to what an environment 'offers the animal, what it provides or furnishes, either for good or ill'<sup>230</sup> (Section vi: Affordances, p. 22). Gibson considered affordances as relational interactions reflecting 'the complementarity of the animal and the environment'.<sup>231</sup> For Gibson, an affordance incorporated all action possibilities: those immediately 'visible, known, or desirable'<sup>232</sup> and those which emerged as a result of the perceptual capacity and behaviour of the perceiver.

Norman's *The Psychology of Everyday Things*<sup>233</sup> introduced Gibson's affordances to contemporary design.<sup>234</sup> Affordances were applied with the intention of using design to convey information about possible interactions with designed objects,<sup>235</sup> 'without the need for labels or instructions'.<sup>236</sup> Using affordances offered designers the potential to influence 'the relationship between a physical object and a person'<sup>237</sup> by determining the perceivable properties an object afforded, and thereby influencing the behaviour of the interacting agent.<sup>238</sup> The design community embraced the concept of affordances,<sup>239</sup> but Norman's approach proffered a distorted view of Gibson's theory: no longer the result of a reciprocal ecological interaction with the world, Norman's affordances were

227 Mace, 2014, p. xxvi.

228 Jones, 2016, p. 27.

229 Donald Norman, *The Design of Everyday Things*, rev and expanded ed. (New York, NY: Basic Books, 2013), p. 12.

230 Gibson, 1979, p. 127.

231 Jones, 2016, p. 27.

232 Donald Norman, 'Affordance, Conventions and Design (Part 2)', *Jnd.org*, 2008 <[https://jnd.org/affordance\\_conventions\\_and\\_design\\_part\\_2/](https://jnd.org/affordance_conventions_and_design_part_2/)> [accessed 22 June 2016].

233 Norman, 1988.

234 Kilbourne and Isaksson, 2007, p. 3.; Mace, 2014, p. xxvi.

235 Norman, 2013, p. 12.

236 *Ibid.*, p. 13.

237 *Ibid.*, p. 11.

238 *Ibid.*

239 *Ibid.*, p. 13.

a top-down design strategy which limited action possibilities to those made visible and desirable by the designer.

Following Norman, William Gaver adopted the concept of affordances in his influential *Technology Affordances*.<sup>240</sup> Gaver considered affordances to be a powerful tool for thinking about 'the interaction between technologies and the people who will use them',<sup>241</sup> but argued that Gibson's concept required development to 'be made precise and useful'.<sup>242</sup> Gaver redefined 'affordances as properties of the environment',<sup>243</sup> declaring them 'independent of perception',<sup>244</sup> and thus affordances became dissociated from the rich ecological interaction Gibson had proposed. As a result of Gaver's 'analytical move'<sup>245</sup> 'the concept of affordances has taken on multiple roles and continues to diverge from the ecological perspective advocated by Gibson'.<sup>246</sup> Norman now acknowledges<sup>247</sup> that the term affordance has become 'used in ways that had nothing to do with the original'.<sup>248</sup>

Reflecting a return to Gibson's ecological approach, sound artist Anders Sjölin's *Plastic Modes of Listening: Affordance in Constructed Sound Environments* adopts affordances as its theoretical foundation. Applying Gibson's approach as a framework for analysing contemporary sound art practice,<sup>249</sup> Sjölin examines the affordances available to a perceiver in 'constructed sound environments'.<sup>250</sup> Through a series of practice-based artistic research projects he produces cognitively rich multichannel installations combining localised sound with environmental audio<sup>251</sup> to offer a perceiver different and simultaneous affordances for exploration.<sup>252</sup>

Sjölin applies Gibson's affordances in two ways: he seeks out specific textural affordances in his audio recordings, based on the criteria of repetition, rhythm, placement, oscillation and layering.<sup>253</sup> The resonance of a wooden bowl,<sup>254</sup> for example, affords a specific rhythm which contrasts with layered acoustic reflections of the brutalist space of London's Barbican Centre. The same criteria are applied

240 William Gaver, 'Technology Affordances', in *Proceedings of the CHI, 1991* (New York, NY: ACM, 1991), pp.79-84

241 Ibid., p. 1.

242 Ibid.

243 Ibid. p. 2.

244 Ibid.

245 Kilbourne and Isaksson, 2007, p. 3.

246 Ibid., p. 4.

247 Norman, 2013.

248 Ibid., p. 13.

249 Sjölin, '2011, p. 8.

250 Ibid., pp. 8-9.

251 Ibid., p. 10

252 Ibid., p. 119.

253 Ibid.

254 Ibid., p. 77.

in constructing his immersive sound environments. Variable configurations of audio equipment and sound placements serve as installation sites for examining sound affordances in each installation environment.

Sjölin interprets affordances in two different ways. He defines sound as an ecological perceptual event,<sup>255</sup> and in recording sound and creating installations Gibsonian affordances serve as action possibilities that emerge through direct perceptual interaction with the environment. However, in analysing the completed sound experiences, Sjölin adopts Norman's interpretation, referring to sound events as affordances themselves, rather than examining these sound events for the affordances they offer a perceiver. These variable interpretations are indicative of the misinterpretation of Gibson's concept.

Sjölin's affordance-based investigation reflects an increasing interest in Gibson's approach for analysing the perceptual experience in contemporary sound and music.<sup>256</sup> The use of Gibson's theory as a research framework is of particular interest to my investigation; however, Sjölin's thesis does not present a clearly articulated Gibsonian research framework for practice-based artistic enquiry. This affords a gap in knowledge which my research responds to.

Norman's and Gaver's appropriated notions of affordances did not transpose Gibson's ecological principles into the design Zeitgeist, thus forfeiting an opportunity to cultivate ecological thinking within design discourse. However, the appropriation of Gibson's theory of affordances ensured that his name was carried forward into contemporary academic discourse in art and design.

#### 2.4.4 Affordances and Invariants in Artistic Experience

Unlike Norman and Gaver, art historian John Steer recognised the value Gibson's ecological paradigm might offer when applied as a framework for critical analysis in an art-historical context. Steer combines a Gibsonian interpretation of affordances with the concept of invariants<sup>257</sup> to propose an ecological framework for artistic analysis. Steer's *Art History and Direct Perception: A General View*,<sup>258</sup> offers a rare example of art criticism framed by a Gibsonian perspective.

In structuring his analysis, Steer uses Gibson's theory of invariants to analyse how meaning is embedded in an image during the creation process. The theory of affordances is then applied to examine how meaning is subsequently derived from the completed artwork. In discussing this proposition, I draw on selected light-based artworks by Uta Barth and Olafur Eliasson to illustrate how Steer's use of Gibson's theory might be applied in practice.

Steer suggests that an ecological approach to visual perception can serve as 'a vital

255 Ibid., p. 63.

256 W. Luke Windsor and Christophe de Bézenac, 'Music and Affordances', *Musicae Scientiae*, 16.1 (2012), 102–20 <<https://doi.org/10.1177/1029864911435734>>. A broader discussion of the influence Gibson's approach in the field of contemporary sound is beyond the scope of my research.

257 John Steer, 'Art History and Direct Perception: A General View', *Art History*, 12.1 (1989), 93–108 (p. 96).

258 Ibid.

tool in understanding how meaning is derived from images.<sup>259</sup> Following Gibson, Steer considers perception 'in terms not of sense data but of information pickup'<sup>260</sup> and argues that the meaning is derived directly from the perceptual process.<sup>261</sup> Through direct interaction a perceiver is able 'to pick up from the environment certain invariant factors which specify its enduring structure'.<sup>262</sup> 'Invariants are patterns'<sup>263</sup> of information in the environment which a perceiver differentiates from variable factors to observe change over time.

The creation of an artwork, Steer argues, is governed by the pickup and exploitation<sup>264</sup> of specific invariants. In constructing a visual image the artist isolates elements from 'the totality of the visual world'<sup>265</sup> by selecting 'one set of invariants from the total spectrum of visual experience'.<sup>266</sup> Through a process of abstracting and encoding the artist brings specific aspects of the visual experience to consciousness,<sup>267</sup> defining the viewer's focus of attention by selecting some invariants and not others.<sup>268</sup> Steer states that the artistic act of extracting invariants 'involves a kind of analysis not only of the visual world'<sup>269</sup> but of the way the artist experiences it.

In Uta Barth's photographs *Ground #38* (1994) (Figure 2.7, p. 63), *Ground #44* (1994) (Figure 2.9, p. 64), *Ground #46* (1994) (Figure 2.8, p. 63) light is the focus of attention. In specifying the invariants that define these images, Barth dematerialises conventional subject matter and emphasises light as a physical and ephemeral presence. The structural invariants of the environment she includes in these images exist within an almost homogeneous field of light. 'Haziness and unconventional framing'<sup>270</sup> imply spaces beyond the frame but simultaneously limit the perceptual information available to the viewer. Each image brings an acute awareness that Barth chooses to allow only selected aspects of her total perceptual experience to be seen.

This corresponds with two principles from Gibson's paradigm that Steer adopts in his analysis: 'pictures are unlike our experience of the visual world because they are flat and static and the world is three dimensional and experienced through movement over time'.<sup>271</sup> and 'pictures are in some sense like the visual world and of their very nature

.....  
259 Ibid., p. 106

260 Ibid., 95.

261 Ibid., p. 96.

262 Ibid., p. 95.

263 Ibid., p. 95.

264 Ibid., p. 97.

265 Ibid., p. 98.

266 Ibid., p. 98.

267 The data collection methods I employ in my artistic research projects correspond with Steer's idea of selecting invariants to abstract and encode specific aspects of the total spectrum of visual experience. See Chapters 4-7.

268 Steer, 1989), p. 97.

269 Ibid., p. 98.

270 Feldman, 2015, p. 28.

271 Steer, 1989, p. 101.

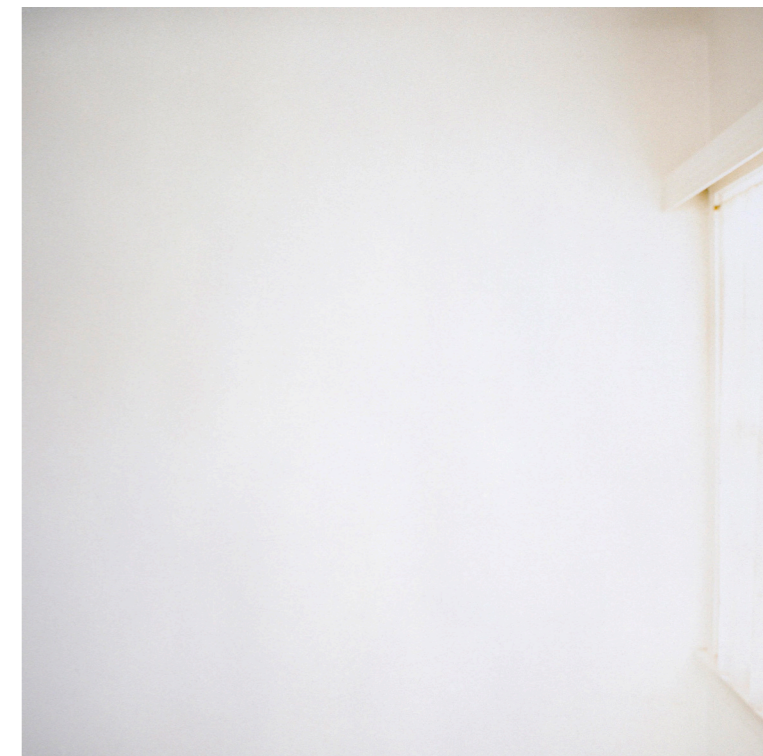

Figure 2.7: *Ground # 38* (1994), Uta Barth, Ektacolor print on panel (20 x 20 inches),

Figure 2.8: *Ground # 46* (1994), Uta Barth, Face-mounted pigment print on panel (19 1/2 x 21 inches). Courtesy of the artist and Tanya Bonakdar Gallery.





Figure 2.9: *Ground # 44* (1994), Uta Barth, Ektacolor print on panel (39 1/4 x 48 inches). Courtesy of the artist and Tanya Bonakdar Gallery.

refer to it'.<sup>272</sup> Barth's three photographs embody these two perspectives, creating a continuous dialogue between the static flattened world of the image and the imagined reality of the perceptual ecology it refers to.

Following Gibson, Steer contends that within an artwork 'individual invariants function [...] as referents to the real world'<sup>273</sup> regardless of the levels of realism or abstraction within an image. An artwork affords meaning by encoding the selected 'invariants which govern our ordinary perception'.<sup>274</sup> However, in the case of Olafur Eliasson's sculptural light installation *Model for a timeless garden* (2012) (Figure 2.10, 2.11 & 2.12, p. 66), the invariants the artist selects force the viewer to examine their 'ordinary perception'.<sup>275</sup> In *Model for a timeless garden* a series of small water fountains are illuminated by a high-speed strobe light in a darkened space. The strobing repetitions of light appear to freeze the flowing water momentarily; droplets suspend in mid-air, then fall, and freeze again in a seemingly impossible but beguiling real-time animation. The artwork plays with the continuity of visual perception, transforming the flow of ordinary perceptual information into a series of frozen iterative images that are suspended in time and carve the visual experience into discrete percepts.

The choice an artist makes in selecting invariants thereby enriches or narrows the information available for perception within an artwork. The selected invariants specify and evoke the properties of the world the artist intends to communicate.<sup>276</sup> The intention in both Barth's and Eliasson's artworks is to enable the viewer to focus on their own process of seeing instead of losing their attention to the subject they are looking at.<sup>277</sup> Whilst they adopt distinctly different approaches, both artists invite the viewer into an attentive and experiential observation of light.

As previously discussed (Section vi: Affordances, p. 22.), affordances are what an environment offers a perceiver. According to Gibson 'an affordance points both ways, to the environment and to the observer'.<sup>278</sup> The potential affordances of an artwork are determined by the invariants the artist has selected, in combination with the viewer's

.....  
272 Ibid.

273 Ibid., p. 99.

274 Ibid., p. 101.

275 Ibid.

276 Ibid., 100.

277 Russell Ferguson, 'Into Thin Air', in *Uta Barth: In Between Places*, ed. by Sheryl Conkelton, exh. cat. (Seattle, WA: Henry Gallery Association, 2001). p. 109.

278 Gibson, 1979, p.129.

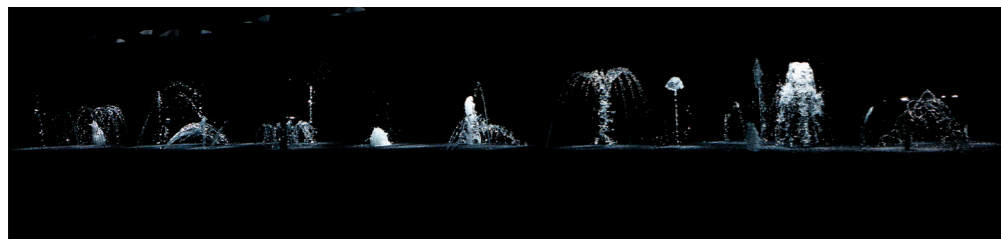

Figure 2.10: *Model for a timeless garden* (2011), Olafur Eliasson, Hayward Gallery, London, 2013, Photo: Marcus J Leith.

Figure 2.11: *Model for a timeless garden* (2011), Olafur Eliasson, Installation view: Studio Olafur Eliasson, 2011.

Figure 2.12: *Model for a timeless garden* (2011), Olafur Eliasson, Installation view: Pinchuk Art Centre, Kiev, 2011, Photo: Dimitry Baranov. Courtesy of Olafur Eliasson © 2011.

perceptual capacity and experience.<sup>279</sup> Steer argues that Gibson's 'way of thinking has significant implications for the visual arts',<sup>280</sup> precisely because from an ecological perspective perceiving the affordance of an artwork is synonymous with meaning, as 'purpose and meaning are incorporated into the act of perception itself'.<sup>281</sup>

Barth's photographs are a record of her process of attentive observation that offer a glimpse of a larger ecology. Barth's *Ground #38* (Figure 2.7, p. 63), *Ground #44* (Figure 2.9, p. 64) and *Ground #46* (Figure 2.8, p. 63) are studies of fluctuations in ambient optic array, captured in a single frozen moment, which afford the viewer an awareness of 'the act of perception itself as well as of one's own movement and the passage of time'.<sup>282</sup> Similarly, Eliasson's *Model for a timeless garden* (Figure 2.10, 2.11 and 2.12 p. 66) affords an awareness 'not just of light but of time and [...] presence in the world'.<sup>283</sup> This study of light and visual perception, stasis and flow, suspension and gravity offers an insight into the larger underlying ecology in which 'the apprehension of meaning is implicit in the perceptual act'.<sup>284</sup>

Steer's adaption of Gibson's principles of invariants and affordances as a framework for analysis provides an apposite example for my research. Steer advocates the value of applying Gibson's approach in analysing the artistic process and perceptual experience of a completed artwork from an ecological perspective. In examining Steer's application of Gibson's theory in relation to the selected light-based artworks discussed here, I demonstrate the suitability of a Gibsonian framework in evaluating my own practice-based artistic investigation.

#### 2.4.5 Overlapping Perceptual Systems and Patterns of Information

Another proponent of Gibson's ecological theory as a critical framework for analysis in the arts is cognitive film theorist and filmmaker, Joseph D. Anderson. *The Reality of Illusion: an Ecological Approach to Cognitive Film Theory*<sup>285</sup> was the first analysis

.....  
 279 Steer suggests in the context of visual art, affordances are partially influenced by a cultural dimension. The visual properties of an image, Steer contends, 'can only be understood in relation to the code within which they operate' (Steer, 1989, p. 105). By code, Steer refers to the cultural and social circumstances in which the work of art is produced, (Ibid.) interpreted and experienced. Steer suggests that in principle affordances as perceived 'uses, functions and connotations' (Ibid., p. 104) of an environment are not invalidated if that experience is culturally conditioned.' (Ibid.) This reflects Gibson's suggestion that it is 'a mistake to separate the cultural environment from the natural environment as if there were a world of mental products distinct from the world of material products' (Gibson, 1979, p.130). An ecological worldview must by definition, allow for cultural conditioning because it is derived from and integral to the perception of the environment. This may appear in contrast with Gibson's notion of direct perception; however, cultural conditioning can be accounted for in Gibson's proposition of an education of attention in which perceptual maturation and learning is possible through attunement, exploration and refinement (Rob Withagen and van der Kamp, 2018).

280 Steer, 1989, p. 102.

281 Ibid., p. 99.

282 Andrew Perchuk, in Ferguson, 2001, p. 109.

283 Adrian Searle, 'How the Hayward Gallery's Light Show Monkeys with Your Eyeballs', *Guardian*, 28 January 2013 <<https://www.theguardian.com/artanddesign/2013/jan/28/hayward-gallery-light-show-exhibition>> [accessed 15 March 2016].

284 Steer, 1989, p.96.

285 Anderson, 1996.

to propose a 'systematic ecological approach to film'<sup>286</sup> According to Anderson, a significant limitation in contemporary film theory<sup>287</sup> is the divide between film criticism and the interface between the film and the viewer. To address this gap Anderson applies Gibson's paradigm to examine 'the interaction between a spectator and the series of images and sounds that constitute a motion picture'<sup>288</sup> from the perspective of ecological perception.

Anderson adopts Gibson's premise of ecological perception as an 'ongoing dynamic interaction with the environment',<sup>289</sup> and applies the concepts of direct perception and ambient optic array to 'build an understanding of the ecology of cinema'.<sup>290</sup> The cinematic experience presents 'surrogate arrays to our visual and auditory systems',<sup>291</sup> and the information inherent in the patterns of light and sound are picked up directly by the perceptual system.<sup>292</sup> The innate perceptual drive to gather information, seek meaning and make sense of the world, Anderson contends, operates with the same anatomical structures and physiological processes in the cinematic experience as in the physical world.<sup>293</sup>

Anderson examines selected aspects of the cinematic experience that have previously 'resisted coherent explication'.<sup>294</sup> These include motion, depth, colour and visual orientation. In reviewing these elements Anderson combines Gibson's concepts of invariants and information pickup with selected cognitive research studies to scrutinise the systemic relationship between the viewer and the cinematic experience. Patterns of information are critical to the cinematic medium, which Anderson describes as 'bimodal'.<sup>295</sup> Building on Gibson's notion of an integrated perceptual system,<sup>296</sup> Anderson proposes that when information is perceived in 'two or more sensory modes simultaneously'<sup>297</sup> it results in a 'process of information comparison'.<sup>298</sup> The invariant properties perceived across sense modes serve to direct attention and establish patterns<sup>299</sup> in an active search for 'cross-modal confirmation'.<sup>300</sup> As Steer suggests,

.....  
286 Don Fredericksen, Review of *The Reality of Illusion: An Ecological Approach to Cognitive Film Theory*, by Joseph. D. Anderson, *Journal of Film And Video*, 51.3-4 (1999), 97-99 (p. 97).

287 Anderson, 1996, p. 3.

288 Ibid., p. ix.

289 Ibid., p. 44.

290 Fredericksen, 1999, p. 97.

291 Anderson, 1996, p. 111.

292 Ibid., p. 29.

293 Ibid., p. 44.

294 Ibid., p. 54.

295 Ibid., p. 80.

296 Gibson, 1979, p. 244; Gibson, 1966.

297 Anderson, 1996, p. 82.

298 Ibid.

299 Anderson, 1996.

300 Ibid., p. 82.

Anderson concludes that it is the selection of invariants that determine the patterns of information available to the viewer.<sup>301</sup> These invariants are part of a 'total spectrum'<sup>302</sup> of perceptual experience, but are enough to produce the patterns of information required to confirm 'the veridicality of filmic events'.<sup>303</sup>

Gibson's proposition of a unified, overlapping perceptual system incorporating the five sensory modes<sup>304</sup> also serves the conceptual foundation of textile artist Myrto Karanika's PhD, *Exploring Perceptual Matters* (2015). Karanika's research combines Gibson's unified perceptual system with recent 'neurobiological research on sensory integration'<sup>305</sup> to examine the experience of touch, hearing and vision in the field of responsive textiles.<sup>306</sup> Through practice-led artistic enquiry, Karanika examines the behaviour of participants as they interact with 'a touch-sensitive, sound-generating rug'<sup>307</sup> designed as a participatory interactive art installation. The textile rug is 'an integral part of the investigative process', providing a platform to study 'how different sensory information integrates into a meaningful percept'.<sup>308</sup>

Like Anderson, Karanika uses Gibson's integrated multi-modal perceptual system to analyse experience from multiple concurrent perspectives. Karanika's traditional scientific observation methods examine the sensory input and behavioural output of her research participants<sup>309</sup> from a distance. She records the participants' interactions with the rug using video and touch-sensor technologies embedded within the artwork. The collected data records the placement and observable actions of the participants, but does not incorporate subjective observations of their own perceptual experiences.

Karanika cites 'attentional focus'<sup>310</sup> and 'active exploration'<sup>311</sup> as crucial parameters for generating new knowledge through a direct perceptual process.<sup>312</sup> These findings correspond with my defining Gibsonian principles of Attentive Observation and A Perceptual Ecology (Section 3.3, p. 93); however, Karanika's conceptual foundation in Gibson's theory does not translate into her practice-based artistic investigation. Her research methods are neither ecological nor reciprocal, and offer little opportunity for perceptual learning or the discovery of unconventional affordances for either the participants or the researcher.

.....  
301 Anderson argues that an inherent propensity to search for patterns and rhythms that bridge perceptual modalities ensures that information carried across different modes is 'perceived as being generated by single event'. (Anderson, 1996, p. 86).

302 Steer, 1989, p. 98.

303 Anderson, 1996, p. 89.

304 Gibson, 1979, p. 244.; Gibson, 1966.

305 Karanika, 2013, p. ii.

306 Ibid., p. 100.

307 Ibid., p. ii.

308 Ibid., p. 3.

309 Ibid., p. ii.

310 Ibid.

311 Ibid.

312 Ibid.

By contrast, Anderson's critical examination demonstrates the value of applying Gibson's overlapping perceptual system<sup>313</sup> in analysing an artistic experience, and, like Steer, offers a more comprehensive and insightful example of how Gibson's paradigm can operate as a conceptual framework for examining artistic experience.

#### 2.4.6 An Ecological Art of Inquiry

The discussion unfolding in this section began with the 'haptic unconscious',<sup>314</sup> and I have traced Gibson's thinking through user-centred design, artistic experiences of light, art criticism, cognitive film theory and responsive textiles. In this sub-section, the discussion moves to anthropology and to the field of performance studies to examine a practice-based PhD that integrates Gibson's theory with the writings of anthropologist Tim Ingold.

Ingold encountered Gibson's theory in the early 1980s,<sup>315</sup> and the profound impact of Gibson's ecological paradigm is evident in many of Ingold's publications.<sup>316</sup> Beginning his career in the natural sciences, Ingold witnessed the surrender of science 'to the forces of neoliberalism',<sup>317</sup> and sought a counter-movement in the intersection of anthropology, art, architecture and design.<sup>318</sup> Ingold's examination of Gibson's theory afforded another pathway for this ecological vision to enter contemporary artistic discourse.<sup>319</sup>

Recently, Ingold has begun to question aspects of Gibson's theory: 'after my prolonged dalliance with Gibson's ideas', he says, 'I have myself latterly become a critic'.<sup>320</sup> Despite Ingold's current view, his extensive exploration of Gibson's theory is of value to this enquiry. Systemic interconnection, direct perception and reciprocity between a perceiver and their environment are the foundation of Ingold's thinking. Like Gibson, Ingold rejects the dualism of Cartesian philosophy, arguing for a renewed

313 Gibson, 1979, p. 244.; Gibson, 1966.

314 Terranova, 2013.

315 Ingold was introduced to Gibson's theory by ecological psychologist and Gibson's biographer, Edward Reed. (Tim Ingold, 'Back to the Future with the Theory of Affordances', *HAU: Journal of Ethnographic Theory*, 8.1–2 (2018), 39–44 (p. 39).

316 Withagen and John van der Kamp, 2018, p. 3.; Tim Ingold, 'Culture and the Perception of the Environment', in *Bush Base: Forest Farm: Culture, Environment, and Development*, ed. by David J. Parkin and Elisabeth Croll (London ; New York: Routledge, 1992), pp. 39–56.; Ingold, 2000. Ingold, 2007.; Ingold, 2011.; Ingold, *Making*, 2013.; Tim Ingold, *Correspondences* (Aberdeen: University of Aberdeen, 2017); Ingold, 2018.

317 Tim Ingold, 'From Science to Art and Back Again: The Pendulum of an Anthropologist', *Interdisciplinary Science Reviews*, 43.3–4 (2018), 213–227 (p. 223).

318 Tim Ingold, 'Search and Search Again: On the Meaning of Research in Art' (Centre for Contemporary Arts, Glasgow UK, 4 February 2018) 4:19, <<https://soundcloud.com/cca-glasgow/tim-ingold-search-and-search-again-on-the-meaning-of-research-in-art>> [accessed 10 December 2018].

319 Ingold, *Making*, 2013.; Ingold, 'Search and Search Again', 2018.

320 The basis of this change of view lies in what Ingold describes as 'a deep-seated asymmetry in Gibson's original approach to perception' (Ingold, 'Back to the Future with the Theory of Affordances', 2018, p. 42). This inconsistency, according to Ingold, is made manifest in the theory of affordances, which positions the perceiver as engaged in a dynamic exploration of 'their inexhaustible potentials' (Ibid.) whilst rendering the environment and the objects therein as 'effectively solidified', (Ibid.) inert and passively waiting for interpretation. I disagree with this interpretation, as Gibson clearly states that the perception of 'an affordance points both ways, to the environment and to the observer' (Gibson, 1979, p. 129).

understanding of our relations and responsibilities towards the environment.<sup>321</sup> Ingold is disdainful of the 'academic perversion' which prioritises abstract materiality over direct material experiences,<sup>322</sup> information over experience, and reason over intuition.<sup>323</sup> Advocating a shift away from the 'abstract ruminations of philosophers and theorists',<sup>324</sup> Ingold proffers 'an art of inquiry'.<sup>325</sup>

An 'art of inquiry'<sup>326</sup> describes an exploratory, attentive engagement with the world. It is a practice of open awareness, of attending to detail and responding to that which emerges through the act of being and observing.<sup>327</sup> Ingold's 'art of inquiry' unfolds through direct perceptual action as a perceiver 'proceeds along paths of observation'.<sup>328</sup> As with Gibson's 'education of attention',<sup>329</sup> in an 'art of inquiry' attentiveness allows a perceiver to cultivate awareness of their reciprocal interrelation with an environment.<sup>330</sup> In an 'information-rich world', attentiveness requires practice, as Herbert A. Simon proposed: 'a wealth of information creates a poverty of attention',<sup>331</sup> as attention is dispersed 'among the overabundance of information sources that [...] consume it'.<sup>332</sup> The purpose of an 'art of inquiry' is not to 'accumulate more and more information about the world, but to better correspond with it'.<sup>333</sup>

Sandra Reeve combines Gibson's concept of an education of attention<sup>334</sup> and Ingold's 'art of inquiry'<sup>335</sup> as the critical foundation of her practice-based PhD, *The Ecological Body* (2008).<sup>336</sup> Situated in the academic field of performance studies, Reeve's investigation cultivates embodied environmental awareness through movement to reveal the self as an intrinsic part of a complex environmental system.<sup>337</sup> Direct perception and mutuality underpin her enquiry, which adapts Gibson's theory using the 'ecological

321 Ingold, 2000, p. 40.

322 Ingold, 2007, p. 2.

323 Ibid., p. 3.

324 Ibid., p. 2.

325 Ingold, *Making*, 2013. pp. 6–8.; Ingold, 'From Science to Art and Back Again', 2018, p.10.

326 Ibid.

327 Tim Ingold, 'Search and Search Again: On the Meaning of Research in Art' (Centre for Contemporary Arts, Glasgow UK, 2018) - 22.15

328 Ingold, 2000, p. 229.

329 Gibson, 1979, p. 254.

330 Tim Ingold, 'Search and Search Again: On the Meaning of Research in Art' 2018, - 22.15

331 Herbert A Simon, *Designing Organizations for an Information-Rich World* (Baltimore, MD: Johns Hopkins University Press, 1971) ]40–41 <<https://zeus.zeit.de/2007/39/simon.pdf>> [accessed 16 December 2017].

332 Ibid.

333 Ingold, 2013, p. 7.

334 Gibson, 1979, p. 254.

335 Ingold, 2013. pp. 6–8.

336 Reeve, 2008.

337 Ibid., p. 2.

lenses of niche, pattern and emergence<sup>338</sup> as criteria for analysis. Reeve's use of the term 'niche'<sup>339</sup> to define the research ecology of her practice-based studies<sup>340</sup> aligns with my second defining principle, A Perceptual Ecology (Section 3.3, p. 93). Similarly, Reeve's lenses of pattern and emergence correspond with my principles of Ecological Pattern and Unconventional Affordances (Section 3.3, p. 93), which all provide evidence of new knowledge and expanded understanding of systemic interrelation.<sup>341</sup>

Reeve's study follows Ingold's 'an art of inquiry'<sup>342</sup>: using methods of exploratory movement and reflective observation, research participants are invited to pursue attentive exploratory movement practices in a series of participatory case studies. Reeve does not specify the type or quality of movement; rather, each participant's actions derive from their own internal movement patterns in response to their broader perceptual experience. This open-ended approach enables the participants to explore 'unpredictable pathways of connection through the world'.<sup>343</sup>

Reeve observes and records patterns of movement, behaviour and change over time as each participant attends to their moving body in relation to their environment. Unlike Karanika's study (Section 2.4.5, p. 69), Reeve's enquiry integrates reflective analysis from each participant to capture patterns of awareness and 'the experience of the self 'as an intrinsic part of a wider set of systems'.<sup>344</sup> Reeve's findings indicate that the participants' awareness of themselves in a reciprocal interaction with their environment was increased through attentive and repetitive movement practice.

Adopting a research framework based on Gibson's and Ingold's thinking affords Reeve's study 'an attitude of inclusion rather than one of measurement',<sup>345</sup> moving away from analytical understanding and towards an embodied ecological knowing. Pursuing 'a line of correspondence',<sup>346</sup> Reeve's participants grew into knowledge through the attentive observation of their interrelation with the world.<sup>347</sup> This correspondence is the essence of artistic practice,<sup>348</sup> and the knowledge that emerges from this 'art of inquiry' is, according to Ingold, 'tantamount to a process of growth'.<sup>349</sup>

338 Ibid.,

339 In this context, niche is understood as a set of ecological affordances that describe how a perceiver lives and behaves in their environment (Gibson, 1979, p. 128).

340 Reeve, 2008, p. 82.

341 Ibid., p. 82-83.

342 Ingold, *Making*, 2013, pp. 6-8.; Ingold, 'From Science to Art and Back Again', 2018, p.10.

343 Reeve, 2008, pp. 77-78.

344 Reeve, 2008, p. 244.

345 Reeve, 2008, p. 78.

346 Ingold, 2013, p. 1.

347 Ibid., p. 13.

348 Ibid., p. 108.

349 Ibid., p. xi.

#### 2.4.7 Attunement and Unconventional Affordances

Psychologists Rob Withagen and John van der Kamp integrate Gibson's ecological approach with Tim Ingold's concept of correspondence in *An Ecological Approach to Creativity in Making*<sup>350</sup> to develop a conceptual framework for 'a genuine ecological approach to creativity'.<sup>351</sup> In discussing Withagen and van der Kamp's proposition, I draw on the work of artist Roger Ackling to illustrate how the authors' notion of attunement might apply to a practice-based artistic observation of light.

In their journal article Withagen and van der Kamp contend that whilst 'Gibson's overall conceptual framework has received scant attention in the creativity literature',<sup>352</sup> it affords a valuable ecological foundation for artistic enquiry. The authors propose a Gibsonian ecological framework for artistic practice,<sup>353</sup> based on the principles of interrelation, reciprocity and mutuality. Withagen and van der Kamp assert that creativity, and the new knowledge emerging from it, derives directly from the process of making, in which a maker and their materials 'co-respond'.<sup>354</sup> Creativity is not pre-planned; artistic ideas do not 'originate in an isolated brain',<sup>355</sup> but emerge in the unfolding of 'goal-directed and exploratory activities of the maker',<sup>356</sup> in relation with the medium they utilise.<sup>357</sup>

Advocating the 'primacy of exploratory actions'<sup>358</sup> as the foundation of the creative process, Withagen and van der Kamp suggest that creativity itself 'can be conceived of as the discovery and creation of unconventional affordances'.<sup>359</sup> The authors build on the established sociocultural 'concept of canonical affordances':<sup>360</sup> affordances which are 'conventional and normative'.<sup>361</sup> From this foundation they define an unconventional affordance 'as the unconventional use of an object's affordances'.<sup>362</sup> This use of the term is the foundation of my sixth defining principle, Unconventional Affordances (Section 3.3 p. 93).

The ecological concepts of information, attunement, and exploratory behaviour<sup>363</sup> are influential in the discovery of unconventional affordances. Following Gibson's theories

350 Withagen and van der Kamp, 2018.

351 Ibid., p. 5.

352 Ibid.

353 Withagen and van der Kamp's proposition corresponds with John Steer's and Joseph A. Anderson's earlier adaptations of Gibson's paradigm for the analysis and evaluation of completed works of art.

354 Withagen and van der Kamp, 2018, p. 3.

355 Ibid., p. 4.

356 Ibid., p. 5.

357 Ibid., p. 4.; Ingold, 2013, p. 6.

358 Withagen and van der Kamp, 2018, p. 1.

359 Ibid., p. 1.

360 Costall, 2012, p. 85.

361 Ibid.

362 Withagen and van der Kamp, 2018, p. 4.

363 Ibid., p. 1.

of direct perception and information pickup and Ingold's concept of correspondence, Withagen and van der Kamp claim that attunement with an environment determines both the range of information available and the level of creative expertise that the artist develops.<sup>364</sup> Through attunement, attentive observation and correspondence, the artist is able to detect previously unknown informational nuances within their environment.<sup>365</sup> As new information emerges it allows the artist the possibility of affordances that are neither 'conventional' or 'normative'.<sup>366</sup>

In his light-based practice, the artist Roger Ackling relied upon attentive observation and attunement with his chosen materials. Over his forty-year career,<sup>367</sup> Ackling's light-based practice remained unchanged: holding a small glass lens to focus sunlight to a small intense point, he burned patterns of repetitive lines onto the surfaces of collected driftwood and discarded wooden objects. Ackling's artistic practice was derived from an unconventional use of affordances – he positioned himself and his lens as intermediaries in an interaction between the radiant light of sun and the grain of his reclaimed timber. Ackling's artworks (Figure 2.13, 2.14 and 2.15, p. 75 - 76), derived from this attentively repetitive process, reflect a deep attunement to his materials and the systemic patterns they embody. The repetitive scorched lines that cover each wooden surface imply a far-reaching ecological interrelation.

Attunement and correspondence, Withagen and van der Kamp suggest, offer the artist an increasingly rich field of information which enables new discoveries and the perception of previously unnoticed affordances,<sup>368</sup> even when they interact with familiar materials and environments. Ackling's practice, his materials and process, never varied, but his artworks speak of change and provide evidence of an ecological correspondence in which artist, materials and time are intimately bound. Each sunburnt line is a record of the rotating earth moving on its orbit. Each surface carries the attentive process of an artist situated on a south-facing platform in his garden,<sup>369</sup> harnessing the immense power of sunlight through a slowly tilting hand-held magnifying glass.

Attunement, attentive observation and correspondence are experiential forms of knowing that enable perceptual maturation and learning.<sup>370</sup> Roger Ackling's cumulative sunburnt lines record the passing of moments, minutes, hours, days and years of a life spent knowing light. Withagen and van der Kamp concur with Steer and Anderson, concluding that the environmental properties an artist extracts from their perceptual

.....  
364 Ibid., p. 5.

365 Ibid.

366 Costall, 2012, p. 85.

367 'Roger Ackling', Artist profile, *Annely Juda Fine Art* <<http://www.annelyjudafineart.co.uk/artists/roger-ackling>> [accessed 3 February 2019].

368 Withagen and van der Kamp, 2018, p. 4.

369 'Roger Ackling: Brought to Light' (2018), Exhibitions, *Annely Juda Fine Art* <<http://www.annelyjudafineart.co.uk/exhibitions/brought-to-light-roger-ackling>> [accessed 3 February 2019].

370 Gibson, 1979, p. 245.

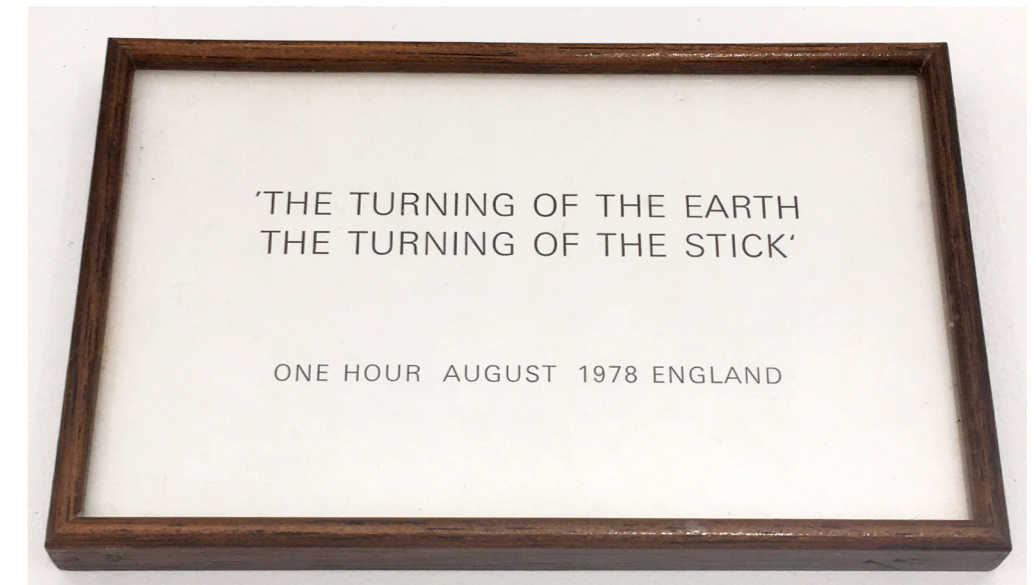

Figure 2.13: 9 *Framed Titles 1978* (1978-1980), Roger Ackling. Photo: Michaela French. Courtesy of Annely Juda Gallery, © The Estate of the Artist.



Figure 2.14: *Weybourne* (1992), Roger Ackling. Photo: Michaela French. Courtesy of Annely Juda Gallery, © The Estate of the Artist.

Figure 2.15: *Voewood (detail)* (2011), Roger Ackling. Photo: Michaela French. Courtesy of Annely Juda Gallery, © The Estate of the Artist.

experience determines the information a finished artwork might offer a viewer.<sup>371</sup> Ackling's quietly compelling artworks afford a timely and 'unconventional' reminder of the value of attentiveness, depth of knowing and cultivation of a 'skilled and sentient correspondence' with the world.

The Gibsonian ecological framework Withagen and van der Kamp propose remains theoretical, but provides a valuable guide for further empirical research.<sup>372</sup> Their interpretation of Gibson's theory contributes the concept of unconventional affordances to my study, and their research confirms my use of attentive observation and attunement as fundamental elements of my Gibsonian research framework.

#### 2.4.8 The Ecological Eye

Attentiveness is a recurring theme in *The Ecological Eye*.<sup>373</sup> A recent publication by art historian Andrew Patrizio that includes Gibson's vision in an expansive exploration of ecological thinking in an art-historical context. *The Ecological Eye*<sup>374</sup> proffers an ecological 'art historical analysis beyond the usual horizon line of disciplinary perspectives',<sup>375</sup> and occupies what Patrizio describes as 'a neglected territory'<sup>376</sup> between the visual arts and an increasing demand for an 'ecocritical'<sup>377</sup> art history. Patrizio frames his socio-political examination of ecology, sustainability and art history within the systemic and reciprocal thinking of ecological psychology and philosophy.

Demonstrating the value of an ecological approach<sup>378</sup> as a response to contemporary socio-political environmental concerns, Patrizio argues that ecological thinking affords a non-hierarchical structure with which to challenge 'dominant, hierarchical discourses'.<sup>379</sup> Patrizio claims that an ecological approach may orient 'us towards a redemptive adjustment',<sup>380</sup> moving beyond the 'sense of nature as instrumental resource'<sup>381</sup> for exploitation.

The scope of Patrizio's ecological examination covers significantly broader socio-political, cultural and critical territory<sup>382</sup> than that which is examined in my research. However, the philosophical, ecological and artistic lineages in this contextual review

.....  
371 Withagen and van der Kamp suggest that observing patterns of behaviour in the creative process may also 'reveal what kind of exploratory movements are required for an (unconventional) affordance to be perceived' (Withagen and van der Kamp, 2018, p. 5).

372 Withagen and van der Kamp, 2018, p. 4.

373 Patrizio, 2019.

374 Ibid.

375 Ibid., p. 2.

376 Ibid., p. 1.

377 Ibid., p. 1.

378 Ibid., p. 31.

379 Ibid., p. 18.

380 Ibid., p. 18.

381 Ibid., p. 16.

382 Including Posthumanism, New Materialism, Ecofeminism, Marxist theory and Queer theory (Patrizio, 2019).

are clearly evident within the terrain Patrizio explores. He traces a history of 'ecological artworks dating from the 1960s to the present'<sup>383</sup> to consider the 'ideological and methodological possibilities'<sup>384</sup> that might be derived from an ecological re-examination of the environmental art movement.

Patrizio addresses a 'complex lateral network of disciplinary concerns',<sup>385</sup> emphasising the interconnectivity between diverse multidisciplinary perspectives, approaches and worldviews, rather than critiquing individual fields of enquiry or examining differences between disciplines.<sup>386</sup> From this position Patrizio assembles an ecocritical art history, revealing a long tradition of ecological scholarship in which 'meaning arises from meeting and connection, from overlapping boundaries'.<sup>387</sup>

Gibson's 'simple but rich'<sup>388</sup> ecological paradigm provides the ontological and metaphorical foundation for Patrizio's concept of the 'ecological eye'.<sup>389</sup> It serves as an 'exemplary expanded ecological vision',<sup>390</sup> offering 'a bridge between environmental aesthetics and art history'.<sup>391</sup> Patrizio argues that Gibson's speculations provide insights that help delineate, articulate and mobilise some of the crucial ethico-perceptual sensibilities needed to effectively synthesise the registers of mind, sociality and environment.<sup>392</sup> In accordance with Gibson's notion of an 'education of attention',<sup>393</sup> the theme of attentiveness<sup>394</sup> emerges throughout *The Ecological Eye*. Patrizio advocates 'a thoughtful practice'<sup>395</sup> which enables the possibility of knowing 'more carefully than single surface readings can allow'.<sup>396</sup> Gibson's ecological vision provides a framework for an attention span that is 'wider and finer and longer and richer and fuller'.<sup>397</sup> However, Patrizio cautions that while attentiveness expands perceptual sensibility, revealing a 'deep interconnectedness that defines ecological conditions wherever they can

383 Ibid., pp. 27, 28.

384 Ibid.

385 Ibid., p. 15.

386 This contextual review can be seen to adopt a similar structure to the model Patrizio employs. The focus of my investigation lies in examining and demonstrating interconnection and inherent relationships between seemingly diverse instances of ecological theory, artistic practice and research.

387 Susan Griffin. 'Ecofeminism and Meaning', in *Ecofeminism: Women, Culture, Nature*, ed. by Karen Warren (Bloomington, IN: Indiana University Press, 1997), pp. 213-26

388 Patrizio, 2019. p. 51.

389 Ibid.

390 Ibid.

391 Ibid.

392 Ibid.

393 Gibson, 1979, p. 254.

394 Patrizio, 2019. pp. 20, 63, 65, 179, 184.

395 Ibid., p. 65.

396 Ibid., p. 65.

397 Ibid., p. 51.

be seen',<sup>398</sup> 'thinking ecologically carries with it a large measure of responsibility',<sup>399</sup> because it demands 'effective responses to matters of concern in our world'.<sup>400</sup>

Patrizio's ecological investigation raises questions that have emerged in my own research regarding the relevance, role and purpose of contemporary artistic practices in the face of increasingly imminent environmental and social reorganisation. Cultivating an ecological perspective, whilst constituting a small individual act, may, through repetition and cumulative effect, be positioned to make a larger societal contribution. Patrizio's work provides my research with a valuable contemporary survey of the critical ecological territory that surrounds my study. Whilst the focus of *The Ecological Eye* remains within an art-historical context, the underlying ecological approach, based on Gibson's vision, corresponds with both the structure and intention of my practice-based investigation. The timely publication of Patrizio's book provided an assurance of the relevance and value of my ecological study.

My brief evaluation of Patrizio's work belies the depth, breadth and complexity of his insightful and revealing survey of the interconnected ecologies that underpin contemporary theories of art, culture, nature and humanity. *The Ecological Eye* affords my research a critical context which imbues the Gibsonian ecological framework I propose with credence and a pertinent sense of currency, purpose and exigency.

#### 2.4.9 The Great Salt Lake

I conclude this section with an ecological detour to the historic artistic site of the Great Salt Lake of Utah, drawing a thematic thread back to my starting point in the 'haptic unconscious'.

In the first paragraph of *The Haptic Unconscious* (Section 2.4.2, p. 53) I discussed a connection between the work of artist Robert Smithson and Gibson's theory. Smithson is known for his environmental sculpture *Spiral Jetty* (1970) (Figure 2.16, p. 80), a 460-metre earthwork constructed on the north-eastern shore of the Great Salt Lake which was recently integrated into a new site-specific commission.

*Great Salt Lake and Vicinity* (2017) (Figure 2.17, p. 80, 2.18 and 2.19, p. 81) was artist Spencer Finch's response to the light and colour of the Great Salt Lake environment. Finch's artistic practice centres on subjective observations of light recorded in specific spatial and temporal locations.<sup>401</sup> In his *Great Salt Lake and Vicinity* installation, a series of Pantone colour swatches affords evidence of Finch's three-day circumnavigation of

398 Ibid., p. 179.

399 Ibid., p. 65.

400 Ibid., p. 180.

401 Finch records his colour samples using a chromometer, a device that translates light into readings of colour temperature, to create his ultimately poetic investigations of personally and culturally significant locales (Feldman, 2015, p. 32.).



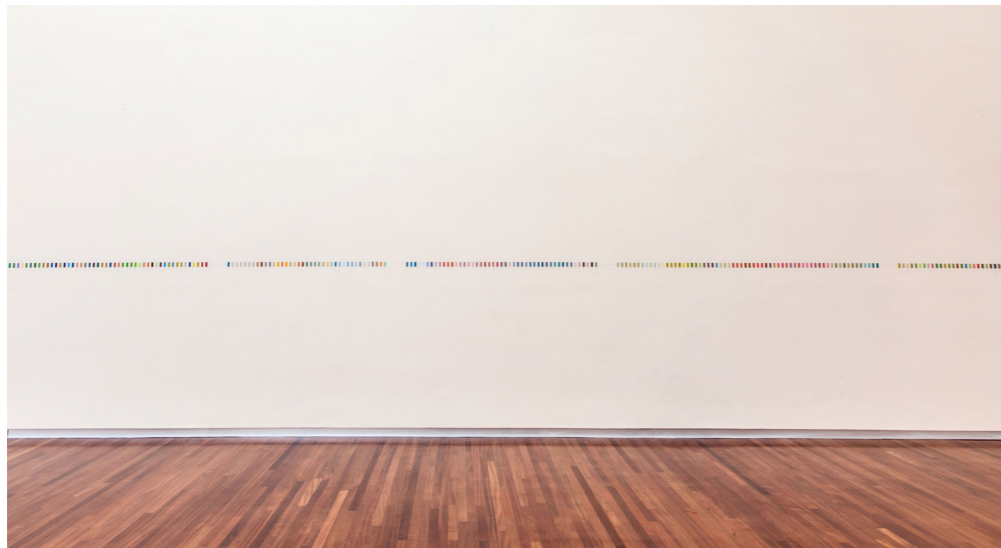

Figure 2.16: *Spiral Jetty* (1970), Robert Smithson. Photo: Gianfranco Gorgoni.

Figure 2.17: *Great Salt Lake and Vicinity* (2017) Spencer Finch, paper, pencil, Pantone color system, site specific installation. All images from the permanent collection at the UMFA, University of Utah, Salt Lake City. Purchased with funds from The Phyllis Cannon Wattis Endowment Fund.

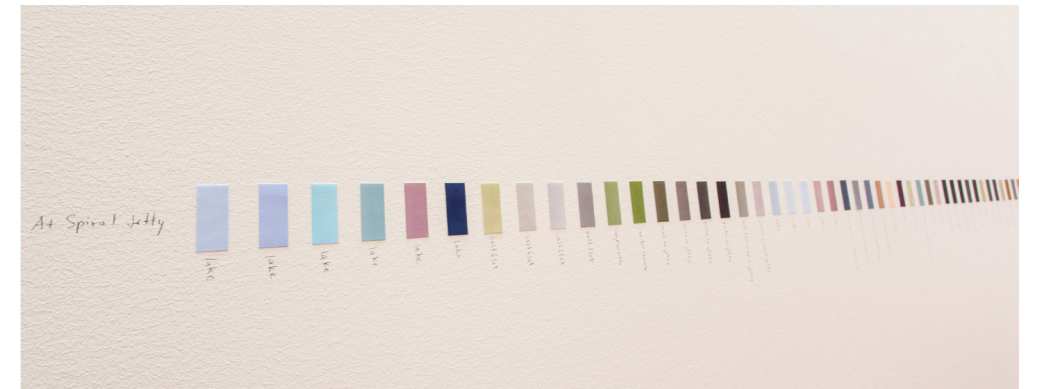
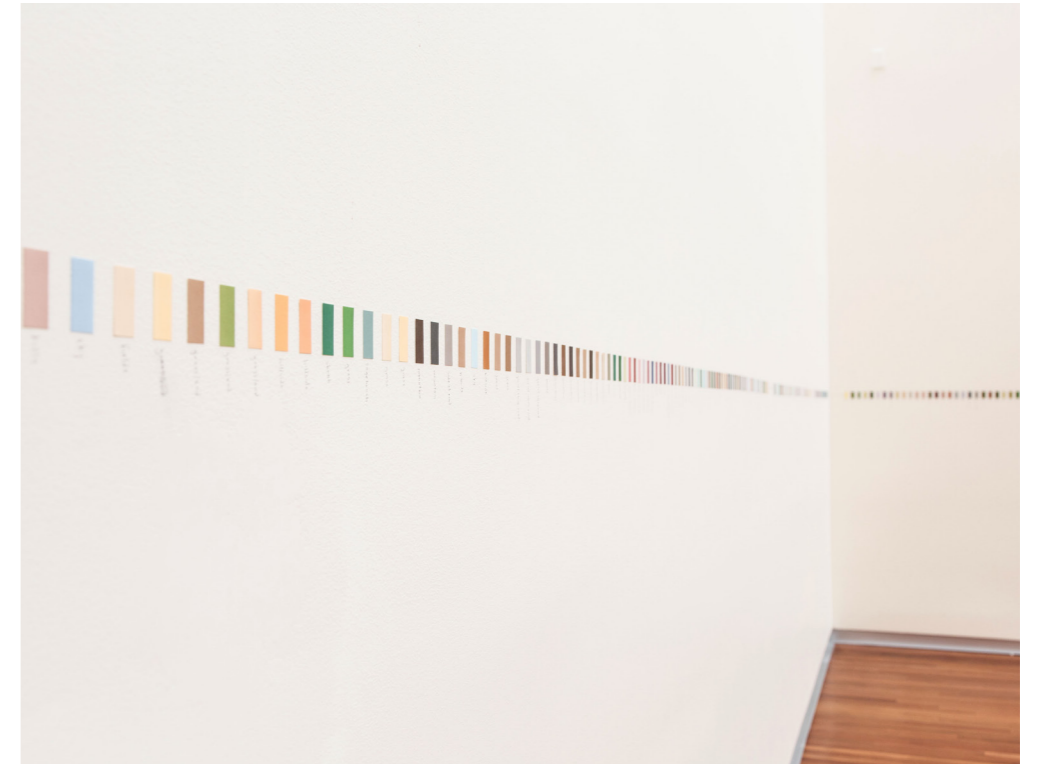

Figure 2.18: *Great Salt Lake and Vicinity* (2017) Spencer Finch, paper, pencil, Pantone color system, site specific installation.

Figure 2.19: *Great Salt Lake and Vicinity* (2017) Spencer Finch, (detail: *Spiral Jetty*), paper, pencil, Pantone color system, site specific installation. From the permanent collection at the UMFA University of Utah, Salt Lake City.

Utah's Great Salt Lake.<sup>402</sup> Finch's 'line of color reads like field notes'<sup>403</sup> (Figure 2.17, p. 80 and 2.18, p. 81) and incorporates a sequence that records the light and colour of Smithson's *Spiral Jetty* at the time of Finch's observation (Figure 2.19, p. 81).

*Great Salt Lake and Vicinity* is 'a data-driven abstraction of close observation',<sup>404</sup> a representational narrative which records a journey through place, time and light. On one hand, Finch's work is a simple record of an individual artistic observation of light; on the other it speaks of interrelation, connection, and overlapping boundaries. Like my own artistic investigation, Finch's artwork corresponds with Gibson's ecological vision of light, and echoes the entwined patterns of interrelation of light, art, environment, history and the human sensorium that binds the 'haptic unconscious'<sup>405</sup> to the ecocritical assemblage of Patrizio's *The Ecological Eye*.

The ecological territory traversed in this discussion defines the critical context for my practice-based artistic research, and, as I will show in the following section, it also contributes to the theoretical, philosophical and artistic foundation of Information Experience Design.

## 2.5 Information Experience Design

The critical lineage of the Information Experience Design (IED) programme of study can be traced, in part, through the same syncretic trajectories I have explicated following the line of Gibson's ecological influence through art and design. In this section, I discuss the characteristics of IED thinking that correlate with this ecological terrain and with my own artistic research.

With its conceptual roots in the transdisciplinary thinking and exploratory art and design practices of the 1960s and '70s, IED can be considered a contemporary iteration of the 'haptic unconscious',<sup>406</sup> integrating, expanding and re-imagining the systems thinking of cybernetics; the artistic, technological and social connectivity of 'systems esthetics'<sup>407</sup>; the experimental light-based systems art movements inspired by Kepes, Burnham and E.A.T., and the information systems of the Bell Laboratories. The trajectories that carried Gibson's theories into contemporary discourse provide the critical ground for the IED programme and reflect a shared (if temporally divided) desire to move beyond outmoded ways of thinking. By situating my research in IED my investigation is anchored in this historical ecological lineage. This validates my choice to position this study in the IED programme over a more conventional artistic discipline.

Lead proponent Kevin Walker states that IED builds on this historical foundation

.....

402 There are clear points of intersection between Finch's artwork and my *Daylight Observations* artistic research project I present in Chapter Five (pp. 123-142). My study was completed prior to Finch's commission, and therefore any similarity is coincidental.

403 Tassie, Whitney, in Claire Voon, 'A Pastel Portrait of Spiral Jetty and Its Environs', *Hyperallergic* (23 November 2017) <<https://hyperallergic.com/398186/a-pastel-portrait-of-spiral-jetty-and-its-environs/>> [accessed 27 August 2019].

404 Ibid.

405 Terranova, 2013.

406 Terranova, 2013.

407 Jones, 2012.

by applying a post-disciplinary systems approach to contemporary art and design practice and research. IED engages 'directly with technologies as a critical practice',<sup>408</sup> It deconstructs Norman's and Gaver's adaptation of Gibson's affordances in design to re-emphasise an experiential approach in experience design;<sup>409</sup> and by rejecting disciplinary distinctions, it questions, de-constructs and subverts accepted models of investigation and design practice<sup>410</sup> to 'initiate renewed thinking and innovation in the context of critical practice'.<sup>411</sup> IED's critical methodological approach cross-pollinates research methods from contemporary art, design, journalism and the social and physical sciences. IED's socio-political perspectives correspond with the synthesis of 'mind, sociality and environment'<sup>412</sup> that Patrizio navigates in assembling his ecocritical territory in contemporary art history.

New knowledge emerges in IED through the direct experience, emphasising innovation in exploratory action rather than in the construction of abstracted theoretical models. IED dismisses distinctions between research and practice,<sup>413</sup> considering the practitioner-researcher to be integral to and entwined with the systems they study. The multi-sensory art and design processes that define the IED programme are derived from deep subject-specific practice-based investigations<sup>414</sup> that employ experiential methods for data collection and analysis. IED frames its contribution to knowledge in terms of methodological innovation<sup>415</sup> based on the interrelation between 'language and action, information and experience; and between disparate fields of study'.<sup>416</sup>

IED can be considered a collective plurality, which assembles 'highly diverging processes that often trespass the categories of boundaries'.<sup>417</sup> Grounded in the non-linear logic of 'both/and' reasoning,<sup>418</sup> IED cultivates an expansive view art and design research which 'is undertaken by nature as well as humans [...] with a commensurate emphasis on systems and relations'.<sup>419</sup> IED's socially engaged, experiential, post-disciplinary approach requires the IED practitioner-researcher to be multidisciplinary and able to traverse a diverse range of 'sources in several fields'.<sup>420</sup>

.....

408 Walker, 'A Systems Approach to Design Innovation', 2018.

409 Kevin Walker, 'Experience beyond Humans', in Proceedings of ACM Woodstock Conference presented at the Woodstock '18 (New York, NY: ACM, 2018).

410 Kevin Walker, 'Investigative Design: Materiality, Systems, Critique' presented at Beyond Change: Questioning the Role of Design in Times of Global Transformations (Basel, Switzerland: Swiss Design Network Research Summit, 2018) <<http://www.beyondchange.ch/front>>.

411 Walker, 'A Systems Approach to Design Innovation', 2018, p.5.

412 Patrizio, 2019, p. 52.

413 Ibid., p. 5.

414 Ibid., p. 4.

415 Ibid.

416 Ibid., p. 9.

417 Klein, 2017.

418 Jenkins, 2008.

419 Walker, 'Investigative Design: Materiality, Systems, Critique' 2018, p. 8.

420 Nelson, Robin, *Practice as Research in the Arts* (London: Palgrave Macmillan, 2013), p. 34.

Whilst this approach reflects a clear leaning towards an ecological stance, the IED research repertoire does not currently extend to an ecological methodological approach for practice-based artistic research.<sup>421</sup> This provides an opportunity for my investigation to contribute to the IED programme of study by expanding scholarship into unexplored ecological territory.

## 2.6 Identifying a Gap in Knowledge

In this contextual review I have evidenced the influence of Gibson's ecological paradigm across numerous theoretical and practice-based fields of enquiry in the arts. Since its publication in 1979, Gibson's ecological approach to visual perception has offered artists and theorists a foundation for examining the interrelation between light and perceiver, for articulating the ecology of perceptual experience, and for examining systemic interrelation and mutuality. As I have shown, Gibson's theory has been examined and applied by a select group of theorists, art historians and practitioner-researchers who each advocate the value of his ecological vision as a foundation for practical and analytical enquiry in the arts. Despite this ongoing influence the potential of Gibson's ecological paradigm as a conceptual framework for practice-based artistic research is yet to be fully investigated. This gap in knowledge affords an opportunity for my research to make an original contribution to this 'community of inquiry'<sup>422</sup> which I refer to as 'ecological artistic scholarship'.

My research addresses this gap in knowledge by developing the Gibsonian methodology and framework for ecological artistic research that I describe in detail in Chapter Three (pp. 89-102). In developing this Gibsonian approach for my own practice-based research enquiry, I have extracted, adapted, translated and applied Gibson's principles to devise and articulate an ecological framework for artistic research which is transferable and adaptable for other practitioners, particularly those interested in light, to undertake critical research within an ecological context. The Gibsonian framework I propose in my study has been tested through the four practice-based artistic research projects I describe in Chapters Four to Seven (pp. 103-180). In addition, this Gibsonian ecological methodology and framework I develop in this study serves as a bridge between the IED discourse and the broader network of ecological artistic scholarship that I have identified in this chapter.

My investigation, based on Gibson's ecological vision, may also contribute to artistic research more broadly by responding to a growing call for practice-based research approaches that operate across and beyond traditional disciplinary boundaries.<sup>423</sup> Artist and theorist Annette Arlander posits that artistic research can offer 'the possibility of

.....  
421 Gibson's *The Theory of Affordances* (1979) has been a core text in the IED programme reading list since the department began at the Royal College of Art in 2014. In my first year as a PhD candidate I was invited to present a seminar about on Gibson's affordances. At the time I knew little of his broader ecological theory, and in preparing this lecture I came across the line 'Radiant light is energy; ambient light can be information' (Ibid., p. 50). This text was pivotal and served as the starting point for my Gibsonian investigation of light. I have delivered a seminar about Gibson's ecological approach to visual perception every year, and each year Gibson's theory has afforded me new discoveries and new ways of seeing.

422 Buchanan, 2001 p. 23.

423 Mackay, 2016.; Arlander, 2016.; Klein, 2017.

a meeting ground',<sup>424</sup> a site in which unexpected clashes and combinations<sup>425</sup> create 'new possibilities for understanding'.<sup>426</sup> Whilst traditionally the variety and diversity of contemporary artistic research was seen as a weakness; the capacity to combine interdisciplinary approaches, phenomena and concepts is now seen as one of its strengths.<sup>427</sup> An artistic practitioner-researcher does not seek to 'equal the specialist in all disciplines drawn upon',<sup>428</sup> as the value of artistic research lies 'in syncretism, not in depth-mining'.<sup>429</sup> The increasing emergence of inter-/multi-/trans-<sup>430</sup> and post-disciplinary approaches in artistic research does not inherently indicate a 'demise of disciplinarity';<sup>431</sup> rather, the expansive and divergent thinking and practices of post-disciplinary artistic research complement 'ever-narrowing disciplinary expertise'.<sup>432</sup> Each mode of enquiry integrates and generates different types of knowledge: when combined, these multiple approaches afford what Gibson would describe as information-rich outcomes.

Arlander asserts that artistic research as a multi- and inter-disciplinary meeting place should move toward socially engaged practices which challenge the traditional role of the artist.<sup>433</sup> This site, she argues, is needed now more than ever.<sup>434</sup> Arlander is not alone in her call for expanded approaches in artistic research.<sup>435</sup> Ingold's appeal for a renewed process of 'radical ecological awareness' is a call to arms for contemporary art<sup>436</sup> which Patrizio echoes, arguing that the demand for artists and art theorists to respond to real-world issues is increasingly pressing.<sup>437</sup> In establishing a Gibsonian framework for ecological artistic research my investigation is positioned to contribute to the ecological imperatives that increasingly inform contemporary artistic and cultural discourse.

.....

424 Arlander, 2016, p. 3.

425 Ibid., p. 4.

426 Ibid.

427 Arlander, 2016, p. 4

428 Nelson, 2013, p. 34.

429 Ibid.; The syncretic approach Nelson speaks of here is reflected in my research and in the influence of Gibson's ecological approach within the arts, as I have presented in this contextual review.

430 Arlander, 2016, p. 3.

431 Robert Frodeman, *Sustainable Knowledge - A Theory of Interdisciplinarity* (Basingstoke: Publisher Palgrave Macmillan, 2014) p. 2.

432 Arlander, 2016, p. 3.

433 Ibid., p.5

434 Ibid., p.3

435 Klein, 2017; Mackay, 2016; Elpida Rikou and Eleana Yalouri, 'The Art of Research Practices Between Art and Anthropology', *Field Journal*, 11, (2018) <<http://field-journal.com/editorial/introduction-the-art-of-research-practices-between-art-and-anthropology>> [accessed 19 February 2019]; Paul Rodgers and Craig Bremner, 'Alterplarity - "Alternative Disciplinarity" in Future Art and Design Research Pursuits', *Studies in Material Thinking*, 6 (2011) <<https://www.materialthinking.org/papers/64>> [accessed 11 December 2018].

436 Ingold, 'Search and Search Again' 2018, 57:30.

437 Patrizio, 2019, p. 180.

## 2.7 A Contextual Summary

In this contextual review I have established the critical, conceptual and artistic ecological terrain that underpins my investigation. Following the trail of Gibson's legacy through the arts I examined a diverse range of literature, artistic practices, analysis and histories to situate my research in an established ecological artistic tradition. Beginning with Gibson's origins in Kurt Lewin's ecological psychology, I examined Gibson's ecological thinking through selected examples of contemporary art and design theory and practice culminating in the ecocritical art history of Patrizio's Ecological Eye and the post-disciplinary research practices of Information Experience Design. This chapter illustrates the persistence and relevance of Gibson's ecological thinking in the arts, it defines the contextual foundation of my study, and it offers evidence in response to my two research questions:

1. Which principles and concepts from Gibson's ecological approach to visual perception might be adapted and applied to frame ecological artistic research that facilitates an education of attention through the rigorous observation of light?
2. What practice-based methods emerging from a Gibsonian research framework might be applied through artistic practice to cultivate an ecological worldview?

In answering my first research question, this contextual review provides examples of how Gibson's ecological theory might be applied as a framework for artistic enquiry, and provides insights into which Gibsonian principles might best contribute to practice-based artistic research. With the exception of Norman's and Gaver's affordances, all of the adaptations discussed in this review were premised on Gibson's ecological concepts of direct perception, mutuality and information pickup which I outlined in Sections 2.2 & 2.3 (pp. 43 - 52).

In this contextual review, Gibson's ecological approach has been adapted for artistic enquiry in the following ways, as a:

- > theoretical framework for analysing creativity and artistic experience
- > conceptual foundation for practice-based artistic research and enquiry
- > foundation for ecocritical theoretical investigation

I address each of these points in turn. Steer, Anderson and Withagen and van der Kamp each adapt Gibson's approach as a theoretical framework for ecological analysis of visual art, the cinematic experience and the process of creativity, respectively. Whilst their individual approaches vary, they all conclude that Gibson's concept of invariants serves as the primary means by which an artist selects information from the total spectrum of experience<sup>438</sup> in the process of creating an artwork. Steer, Anderson

.....  
438 Steer, 1989, p. 98.

and Withagen and van der Kamp also concur that the information the artist selects subsequently determines the affordances available to the viewer in experiencing an artwork, and suggest that exploratory action<sup>439</sup> is fundamental in the creative process both for the artist and the viewer. The adaptations of Gibson's paradigm these theorists have applied provide evidence of the viability of Gibson's paradigm as a framework for ecological artistic enquiry, and align with the Gibsonian framework I propose in this study (Section 3.4, p. 95). In particular, the concepts of invariants, affordances, and, in the case of Withagen and van der Kamp, unconventional affordances, are identified as effective in elucidating the artistic experience. This corresponds with the defining principles of Ecological Pattern and Unconventional Affordances (Section 3.3, p. 93).

In applying Gibson's ecological paradigm as a conceptual foundation for practice-based artistic research, Reeve, Sjölin and Karanika each adopted a Gibsonian approach in order to contextualise and analyse specific aspects of perceptual experience in their practice-based PhD studies. Reeve's movement studies relied upon mutuality and co-perception of the self and the environment; Sjölin's sound installations were premised on affordances, and Karanika's interactive artistic investigation was based on a unified perceptual system. All three researchers concluded that attentional focus and active exploration were critical in generating new knowledge. These three practice-based studies show that Gibson's theory can provide an effective research structure for ecological artistic research undertaken through direct perceptual experience. However, none of these investigations articulate a transferable Gibsonian ecological framework, thereby providing an opportunity for my research to contribute to ecological artistic scholarship.

Unlike the examples discussed above, Patrizio's use of Gibson's theory as a foundation for ecocritical theoretical investigation does not offer a framework for ecological artistic research; however, Patrizio's and Ingold's use of Gibson's vision to bridge a range of disciplinary ecologies demonstrates the broader value of an ecological perspective in art and design discourse. The concept of attentiveness emerges as a recurrent theme in both Patrizio's and Ingold's ecological investigations, and corresponds with my epistemological foundation in Gibson's notion of 'an education of attention'<sup>440</sup>

Woven into the ecological terrain of this contextual review are a series of artworks and artistic practices based on the perception and observation of light. In response to my second research question, the methods of observing, mediating, focusing and structuring light these artists employ in their practice confirms that the methods (Section 3.5, p. 97) I propose in my Gibsonian framework are well suited to artistic research based on the observation of light. From Turrell's immersive interactions with the ambient optic array to Barth's light-filled frames, Eliasson's studies of visual perception and the attentive observations of Ackling and Finch, each artwork and artistic process articulates the perceptual experiences Gibson describes in his ecological theory. These artists use light as 'a kind of perceptual ground zero'<sup>441</sup> to sensitise themselves and the

.....  
439 Withagen and van der Kamp, 2018, p. 1.

440 Gibson, 1979, p. 254.

441 Feldman, 2015, p.28.

viewer to their 'own perceptual processes and the mechanisms of attention'.<sup>442</sup> Light serves as a catalyst to reveal the underlying ecological interrelation this investigation examines. The artistic and analytical adaptations of Gibson's theory presented in this chapter offer evidence of the viability and value of a Gibsonian framework for ecological artistic research.

The Gibsonian methodological approach and framework for ecological artistic research I propose affords a new kind of artistic research which has the potential to expand the IED research repertoire, to contribute to the emerging territory of ecological artistic research, and to offer a response to the growing demand for artistic research approaches that advocate an ecological worldview. Having defined the ecological territory in which my research resides, in the following chapter I provide a detailed account of the Gibsonian methodological approach and research framework I develop in this study.

## Chapter Three

# An Ecological Methodology

.....  
442 Ibid.

### 3.1 Introduction

In this chapter I define a methodological approach for practice-based artistic research based on Gibson's ecological vision. To begin, I specify the key concepts and principles I draw out of Gibson's theory that govern the epistemological, theoretical, and methodological structures of my ecological research framework. I then illustrate how this Gibsonian methodological approach translates to a practice-based artistic enquiry. From this position, I define the three practice-based research methods I use to facilitate an education of attention through the attentive observation of light and I specify the evaluation criteria I employ in this study.

### 3.2 A Gibsonian Framework for Ecological Artistic Research

The epistemological foundation of my research resides in Gibson's concept of an 'education of attention'.<sup>443</sup> Gibson proposes that 'with practice and the education of attention'<sup>444</sup> it is possible to improve and expand the capacity and awareness of the perceptual system. By educating attention through attunement, refinement and intentional interaction with the world, the perceptual system becomes sensitised; differences previously unnoticed become apparent, and formerly vague features become distinctive.<sup>445</sup> The potential to develop perceptual awareness by educating attention is limited only by a perceiver's capacity and motivation to acquire knowledge.<sup>446</sup> An education of attention is the cornerstone of this research. In response to my first research question:

1. Which principles and concepts from Gibson's ecological approach to visual perception might be adapted and applied to frame ecological artistic research that facilitates an education of attention through the rigorous observation of light?

I extract the following core concepts from Gibson's theory and adapt them into a set of six methodological principles:

- 01: Light as Information (Ecological Information)
- 02: A Perceptual Ecology (Ecological Knowing)
- 03: Attentive Observation
- 04: Ecological Pattern
- 05: A New Level of Description
- 06: Unconventional Affordances

.....

443 Gibson, 1979, p. 254.

444 Ibid.

445 Ibid.

446 Ibid., p. 57.

These principles are the underpinning of Gibson's ecological theory, and form the conceptual foundation of this research. They define the structure of my artistic research projects and are pivotal to the analytical and practical research methods employed in this study. Table 3.1 (below) provides an overview of the Gibsonian Framework for Ecological Artistic Research I develop in this study.

A Gibsonian Framework for Ecological Artistic Research	
Research Framework	Gibsonian Principles
Epistemology	An Education of Attention
Theoretical Perspective	Gibson's Ecological Approach to Visual Perception
Methodological Principles	Ecological Artistic Research  01: Light as Information (Ecological Information) 02: A Perceptual Ecology (Ecological Knowing) 03: Attentive Observation 04: Ecological Pattern 05: A New Level of Description 06: Unconventional Affordances
Research Methods	Durational Observation  Ecological Lenses  Reflective Artistic Practice
Evaluation Criteria	Attunement to Light  Emergent Patterns  Unconventional Affordances

Table 3.1: The Gibsonian Framework for Ecological Artistic Research (2019), Michaela French.

### 3.3 Six Defining Methodological Principles

In this section I offer a description of the six Gibsonian methodological principles that define the framework for ecological artistic research.

#### 01. Light as Information (Ecological Information)

Gibson proposed that light not only provides information about an environment, but can also itself be information.<sup>447</sup> This proposition diverged from conventional scientific thinking by suggesting the variable structures of light in the ambient optic array 'constitute information for an active perceiver'.<sup>448</sup> In the context of ecological visual perception Gibson proposed that in a uniform field of ambient light information equates to difference, stating that 'the light at the point of observation has to be different in different directions in order for it to contain any information'.<sup>449</sup> Difference, variation and change in the light of the ambient optic array constitutes the primary source of data in my research enquiry.

#### 02. A Perceptual Ecology (Ecological Knowing)

Gibson situates a perceiver, the process of perception, the co-perceiving of the self, and the environment within an inseparable, dynamic interaction of information exchange. This exchange takes place within a reciprocal ecology where 'the persistence of the environment together with the coexistence of its parts and the concurrence of its events are all perceived together'.<sup>450</sup> The structured light of the ambient optic array is implicit in this ecology, acting as an agent for vision whilst simultaneously shaping the information available for perception.<sup>451</sup> Gibson contends that in this ecological context, knowing is 'an *extension of perceiving*'.<sup>452</sup> and argues that direct perception is 'the simplest and best kind of knowing'.<sup>453</sup> In a perceptual ecology knowledge is derived through the presence and actions of a perceiver in their environment. Equally, 'perceivers are what they are owing to the support of action by the environment'.<sup>454</sup> In this research, this reciprocal perceptual ecology is defined as the light-perceiver-environment nexus.

#### 03. Attentive Observation

A perceiver's perceptual system is 'susceptible to maturation and learning',<sup>455</sup> and can be educated through attunement, refinement and intentional interaction in the world.

447 Gibson, 1979, p. 51; Braund, 2008, p.132.

448 Braund, 2008, p.134.

449 Gibson, 1979, p. 51.

450 Gibson, 1979, p. 222.

451 Ibid., p. 66, 164.

452 Ibid.,p. 258 (emphasis in original).

453 Ibid., p. 263.

454 Zahoric and Jenison, 1998, p. 87.

455 Gibson, 1979, p. 245.

When attuned or sensitised to different types of information, the 'state of a perceptual system is altered'.<sup>456</sup> The process of attentive observation facilitates perceptual learning. The purpose, intent and action of the perceiver<sup>457</sup> within this process impacts on the quality, variety and amount of information available to them. New knowledge emerges from changing how we perceive, rather than by changing what we know. In an ecological context, it is through attentive observation that a perceiver grows into knowledge<sup>458</sup> as the capacity of the perceptual system expands. Ecological reciprocity ensures that as perception develops, knowledge of the world increases, and a perceiver is able to cultivate a new conception and experience of their environment.

#### 04. Ecological Pattern

Dynamic ecological interactions observed at an individual level can provide insight into the systemic relationships inherent across different environmental scales.<sup>459</sup> In the context of visual perception, the structured patterns of light in Gibson's ambient optic array specify an environment at a particular moment in time. However, observed repeatedly over longer periods of time, emergent patterns of information reveal higher level structures and repetitions across multiple scales within a perceptual ecology. Ecological patterns may be evident in variations in environmental, relational and perceptual information. These patterns invite critical reflection and ecological analysis by providing perspectives that enable 'the making of statements about ecological systems from within the system itself'.<sup>460</sup>

#### 05. A New Level of Description

Gibson's ecological approach to visual perception attempted 'a new level of description'.<sup>461</sup> He offered a series of exploratory proposals premised on the idea that the 'construction of a theory is most valuable when the theory is 'vulnerable', when future experiments can, but do not, disprove it'.<sup>462</sup> Gibson's open-ended approach issued an invitation 'to unlearn',<sup>463</sup> and was deliberately designed to incite renewed analysis within his field.<sup>464</sup> In the context of this study, a new level of description can be framed as conceptual, experiential or physical, taking the form of expanded perceptual awareness, new modes of questioning, emergent patterns or unconventional affordances, new artworks, a revitalised perspective and an expanded ecological

.....  
456 Ibid.

457 Heft, 2001, p. 213.

458 Ingold, *Making*, 2013, p.13.

459 Grandy, 2009, p. 52.

460 Peter Harries-Jones, 2008, p. 162.

461 Gibson, 1979, p. xii.

462 James J. Gibson, in E. H. Gombrich, 'Distinguished Dissident: Review of James J. Gibson and the Psychology of Perception by Edward S. Reed', *New York Review of Books*, (January 1989), 13-15 (p.13), (emphasis in original).

463 Gombrich, 1989, p. 2.

464 Ibid.

worldview. A new level of description affords a point of culmination, marking the end of a research cycle and simultaneously acting as a provocation that invites subsequent investigation.

#### 06. Unconventional Affordances

Following the description in Section vi (p. 26) Gibson's concept of affordances refers to what an environment 'offers the animal, what it provides or furnishes'.<sup>465</sup> The relational possibilities of affordances are limited only by the perceptual capacity and action of a perceiver. As a perceptual system evolves, matures and learns,<sup>466</sup> the affordances perceived are also altered as the available information becomes more elaborate. As perceptual capacity is expanded through attentive observation and exploratory engagement in the world, information is refined, new ecological patterns become apparent and 'unconventional affordances' emerge. An unconventional affordance diverges from established action possibilities by inviting novel ways of perceiving, understanding and responding to the world. This is the new knowledge an artist-researcher strives for in a practice-based artistic research enquiry.

These six methodological principles form the foundation of my practice-based and theoretical research. In the following sections I describe how these six principles are adapted and applied as a framework for practice-based enquiry.

### 3.4 An Action Model for Ecological Artistic Research

From this theoretical foundation, the first five of these six methodological principles are translated to practice using Kurt Lewin's Action Research model<sup>467</sup> to define the progressive research stages for my practice-based ecological artistic enquiry. In this context, I integrate Lewin's Action Research model<sup>468</sup> as part of my methodological framework, following Swann's definition of action research as a methodology<sup>469</sup> which through the use of appropriate methods and techniques 'is intended to have both action outcomes and research outcomes'.<sup>470</sup> The sixth Gibsonian principle, Unconventional Affordances, is not applied as a stage in the action research process. Rather,

.....  
465 Gibson, 1979, p. 127.

466 Ibid., p. 245.

467 Kurt Lewin 'Action Research Cycle', in '*Action Research in Retrospect and Prospect*', Stephen Kemmis, presented at the Annual Meeting of the Australian Association for Research in Education, (Melbourne, Australia, November 1980) <<https://eric.ed.gov/?id=ED200560>> [accessed 2 November 2019].

468 Whilst more recent action research models are available, I have chosen to return to Kurt Lewin's original version for two reasons: first, the emphasis in Lewin's original model was conceptual and observational. Lewin applied action research to observe and understand systems and patterns of interrelation rather than adopting the problem-solving focus of recent interpretations; second, as I established in Section 2.3.3 (p. 47) Gibson's paradigm is strongly influenced by Lewin's ecological thinking and as such there is a certain symmetry in combining and applying these two ecological models in their original form.

469 Cal Swann, 'Action Research and the Practice of Design', *Design Issues*, 18.1 (2002), 49-61. <<https://doi.org/10.1162/07479360252756287>>.

470 Bob Dick in Cal Swann, 'Action Research and the Practice of Design', *Design Issues*, 18.1 (2002), 49-61, (p. 56). <<https://doi.org/10.1162/07479360252756287>>.



Unconventional Affordances are research outcomes in this study, offering evidence of new knowledge and an education of attention. Unconventional Affordances serve as one of the evaluation criteria in this research, as specified in Section 3.6 (p. 99). Table 3.2 (below) illustrates how the first five methodological principles are mapped to the stages of Lewin's Action Research model (Figure 2.1, p. 46). This adaptation of Gibson's approach into a model for ecological artistic research provides the structure for my practice-based research process and specifies the conceptual foundation for each stage of my artistic research process.

An Action Research Model for Ecological Artistic Research		
Gibsonian Ecological Principles	Kurt Lewin's Action Research Cycle	Ecological Artistic Research Action Stages
Light as Information (Ecological Information)	Conceptualisation	Specify light information for observation and collection.
A Perceptual Ecology (Ecological Knowing)	Planning	Define scope of study: criteria and process for data collection and evaluation.
Attentive Observation	Execution	Data collection.
Ecological Pattern	Evaluation	Reflective Artistic Practice: data analysis, making, and meaning creation.
A New Level of Description	Reconceptualisation	Final analysis, evaluation and reconceptualised research ecology. Commence new research cycle.

Table 3.2: Adapting Gibsonian Principles to a Framework for Ecological Artistic Research (2019), Michaela French.

### 3.5 Research Methods

The Gibsonian framework for ecological artistic research enables me to test Gibson's theory through a series of four artistic research projects: *A Year of Light* (2015), *The Old Lookout* (2015), *Daylight Observations* (2016) and *Earth Below Me Sky Above* (2017) (Chapter Four to Seven, pp. 103-180). I employ three practice-based research methods in each of these projects: Durational Observation, Ecological Lens and Reflective Artistic Practice. These research methods are governed by the Gibsonian ecological methodology and have been developed in response to my second research question to facilitate 'an education of attention'<sup>471</sup> through rigorous observation of light with the intention of cultivating an ecological worldview.

The three research methods I describe below are rigorous, repeatable and capable of generating reliable data through practice-based artistic research. Each method affords specific modes of questioning and enquiry to enable an examination of the research questions from multiple concurrent perspectives. The artworks produced using these research methods provide a body of evidence to support my Gibsonian framework for artistic research as an original contribution to knowledge. Each of these three methods, or versions thereof, are applied in all four of the artistic research projects I present in Chapters Four to Seven (pp. 103-180).

#### Durational Observation

Durational Observation uses attentive observation to study and record fluctuations and variations in light over extended periods of time.<sup>472</sup> The recorded variables are physically observable properties of light, including the light source, luminance, hue and quality of light from a specified time and location. In addition, the interaction between light and matter and the perceptual experience of the artist-researcher are observed with this method. Durational Observation takes place within Gibson's ambient optic array and is governed by his concepts of direct perception, mutuality and ecological reciprocity. The Durational Observation method generates visual data sets of comparative light samples through a rigorous research process using digital photography, digital light sensors, subjective observation and digital colour swatches to record data. Durational Observation is the primary data collection method used in my artistic research projects.

#### Ecological Lens

The Ecological Lens research method was developed specifically for this study. It is a form of thought experiment used to provoke renewed examination of the ecological interrelation between light and perceiver. Ecological Lens invites the artist-researcher to examine their perceptual experience by offering a specifically focused ecological

<sup>471</sup> Gibson, 1979, p. 254.

<sup>472</sup> Durational Observation is a form of field study, based on longitudinal research, designed to observe change over time. The temporal aspect of durational observation studies is critical, as it enables prolonged engagement with the subject and generates data which is not available through other methods of investigation. (Elisabetta Ruspini, *An Introduction to Longitudinal Research* (London: Routledge, 2003)).

idea, concept or intent. Ecological Lenses are applied within the durational observation process to re-frame, re-focus and expand perceptual awareness within a practice-based enquiry. The Ecological Lens method does not produce data directly, but operates as a provocation to disrupt established patterns of perception and thinking.

The Ecological Lens method facilitates new ways of looking at the light-perceiver-environment nexus. When effective, Ecological Lenses influence data sets, artworks and ecological thinking emerging from the artistic research projects. The Ecological Lens method addresses the research questions by examining and testing strategies for expanding the artist-researcher's perceptual awareness through attentive observation to cultivate an ecological worldview. Table 3.3 (below) specifies the Ecological Lens applied within each of the four artistic research projects.

Ecological Lenses in each Artistic Research Project		
Project Title	Ecological Lens	Gibsonian Principles
A Year of Light (2015)	The Membrane is Permeable	Light as Information Attentive Observation
The Old Lookout (2015)	There is No Membrane	A Perceptual Ecology Ecological Pattern
Daylight Observations (2016)	Three Black Squares	Unconventional Affordances
Earth Below Me Sky Above (2017)	States of Becoming	Ecological Pattern A New Level of Description

Table 3.3: The Ecological Lenses applied in each Artistic Research Project (2019), Michaela French.

### Reflective Artistic Practice

This method facilitates a practice-based investigation in which research is 'integral to the processes of thinking, making, and reflecting'<sup>473</sup> that constitute artistic production and enquiry. The light samples and data sets recorded in the durational observation process provide the raw materials to produce artworks derived from a 'reflective conversation with the materials of a situation'.<sup>474</sup> This research method is a form of reflective artistic analysis employed to examine, review and evaluate the visual data

<sup>473</sup> Tim O'Riley, 'A Discrete Continuity: On the Relation between Research and Art Practice,' *Journal of Research Practice*, 7.1 (2011), p. 1.

<sup>474</sup> Donald Schön, *The Reflective Practitioner: How Professionals Think In Action* (New York, NY: Basic Books, 1984), p. 79.

sets using exploratory artistic investigation, comparative study and ecological pattern recognition<sup>475</sup> to draw out inherent ecological patterns and unconventional affordances. The artworks produced using Reflective Artistic Practice rely on my specialist artistic knowledge to examine how Gibson's ecological approach can be applied through practice-based artistic enquiry. The resulting artworks are evidence of this research process. Gallery exhibition serves as an integral part of the Reflective Artistic Practice method. The exhibition space affords an alternative perspective which allows reflective interaction with the artworks from new vantage points.<sup>476</sup>

### 3.6 Defining the Evaluation Criteria

Employing these methods in my four practice-based artistic research projects, the attentive observation of light becomes an education of attention. In the role of artist-researcher, my subjective perceptual interaction with light serves as a site for both action and reflection, in which my intention and behaviour are integral to the study, influencing the quality, breadth and scope of the research process.

These artistic research projects serve a dual purpose: first, each project serves as a catalyst for 'an education of attention'<sup>477</sup> and aims to elucidate the systemically entwined interrelation between light and perceiver, using the methods outlined above to facilitate an education of attention through the artistic observation of light (RQ2). Second, the four projects are combined and examined as a case study for evaluating the efficacy of Gibson's ecological approach as a framework for the practice-based artistic observation of light (RQ1). As previously mentioned, this approach follows the precedent set by the ecological artist-researcher Keith Armstrong, who uses his process-driven artistic research projects as case studies to draw out 'the complex interrelationships between research and practice' in his work.<sup>478</sup> Analysing my four artistic projects as a cumulative case study in Chapter Eight: Taking the Long View (p. 181), allows me to examine the Gibsonian framework for artistic research against the evaluation criteria I outline below, in order to draw out my final conclusions. To establish the criteria for evaluating both the artistic projects and the final cumulative case study, I draw on the concepts of attunement and refinement, which Gibson suggests can facilitate an education of attention.<sup>479</sup>

<sup>475</sup> Ecological pattern recognition is form of artistic analysis developed for this study. It is applied to reveal patterns and relationships of meaning through prolonged examination of the interrelation between light and observer. Using attentive observation and comparative study, patterns of information are drawn out to bring awareness to the broader systemic interconnections and ecological relations inherent in the artistic practice of observing light. Emergent ecological patterns and meta-patterns may be revealed in variations of light, in the data sets collected or in the artworks produced in the research process. Similarly, patterns of perception and thinking that emerge in the research are observed to evidence the expansion and limits of the artist-researcher's perceptual capacity and evolving ecological worldview. Ecological pattern recognition is embedded as an ongoing concurrent reflective activity (Gray and Malins, *Visualizing Research*, 2004, p. 1) throughout all stages of my practice-based artistic enquiry.

<sup>476</sup> To constrain the scope of this enquiry, this research does not evaluate audience responses to the artworks produced in this study, nor does it extend to the curatorial aspects of the exhibition process.

<sup>477</sup> Gibson, 1979, p. 254.

<sup>478</sup> Armstrong, 2009, p. 187.

<sup>479</sup> Gibson, 1979, pp. 245-249.

**Attunement to Light**

Through the practice of educating attention the perceptual system can become sensitised,<sup>480</sup> or attuned to more refined information. Attunement and refinement are therefore indicators of an education of attention. In this research, light is the focus of attention, and therefore attunement to light can provide evidence of an education of attention. Attunement to light is the first evaluation criterion in this research.

**Emergent Patterns**

An education of attention can reveal patterns of difference which were once unnoticed or indistinct.<sup>481</sup> Patterns of difference become increasingly 'subtle, elaborate, and precise'<sup>482</sup> as attention is refined. Emergent patterns show evidence of attunement and refinement and are therefore proposed as indicators of an education of attention. Emergent patterns thereby serve as the second evaluation criterion in this research.

**Unconventional Affordance**

As new information emerges through an education of attention it offers potential for the discovery of affordances that are neither 'conventional' nor 'normative'.<sup>483</sup> Attunement, attentive observation and refinement open a perceiver to previously unknown informational nuances<sup>484</sup> that can generate an 'unconventional affordance'<sup>485</sup> (Section vi, p. 26). An unconventional affordance is an indicator of an education of attention, and serves as the final evaluation criterion in this investigation.

These criteria are applied against the research processes, visual data sets, artistic outcomes and my own perceptual learning generated in each of the four artistic research projects. To ensure consistency and rigour in my evaluation process, these three criteria are divided into the sub-categories shown in Table 3.4 (p. 101) to identify recurring and common themes that emerge across the four artistic research projects and the final cumulative case study are as follows:

Specification of the Evaluation Criteria	
Evaluation Criteria	Focus of Review and Analysis
Attunement to Light	<ul style="list-style-type: none"> <li>i. as information</li> <li>ii. as focus of attention</li> </ul>
Emergent Patterns	<ul style="list-style-type: none"> <li>i. in light</li> <li>ii. in perceptual awareness</li> <li>iii. in artistic practice</li> </ul>
Unconventional Affordances	<ul style="list-style-type: none"> <li>i. in perceptual awareness</li> <li>ii. in artistic practice</li> <li>iii. in ecological worldview</li> </ul>

Table 3.4: Specification of the Evaluation Criteria (2019), Michaela French.

The new knowledge emerging from the observation of light and the education of attention in these projects is discussed in detail in the Findings and Discussions sections of Chapters Four to Seven (pp. 103-180).

As discussed, the cumulative findings and outcomes from all four projects provide the foundation for the final evaluation, in which, these criteria are applied to assess the efficacy of Gibson's theory as a framework for ecological artistic research in response to the first research question. This final evaluation is presented in Chapter Eight (p. 181).

**3.7 Summary**

In this chapter I have set out the structure of the Gibsonian methodological approach I have developed and applied in my research. In response to my first research question I specified Gibson's concept of 'an education of attention' as the epistemological foundation of my study and outlined the six methodological principles that form the ecological foundation of this research. Using Kurt Lewin's Action Research model, I adapted these principles to define the framework for ecological artistic research that constitutes my original contribution to knowledge. In response to my second research question I defined the three practice-based research methods I employ in my study: Durational Observation, Ecological Lens and Reflective Artistic Practice. Finally, I specified the criteria I use to evaluate my artistic research projects and draw my final conclusions.

In the following four chapters, the Gibsonian methodology and framework for ecological artistic research I have specified here is applied and tested through a series of four artistic research projects, using the attentive observation of light to facilitate an education of attention and to cultivate an ecological worldview.

.....

480 Ibid., p. 57.

481 Ibid., p. 254.

482 Ibid., p. 245.

483 Costall, 2012, p. 85.

484 Withagen and van der Kamp, p. 5.

485 Ibid., p. 4.

Chapter Four: Project One

---

# A Year of Light

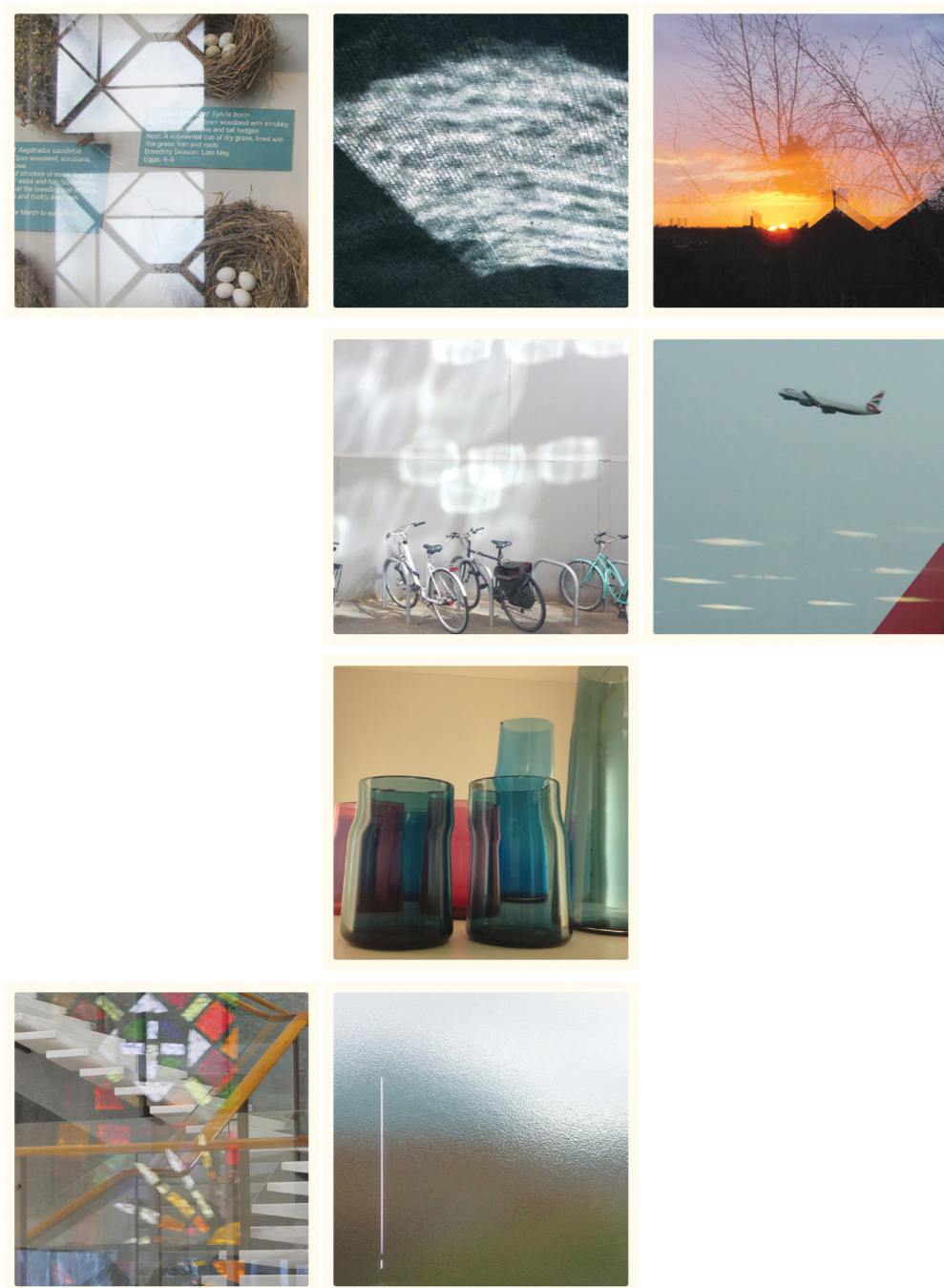

Figure 4.1: *A Year of Light*: 15/365, 29/365, 89/365, 171/365, 226/365, 259/365, 268/365, 315/365 (2015), *Layers of Reflection*, Michaela French.

## 4.1 An Overview of the Practice-based Research

I begin this chapter with an overview of my practice-based research. The structure of this thesis does not reflect the order in which the research enquiry unfolded: the study began with the artistic observation of light. My initial artistic research project *A Year of Light* was a testing ground, an exploratory artistic investigation in which my primary research question was articulated, and Gibson's ecological approach found its position as the epistemological foundation of my research.

Gibson's paradigm offered a bridge between my theoretical enquiry and practice-based investigations, providing a conceptual framework for examining and explicating the ecological experience of light. The artistic research projects presented in the following chapters were undertaken through combined artistic and theoretical enquiry.

The artistic research projects *A Year of Light* (2015) and *The Old Lookout* (2015) were instrumental in developing my Gibsonian methodology, and therefore do not adhere strictly to the research stages outlined in Section 3.4 (p. 96). The final projects, *Daylight Observations* (2016) and *Earth Below Me Sky Above* (2017), follow these research stages as specified. The four projects presented in Chapters Four to Seven are progressive: the findings, experience and new knowledge emerging from one project informs the subsequent cycle of enquiry. This cyclical research approach facilitates the cumulative learning inherent in an education of attention.

The attentive observation of light is the foundation of my practice-based research. I define this artistic practice as a direct and attentive perceptual interaction with radiant and ambient light. Structured patterns and variations in light specify an environment<sup>486</sup> whilst simultaneously illuminating the perceiver, surfaces and substances that are observed. Following Gibson, the perceiver is reciprocally integrated in this interaction as variable light information is recorded to produce data over time.

## 4.2 A Year of Light - Introduction

The initial artistic research project, *A Year of Light* (2015) was a practice-based artistic investigation undertaken from January to December 2015. *A Year of Light* was a starting point for my research that drew upon my existing artistic experience and evolved in conjunction with my theoretical investigation. My research questions were developed during this project which led to the adaptation of Gibson's paradigm as a framework for ecological artistic research.

The following account of the *A Year of Light* project is divided into four parts. First, I present a description of the artistic research process, in which I discuss the intentions of the project and describe the research process. Following this, I specify the research findings and discuss the significance of my research outcomes. I conclude the chapter with a brief summary of this project.

486 Gibson, 1979, p. 63. (emphasis in original)

## 4.3 Description of the Artistic Research Process

### 4.3.1 A Plan of Action

The *A Year of Light* project examined how the interrelation between light and a perceiver might be elucidated through the attentive observation of light. The investigation did not respond to a specific research question; rather, the practice-based artistic enquiry served as a pilot study to identify, focus and articulate the questions that would drive the research. This project was instrumental in establishing the Gibsonian research framework proposed in this thesis, and therefore was not explicitly governed by Gibson's ecological principles. *A Year of Light* was undertaken using the following action research model.<sup>487</sup>

- > Plan
- > Act
- > Observe
- > Reflect

This structure is a simplified adaptation of Kurt Lewin's original five-stage action research model,<sup>488</sup> that I ultimately employed as the foundation of the Gibsonian framework for ecological artistic research (Section 3.4, p. 96).

### 4.3.2 Stage 01: Planning and Intention

My conceptual understanding of light as the *A Year of Light* project commenced was not ecological; rather, I followed mainstream definitions which describe light as electromagnetic radiation comprised of a stream of photons that behave as both particles and waves.<sup>489</sup> Light enabled my visual experience, and the wavelengths that illuminated and coloured my world were part of a much larger spectrum. The four fundamental interactions between light and matter: emission, transmission, absorption

487 Stephen Kemmis and Wilfred Carr, *Becoming Critical: Education Knowledge and Action Research*, (London ; Philadelphia, PA: Routledge, 1986), p. 186.

488 Kemmis and Carr's (1986, p. 186) action research cycle is derived from Kurt Lewin's original five stage Action Research Model (1946) (Figure 2.1, p. 46).

489 Contemporary science defines light as energy: electromagnetic radiation comprised of a stream of photons, or quantum units of energy that are 'proportional in magnitude to the frequency of the radiation' they represent. ('Quantum', in Oxford Dictionary, <<https://en.oxforddictionaries.com/definition/quantum>> [accessed 9 December 2016]) The amount of energy a photon carries determines its behaviour; lower energy photons behave like waves and higher energy photons like particles ('The Electromagnetic Spectrum', *Imagine the Universe*, <<http://imagine.gsfc.nasa.gov/science/toolbox/emspectrum2.html>> [accessed 9 December 2016]). This phenomenon, known as the wave-particle duality was first proposed by Einstein in 1905 (Bruce Watson, *Light: a Radiant History from Creation to the Quantum Age* (New York, NY: Bloomsbury, 2016), pp. 175 -192). The energy of individual photons determine the varying wavelengths that make up the electromagnetic spectrum. Within this spectrum only a small region is visible to the human eye, which detects wavelengths from 400 to 700 nanometers. The energy carried by photons that generate the optical light spectrum range from 3.2 -1.8 electronvolts (eV), where violet is 3.2 eV and red is 1.8 eV. ('The Electromagnetic Spectrum', NASA, 2016).

Michaela French @michaela\_french · 10 Nov 2015  
Image of the Day 310/365 for International Year of Light #IYL2015 kitchen table poppies



🗨️ 🔄 ❤️ 📺

Michaela French @michaela\_french · 23 Dec 2015  
Image of the Day 319/365 for International Year of Light #IYL2015 golden tile reflections



🗨️ 🔄 ❤️ 📺

Figure 4.2: *A Year of Light: 310/365*, 319/365 (2015), Twitter Feed Examples, Michaela French.

and reflection,<sup>490</sup> framed my view and served to filter the light data I collected in my research process.

The intention of *A Year of Light* was simple: I would observe and record a single observation of light each day throughout the year 2015 using attentive observation as my primary method. The data samples I collected were drawn from natural and technologically mediated light sources, such as light bulbs, screen emissions and illuminated signage.

Initially, I positioned myself as artist-researcher in the role of objective observer, considering light and perceiver as separate, co-existing entities. I acknowledged the subjectivity of my position, but at the time I believed an objective approach<sup>491</sup> would ensure quality, 'validity and reliability'<sup>492</sup> in my research. I intended to gather my data from an impartial perspective, looking at light rather than being in light, and therefore did not include my perceptual experience as part of the research process.

*A Year of Light* coincided with UNESCO's International Year of Light 2015 (IYOL2015). This initiative offered a contemporary context in which to situate my investigation. I uploaded my light samples to my Twitter feed each day using the tag #IYL2015 to link my project to this global initiative (Figure 4.2, p. 107). My aim was to contribute an artistic perspective to this cultural platform which focused on the diverse and vital role of light in contemporary life.

The attentive observation of light in *A Year of Light* was undertaken through direct visual perception: the act of looking was independent from the recording medium. To generate a tangible data set, I chose the medium of digital photography,<sup>493</sup> for its capacity to reproduce satisfactory luminance and colour and its portability, which facilitated my site-specific recordings. This medium ensured that my light data was transferable to the UNESCO #IYL2015 initiative. The resulting data set of 365 light images provided the raw material for the artistic investigations discussed later in this section.

The three research methods I used in *A Year of Light* were Durational Observation, Thought Experiment and Reflective Artistic Practice. Each of these methods served as precursors to the final ecological research methods described in Section 3.5 (p. 97).

.....  
490 James M. Palmer, 'The Measurement of Transmission, Absorption, Emission and Reflection,' in *Handbook of Optics: Fundamentals, Techniques, and Design*, ed. by Michael Bass (New York, NY: McGraw-Hill, 1994) <[http://photonics.intec.ugent.be/education/ivpv/res\\_handbook/v2ch25.pdf](http://photonics.intec.ugent.be/education/ivpv/res_handbook/v2ch25.pdf)> [accessed 1 September 2015].

491 Gray and Malins, 2004, pp. 129-130.

492 Ibid.

493 Photography is a medium of light, and whilst this study used photography for the purpose of documenting a specific light event, the actual recording of the light samples was journalistic and/or scientific in approach rather than an artistic process. The artistic component of the data collection process resided in the observation and light selection process, rather than in the photographic medium. I considered the photographs as records or containers of information, which differentiate each light sample from its original temporal and spatial surroundings. That said, I was aware of my impact on the environments I observe, my role in process of choosing each sample, and of my vision in defining the specific information that was recorded.

### Durational Observation

Durational Observation was an adaptation of longitudinal research.<sup>494</sup> A repetitive practice of attentive looking was applied over extended periods of time to reveal information about a chosen subject. Through repetition of clearly defined actions based on specific selection criteria, frequency, duration and recording medium, this method facilitated an exploratory enquiry which culminated in a visual data set.

### Thought Experiment

The Thought Experiment method was applied to provoke new ways of seeing and expanded ecological awareness. Thought experiments have a long association with the study of light: Einstein's imagined 'ride on a beam of light',<sup>495</sup> applied in developing his theory of relativity,<sup>496</sup> is a classic example. The Membrane is Permeable thought experiment was applied to provoke an examination of the idea of permeability between light and perceiver. The Membrane is Permeable did not produce data directly but sought to question and redefine the established boundaries of perception and thinking that framed the project.

### Reflective Artistic Practice

The Reflective Artistic Practice method combined comparative study and pattern recognition in a 'reflective conversation'<sup>497</sup> with the visual data set produced during the Durational Observation process. Practices of 'thinking, making, and reflecting'<sup>498</sup> were employed as artistic analysis to reveal emergent patterns in the recorded light samples. These patterns were reinterpreted through artistic enquiry to create artworks from the data sets, which elucidated the interrelation between light and perceiver.

### 4.3.3 Stage 02: Attentive Observation (Data Collection)

*A Year of Light* began with a single observation and recording of light on January 1st, 2015. This process was repeated every day throughout the year. Selecting each light sample involved attentively observing light throughout my day, waiting for a moment of differentiation<sup>499</sup> in which patterns of light emerged or stood out from other moments. The selection of specific light variables from the 'total spectrum of visual experience'<sup>500</sup> correlated with John Steer's Gibsonian analysis discussed in Section 2.4.4 (p. 61). These differentiations defined the data samples I photographed, and included variations in radiant and ambient light, reflection, emission and transmission, colour, and luminance.

.....  
494 Ruspini, 2003.

495 Grandy, 2009, p. 20.

496 Ibid.

497 Schön, 1984, p. 79.

498 O'Riley, 2011, p. 1.

499 See Section vi: Definition of Terms - Information (p. 23) for a description of differentiation as the basis of ecological information.

500 Steer, 1989, p. 98.

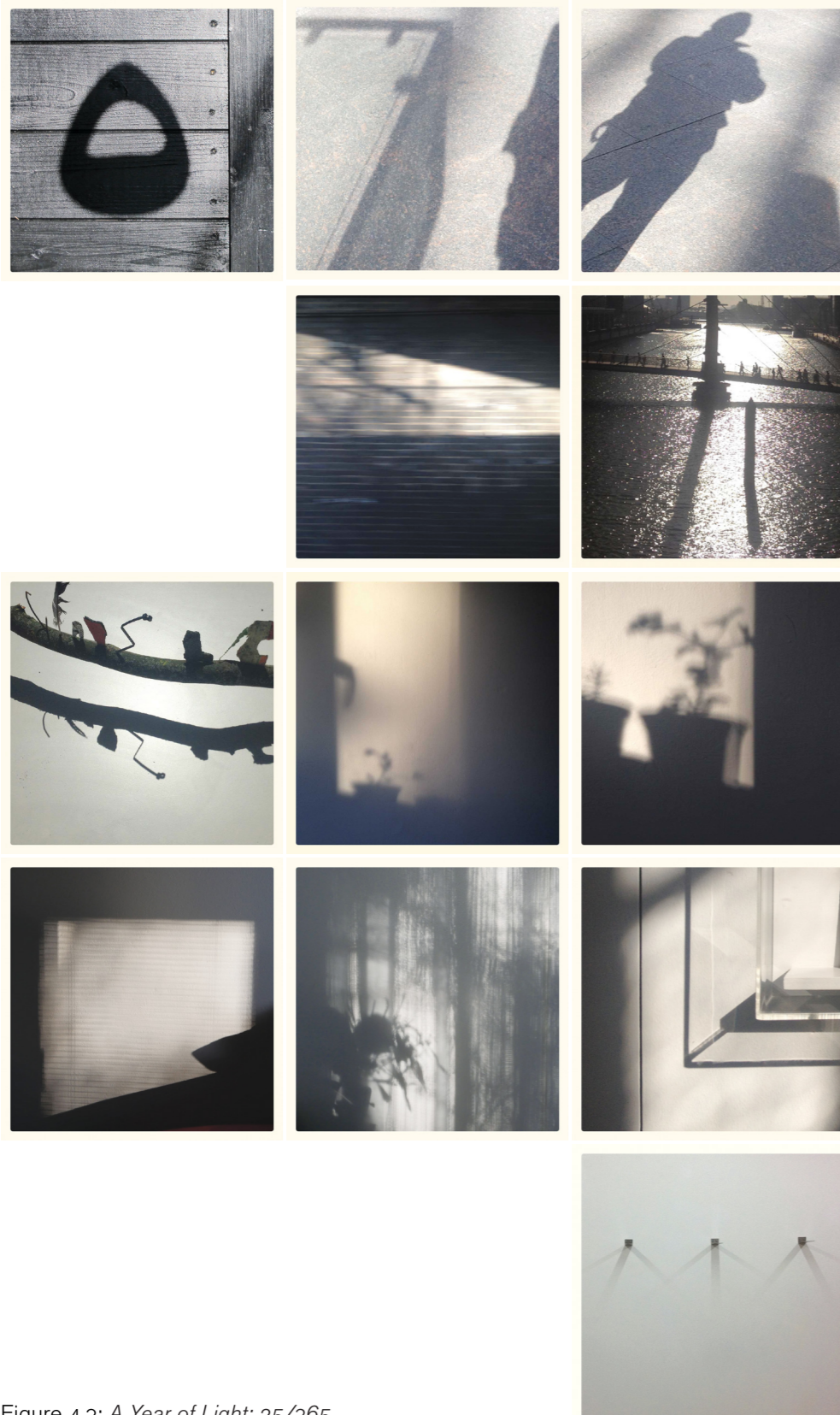

Figure 4.3: *A Year of Light*: 25/365, 74/365, 88/365, 109/365, 110/365, 172/365, 176/365, 211/365, 237/365, 251/365, 264/365, 327/365 (2015), Light and Shadow, Michaela French.

My observation process was highly subjective, and my notion of an objective approach was immediately untenable in my real-world investigation. Theoretically, an impartial observation of light is possible, but experientially the selection of light data was entirely immersive and subjective. The light I observed and recorded each day reflected my perceptual experience as much as it reflected the structures and surfaces of each environment. As a result, my role as artist-researcher evolved into that of subjective observer. Over the year-long project, my eye became increasingly attuned to variations in the interactions between light and matter. I noticed details that were more subtle, and the boundaries between light, object, and observer began to diminish over time. I became aware of themes emerging in the data: layers of reflection (Figure 4.1, p. 104), light and shadow (Figure 4.3, p. 110), radiant light sources (Figure 4.4 p. 112) and seasonal change. As the project progressed, attentive observation altered how I was seeing, until gradually every act of looking became an observation of light.

To examine the interrelation between light and perceiver more closely, I applied the thought experiment *The Membrane is Permeable*. This experiment was embedded in my attentive observation process as a provocation, proposing the body as permeable to light. Building on the idea of the artist-researcher as subjective observer, this experiment aimed to reframe my understanding and experience of the interface between my body, light and world. Light was transmitted into the lens of my eye and reflected and absorbed by my skin. My body was far from a self-contained entity: I was no longer looking *at* light – instead, I was immersed *in* light, impacted by it and interacting with it directly. Once again, the artist-researcher role shifted, this time from subjective observer to systemically entwined perceiver. To reflect this change in perspective, I acknowledged my presence in *A Year of Light* by including my own shadow in selected light samples (Figure 4.5, p. 115).

#### 4.3.4 Stage 03: Reflective Artistic Practice

This observational data collection process resulted in *A Year of Light Visual Data Set* (2015), a collection of 365 digital photographs that serve as a record of my year-long artistic observation. Throughout the project, I disseminated my images of light via my Twitter feed to contribute to the UNESCO #IYL2015 (Figure 4.2, p. 107). The linear format of the Twitter feed reflected the repetitive temporal format of my durational study but was unsuitable for analysing the completed visual data set.

To overcome this, I printed the data set as 365 individual photographic images. These physical images allowed me to review the visual data set using a physical action of sorting and comparing to reveal emergent patterns and different ways of seeing. I used my original criteria of emission, transmission, reflection and absorption as the starting point for my analysis. Emission and reflection were the simplest to identify, as they offered clear visual cues; absorption was challenging, as it was primarily indicated by temperature and not visual cues. From these main categories I sought out sub-themes, ordering the 365 images based on ambient and radiant light (Figure 4.5, p. 115), shadow, layers of reflection (Figure 4.1, p. 104), hue, saturation, luminance and shape. This comparative study of the images revealed the multiplicity and diversity of the light I had observed over the year.

To extend this visual analysis, *A Year of Light Visual Data Set* (2015) was exhibited





Figure 4.4: *A Year of Light*: 12/365, 21/365, 56/365, 82/365, 123/365, 180/365, 182/365, 192/365, 218/365, 271/365, 295/365, 335/365 (2015), Radiant Light, Michaela French.

in two gallery exhibitions: *The Observer Effect* (2016) (Figure 4.6 and 4.7, p. 119)<sup>501</sup> and *Catching the Light* (2016) (Figure 4.8, p.120)<sup>502</sup> The 365 individual images were pinned directly onto the gallery wall in a grid structure in the order they had been recorded. These two exhibitions provided the opportunity to reflect on my entire year of light observations in a single view. This afforded a new vantage point to reflect upon the impact my year-long project had had on my perceptual awareness and my understanding of the interrelation between light and perceiver.

The final artistic outcome of this project was a limited-edition artist's book, *A Year of Light* (2017) (Figure 4.9 and 4.10, p. 122). This book compiled the 365 light samples into a single volume, intentionally designed to fit into the hand of the reader. The open spine revealed glimpses of the light samples inside the book, and hand-stitched binding rendered the book highly flexible when held. The instability of the book invited the reader into an active process of looking, which embedded my original light samples within the reader's own observation process. In the following sections I present the research findings and elaborate on these artistic outcomes.

#### 4.4 A Year of Light - Findings

Below I articulate the findings from the *A Year of Light* project using the evaluation criteria specified in Section 3.6 (p. 99):<sup>503</sup>

##### Attunement to Light

01. The repetitive practice of observing light initiated a change in my focus of attention. Visual hierarchy became attuned to variations in the luminance, quality and structure,<sup>504</sup> of light as a priority over the objects and substances it illuminated.
02. The concept of light as information and the non-visual impact of light on the body were increasingly integrated as I became attuned to more subtle and precise experiential information<sup>505</sup> through attentive observation and refined differentiation.

##### Emergent Patterns

03. The extended duration of *A Year of Light*, combined with the prolonged repetitive process of the attentive observation of light, were effective strategies for reframing established patterns of perception and thinking over time.

501 'The Observer Effect', Hockney Gallery, Royal College of Art, London, February 2016.

502 'Catching the Light', Sidney Cooper Gallery, Canterbury UK, August 2016.

503 These criteria were not defined as the *A Year of Light* project took place but in the larger context of the research it is valuable that the findings are consistent across all four artistic research projects in order to facilitate a final evaluation in response to my research questions.

504 Gibson, 1979. p. 249.

505 Ibid., p. 245.

04. The concept of a single repeated action contributing to a larger structure emerged as a recurring theme throughout the *A Year of Light* investigation. This pattern created a symmetry of scale that reflected a shift toward an ecological systems perspective.

#### Unconventional Affordances

05. My role in the attentive observation process evolved over the duration of the project from objective observer to systemically interconnected perceiver. This change in perspective integrated my analytical understanding more closely with my perceptual experience, situating me in an immersive reciprocal interrelation with the light I observed.
06. Over the duration of the *A Year of Light* investigation, contextualising the experiential artistic research practice demanded an increasingly ecological perspective to account for my evolving conception of light.

## 4.5 Discussion: An Emerging Ecology of Light

### 4.5.1 An Emerging Ecological Perspective

The stated intention of *A Year of Light* was to examine how artistic research might elucidate the interrelation between light and a perceiver using attentive observation as the primary method. The findings presented here, combined with the new knowledge emerging from this project, indicated that artistic research could clarify this relationship when framed by an ecological approach to visual perception.

Over the year-long project my practice-based artistic enquiry co-evolved with a concurrent theoretical investigation that directed my thinking toward an ecological perspective. My theoretical exploration traced a history of light which began with the metaphysics of Robert Grosseteste's medieval treatise *De Luce - On Light* (1225)<sup>506</sup> and Robert Fludd's journey to edge of human knowledge in *Utriusque Cosmi* (1617).<sup>507</sup> I navigated humanity's conception of light through manifestations of the divine, Newtonian physics, electromagnetic radiation, relativity and quantum duality, and concluded in the binary on/off light of a single pixel discussed in Sean Cubitt's *The Practice of Light* (2014).<sup>508</sup>

As with my own study, these evolving conceptions of light corresponded with the dominant worldview of each epoch. The light I observed was informed by the prevailing scientific thinking of my era, as evidenced in my observation criteria of emission, transmission, reflection and absorption. During this project, two books precipitated

506 Robert Grosseteste, *On Light* (De Luce), trans. by Clare C Riedl (Milwaukee, WI: Marquette University Press, 1942).

507 Robert Fludd, *Utriusque Cosmi*, 1617, <<https://ia801406.us.archive.org/16/items/utrusquecosmima01flud/utrusquecosmima01flud.pdf>> [accessed 22 March 2017].

508 Cubitt, 2014.

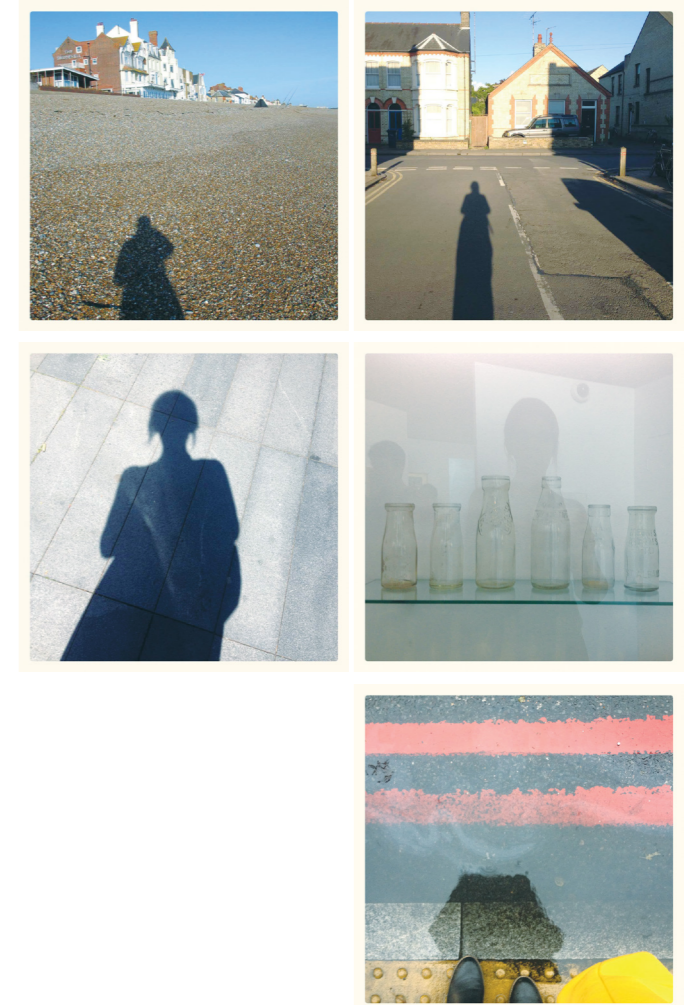

Figure 4.5: *A Year of Light*: 120/365, 149/365, 173/365, 258/365, 332/365 (2015), *Me and my Shadow*, Michaela French.

my shift toward an ecological perspective. Arthur Zajonc's *Catching the Light*<sup>509</sup> and David A. Grandy's *The Speed of Light*<sup>510</sup> were based on scientific thinking but offered an expanded view which explored humanity's interconnected relationship with light and introduced me to Gibson's ecological approach to visual perception.<sup>511</sup>

In *Catching the Light*,<sup>512</sup> physicist Arthur Zajonc proposed that humanity's understanding of light co-evolved with its conception of space.<sup>513</sup> By emphasising a particular interpretation of light, each age revealed its cultural predilections.<sup>514</sup>

spiritual space - divine light

perspective space - geometrical light

material space - substantial light<sup>515</sup>

In considering the cultural predilections that defined the light I observed in *A Year of Light* I devised additional pairings to reflect the mainstream understanding of light that informed my investigation:

scientific space - harnessed light

quantum space - dualist light

digital space - technological light

Whilst these pairs effectively defined my analytical understanding of light, there was a clear discrepancy between this and my perceptual experience. Conceiving the world is different from perceiving it, but, according to Gibson, 'one is continuous with the other'.<sup>516</sup> The way I conceived light in my study was not continuous with my inherently ecological experience of light. This inconsistency was most apparent in my changing role as artist-researcher in the *A Year of Light* project. My intention to observe light from a non-ecological, objective position reflected my initial theoretical position, but this conceptual approach was not viable in my experiential real-world research. The evolving role of the artist-researcher brought my subjective perceptual experience into the research process as my conception of light shifted toward an ecological perspective (Finding 05). This new level of description was initiated by my integrated practice-based and theoretical investigations.

The findings emerging from *A Year of Light* indicated that an ecological approach

509 Zajonc, 1995.

510 Grandy, 2009.

511 As discussed, I encountered Gibson's ecological theory in the IED programme reading list and in the writing of Tim Ingold (Section 1.1).

512 Zajonc, 1995.

513 Ibid., p.99.

514 Ibid., p.99.

515 Ibid., p.99.

516 Gibson, 1979, p. 258.

could afford an effective way to align my critical position with my evolving observational experience (Finding 06) Adopting this approach allowed me to redefine the conception of light that would frame my research:

#### holistic space - ecological light

From this position the relationship between light and body was implicitly knowable, but to explicate my experience of light in a rigorous academic research study required an ecological methodology capable of ensuring the validity and reliability of the data, findings and outcomes generated through this highly subjective investigation. Gibson's ecological theory provided an apposite conceptual foundation for this research framework. From this ecological position and in response to the findings from *A Year of Light*, I formulated the two research questions that would drive my research forward:

1. Which principles and concepts from Gibson's ecological approach to visual perception might be adapted and applied to frame ecological artistic research that facilitates an education of attention through the rigorous observation of light?
2. What practice-based methods emerging from a Gibsonian research framework might be applied through artistic practice to cultivate an ecological worldview?

My changing role as artist-researcher (Finding 05), combined with the need for an ecological perspective (Finding 06), emerged as unconventional affordances which ultimately led to the development of my Gibsonian framework for ecological artistic research.

#### 4.5.2 Attunement to Light

Light is 'expansive beyond what it illuminates',<sup>517</sup> and the ingress of light into the body was examined using the thought experiment The Membrane is Permeable. Two scientific studies examining the non-visual impact of light on human physiology were influential in this experiment. Kobayashi et al. demonstrated that the human body rhythmically emits ultra-weak photons in the visible spectrum as a by-product of metabolic reactions,<sup>518</sup> and according to Sun et al. biophotons enable cell-to-cell communication and influence the structure and behaviour of DNA in all living organisms.<sup>519</sup>

Framed by this knowledge, examining the concept of permeability through the

517 Grandy, 2009. p. 26.

518 Masaki Kobayashi, Daisuke Kikuchi, and Hitoshi Okamura, 'Imaging of Ultraweak Spontaneous Photon Emission from Human Body Displaying Diurnal Rhythm.', *PLoS ONE* 4.7 (2009), E6256. Doi:10.1371/Journal.Pone.0006256, <http://www.plosone.org/article/fetchObject.action?uri=info:doi/10.1371/journal.pone.0006256&representation=PDF> [accessed 3 April 2015].

519 Yan Sun, Chao Wang and Jiawei Dai, 'Biophotons as Neural Communication Signals Demonstrated by in Situ Biophoton Autography', *Photochem. Photobiol. Sci.* 9.3 (March 2010)

attentive observation of light contributed to the ecological perspective that emerged from *A Year of Light* (Finding 02). Over the year-long enquiry my relationship with light became increasingly and consciously integrated. Gibson's concepts of mutuality and ecological reciprocity mirrored and articulated my perceptual experience. The focused repetition of attentive observation initiated a permanent change in my visual perception (Finding 01), moving away from an object-oriented view, as variations in the luminance, quality and structure of light emerged as my new focus of attention.

Gibson's notion of light as information took on new significance as a result of this attunement (Finding 02). My observations expanded beyond the initial criteria of the interaction between light and matter – emission, transmission, reflection and absorption – to include the impact of non-visual light and my own perceptual experience. Observing these different types of light information brought an awareness of the overlapping processes of my visual and haptic perceptual systems. Over time, this led to a refinement in the information I was able to perceive and brought a new level of understanding of light as the subject of my research.

#### 4.5.3 Emergent Patterns

Two significant patterns emerged from the *A Year of Light* project. Patterns of change in my perceptual awareness and thinking (Finding 03) emerged as the project progressed. These changes included my shift to an ecological perspective, a refined attunement to light and a reframing of my role as artist-researcher. The repetitive and prolonged process of attentive observation, in combination with my theoretical enquiry and the experiment *The Membrane is Permeable* were effective in facilitating these changes. The resulting data set served as a record of my evolving patterns of visual perception over the year. The extended duration of the *A Year of Light* project was significant in generating these outcomes (Finding 03).

The combination of methods, practices, and approach I applied in *A Year of Light* enabled the research process to facilitate an education of attention through the artistic observation of light and contributed to an emerging ecological perspective. Based on these findings, I resolved to integrate these strategies into the Gibsonian research framework I developed for my subsequent artistic research projects.

The second pattern to emerge from *A Year of Light* was a recurring theme of a single repeated action contributing to a larger structure or outcome (Finding 04). This cumulative pattern became apparent in my reflective artistic practice whilst analysing, sorting and comparing the 365 images of the visual data set.

Once observed, this pattern became evident across many levels of the project: in the individual light samples in the visual data set, in the single pages of the artist's book, in the daily process of looking and the cumulative learning of an education of attention. This pattern was also evident in the structure of the *A Year of Light* project itself. Each small act of attentive observation, when repeated over an extended period of time brought new levels of understanding to the rich multi-faceted experience of visual perception. This seemingly simple pattern is significant, as it reflects the power of a small repetitive action to precipitate increased perceptual capacity and awareness. These emergent patterns are indicators of attunement and refinement, and therefore serve as evidence of an education of attention.



Figure 4.6 and 4.7: *A Year of Light - 365 Observations* (2015), Michaela French, (London: 'The Observer Effect', Hockney Gallery, Royal College of Art, 2016).

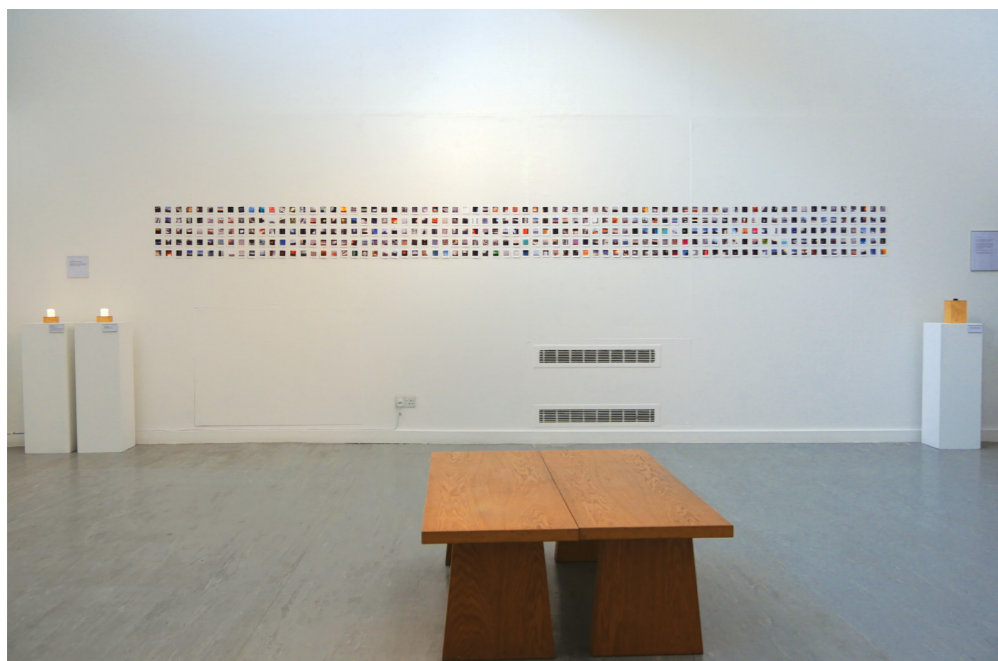

## 4.6 A Year of Light - Summary

*A Year of Light* was an exploratory pilot study which used practice-based research to examine how the interrelation between light and a perceiver might be elucidated through the observation of light. The project did not respond to an existing research question; rather, it was in response to this year-long artistic and theoretical investigation that I formulated the two research questions that frame this research.

The action research model provided an effective structure for this artistic research project, and the three research methods I employed – Durational Observation, Thought Experiment, Reflective Artistic Practice – were well suited to the practice-based artistic observation of light. These methods successfully facilitated an education of attention and served as precursors to the final ecological research methods described in Section 3.5 (p. 97).

The year-long duration of the enquiry proved critical in generating the findings and new knowledge that emerged from the *A Year of Light* project. The outcomes of the enquiry contributed to the UNESCO #IYL2015 initiative, and as my findings show, significantly impacted my attunement to light, altered my way of seeing and reframed the worldview that defined my enquiry. This project revealed the need for a research methodology which could facilitate an experiential artistic investigation of light and led to the Gibsonian research framework I propose in this thesis.

Following Gibson's proposition that the development of perceptual awareness by educating attention is limited only by a perceiver's capacity and motivation to acquire knowledge,<sup>520</sup> I undertook my second artistic research project, *The Old Lookout* (2015), from an entirely ecological perspective.

Figure 4.8: *A Year of Light - 365 Observations* (2015), Michaela French, 'Catching the Light', Sidney Cooper Gallery, Canterbury, UK.

.....  
520 Gibson, 1979. p. 57.



Chapter Five: Project Two

---

## The Old Lookout



Figure 4.9: *A Year of Light - Artist's Book* (2017), Michaela French.

Figure 4.10: *A Year of Light - Artist's Book* (2017), Michaela French

## 5.1 The Old Lookout - Introduction

In the previous chapter I discussed how the *A Year of Light* project initiated a perceptual shift toward an ecological understanding of light, and signalled the need for an ecological approach in my research. The findings and outcomes from this artistic research project contributed to the research questions that frame this study.

In the midst of the *A Year of Light* project, a ten-day artist residency at the Old Lookout studio in Broadstairs, UK, provided the context for my second artistic research project, *The Old Lookout* (2015). The residency offered an opportunity to build on the learning from *A Year of Light*, facilitating further examination of my attunement to light, the impact of durational observation, my awareness of patterns of repetition and my evolving ecological worldview. *The Old Lookout* project refined the research methods from *A Year of Light* to define the final methods specified in Section 3.5 (p. 97): Durational Observation, Ecological Lens and Reflective Artistic Practice. Using these methods, governed by Gibson's concepts of the ambient optic array, light as information, mutuality and reciprocity, *The Old Lookout* project aimed to demonstrate that artistic research based on Gibson's ecological principles could facilitate an education of attention through the rigorous observation of light.

## 5.2 Description of the Artistic Research Process

### 5.2.1 Setting the Intention

*The Old Lookout* project was an intensive ten-day investigation which overlapped with the *A Year of Light* project taking place in July 2015. *The Old Lookout* project was based on Gibson's ecological principles, and contributed to the development of the Gibsonian research framework proposed in this thesis.

Whilst still a work-in-progress, I applied the five stages of the Gibsonian ecological artistic research framework (Section 3.4, p. 96) to *The Old Lookout* project. These following research stages were used to structure the investigation and serve as section titles in the project description:

- 01: Light as Information (Ecological Information)
- 02: A Perceptual Ecology (Ecological Knowing)
- 03: Attentive Observation
- 04: Ecological Pattern
- 05: A New Level of Description

### 5.2.2 Stage 01: Light as Information

Three ideas from the *A Year of Light* project determined how light was defined in *The Old Lookout* investigation: light was defined by Gibson's concept of the ambient optic array; light was considered as both visual and non-visual information, integrating the notion of the body as permeable; light was conceived as ecological, envisaged in the context of holistic space as defined in the previous project (Section 4.5, p. 115-117).

From this foundation, *The Old Lookout* enquiry examined three light recording techniques to determine which could best facilitate an education of attention through

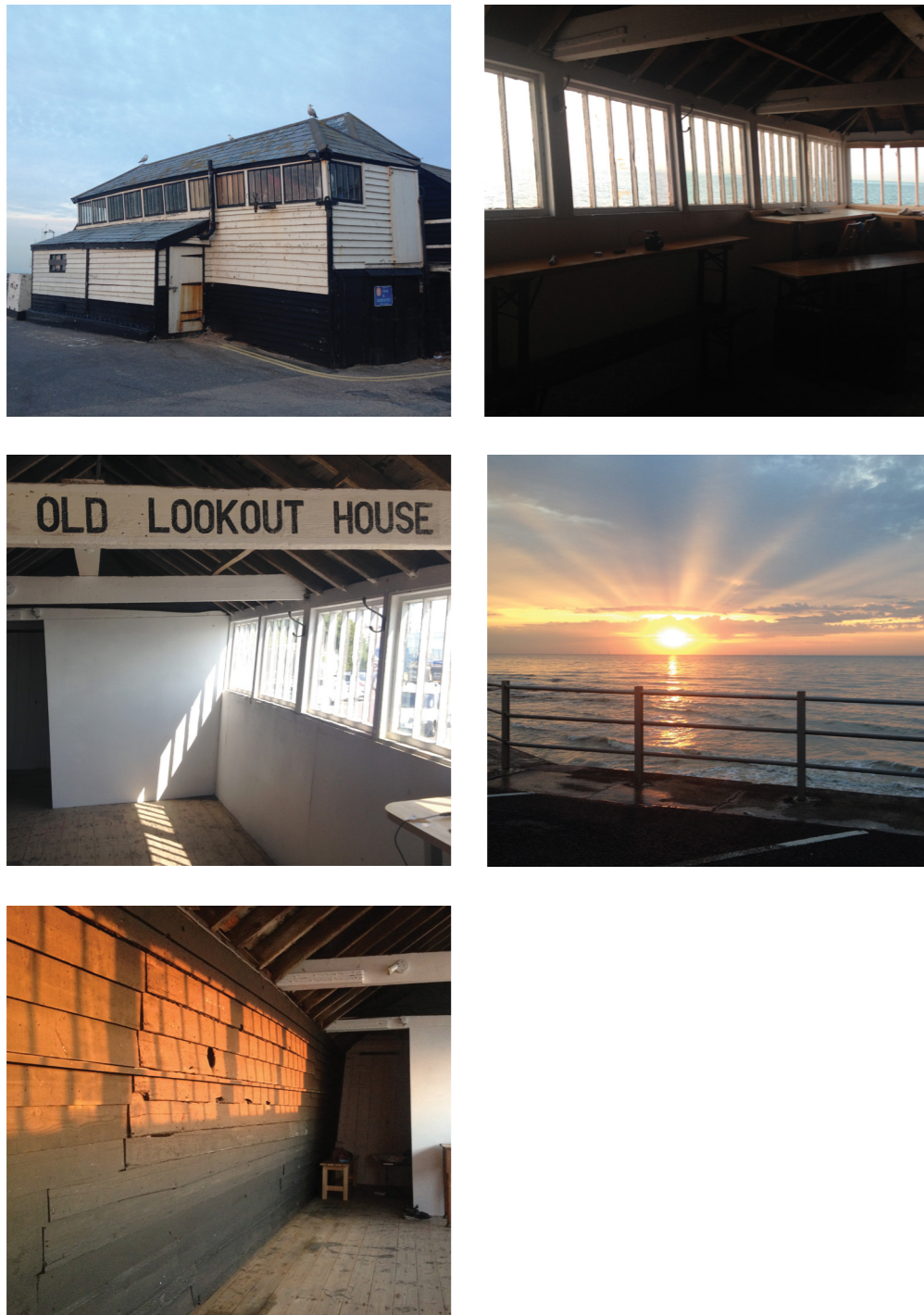

Figure 5.1: The Old Lookout Studio: exterior/interior, Broadstairs Harbour, UK (2015), Michaela French.

the attentive observation of light, and which might most successfully elucidate the ecological interrelation between light and perceiver. The three techniques for recording light information in this investigation were:

- > time-lapse photography
- > digital light sensor
- > observation by direct visual perception with digital colour sampling

These techniques were tested concurrently in the durational observation process to produce three corresponding visual data sets, each with different light information (Figure 5.2, p. 129). A detailed account of each recording technique will be presented later in this chapter.

### 5.2.3 Stage 02: A Perceptual Ecology

Light was a dominant feature in The Old Lookout studio. The small wooden building perched on the end of a pier afforded broad views out to sea (Figure 5.1, p. 126). In the ten days I spent in this space, I followed the rhythm of the rising and setting sun and did not use electric lighting.

In articulating the scope of *The Old Lookout* project the observational processes and my role as artist-researcher were governed by Gibson's ecological principles. As such, my subjective perceptual experience, exploratory action and presence in the environment were integral to the research. Light was the agent for my vision, and simultaneously provided the information for observation and data collection. This was a perceptual ecology in which the simple act of looking entailed the co-perceiving of the self and the environment in an immersive field of light that reached from the studio to the far horizon where sea met sky. Initially I questioned the quality and reliability of my subjective research process. I addressed this concern by combining subjective analogue techniques with digital recording technologies to ensure my data could be verified and validated. When *The Old Lookout* enquiry commenced, I believed the digital technologies would provide more accurate and reliable data. My perspective had changed significantly by the end of the project.

The research methods used in *The Old Lookout* correspond with those described in Section 3.5 (p. 97). A detailed account of how these methods were applied in this project will be presented later in this discussion.

#### Durational Observation

Durational Observation used attentive observation to study and record fluctuations and variations in light over the ten-day period of this project. As described in Section 3.5 (p. 97), the recorded variables include the luminance, hue and quality of light and integrate the perceptual experience of the artist-researcher. The Durational Observation method addressed the research questions in two ways in this project: it tested different recording techniques to identify those best suited to a Gibsonian ecological framework (RQ2) and applied the six Gibsonian principles through the artistic enquiry to establish a framework for ecological artistic research (RQ1).



### Ecological Lens

Following the success of the thought experiment method in *A Year of Light*, a second Ecological Lens, *There is No Membrane*, was applied in *The Old Lookout* enquiry. The Ecological Lens method (Section 3.5, p. 97) facilitates new ways of examining the interrelation between light and perceiver by disrupting established patterns of perception and thinking. *There is No Membrane* was a provocation which invited renewed examination of my conceived perceptual boundaries in relation to the perceptual ecology I defined in *The Old Lookout* project. This Ecological Lens influenced the data sets, artworks and ecological thinking that emerged from this enquiry.

### Reflective Artistic Practice

The Reflective Artistic Practice research method combined comparative study, pattern recognition and reflective analysis, as detailed in Section 3.5 (p. 97). Drawing on the experiential knowledge gained in the durational observation process, this method was applied to reveal emergent patterns in the collected light data sets and produce artworks through a 'reflective conversation with the materials of a situation'.<sup>521</sup> In this project the situation was the expanding perceptual light ecology of the Old Lookout studio.

#### 5.2.4 Stage 03: Attentive Observation (Data Collection)

*The Old Lookout* residency began slowly: I took time to observe the light in the Old Lookout studio. At 4.55am, deep orange-red sunlight appeared on the back wall, tracing across the room until shortly after midday; the sun moved overhead and the shadow of the building travelled out across the pier until darkness. This cycle of light repeated daily.

As I became attuned to these rhythms of light, I began observing and recording light data sets using three concurrent recording techniques. I used time-lapse photography to record digital images of light. I set the frame and using an intervalometer specified the frequency of the recordings. The camera was re-framed intermittently as the light travelled through the studio. This technique produced a collection of image sequences which recorded fluctuations in light over a number of days.

Simultaneously, a digital light sensor was set to record ambient light. The sensor was placed in a fixed location out of direct sunlight and programmed to record a light sample every ten seconds. The sensor recorded light as numerical data, producing digital files which specified the variables of luminance, red, green and blue in each light reading.

Direct visual perception<sup>522</sup> was my final observation technique. Selecting two points of observation at the far horizon, one sea, one sky, I observed fluctuations in colour and luminance at five-minute intervals. As with the previous project, the observation process was independent of the recording medium. I intended to record variations in the light by painting colour swatches, but they were a dismal failure (Figure 5.2, p. 129). I could not

.....

<sup>521</sup> Schön, 1984, p. 79.

<sup>522</sup> According to Gibson, '*direct perception* is the activity of getting information from the ambient array of light [...] a process of *information* pickup that involves the exploratory activity of looking around, getting around, and looking at things. This is quite different from the supposed activity of getting information from the inputs of the optic nerves'. (1979, p. 147. (emphasis in original)).

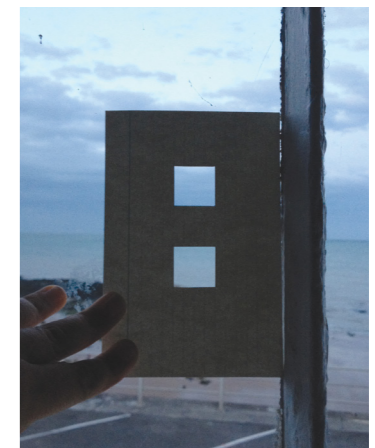
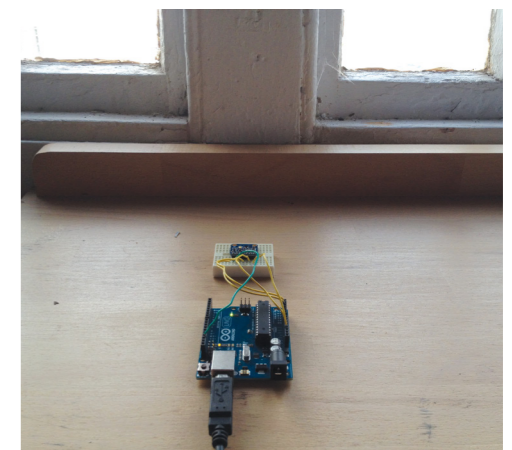

Figure 5.2: Three Data Collection Techniques: recording light samples time-lapse photography, digital light sensor, and subjective observations by eye, with initial paint swatch tests (2015), Michaela French, The Old Lookout Studio, Broadstairs UK.

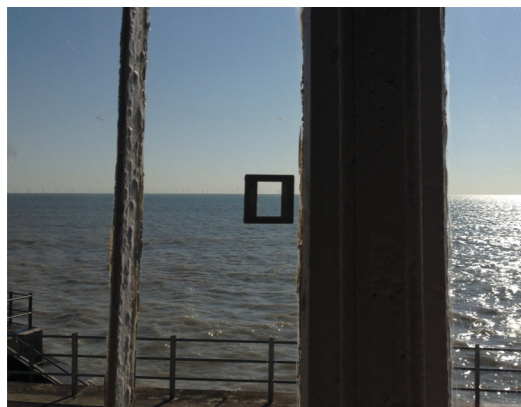
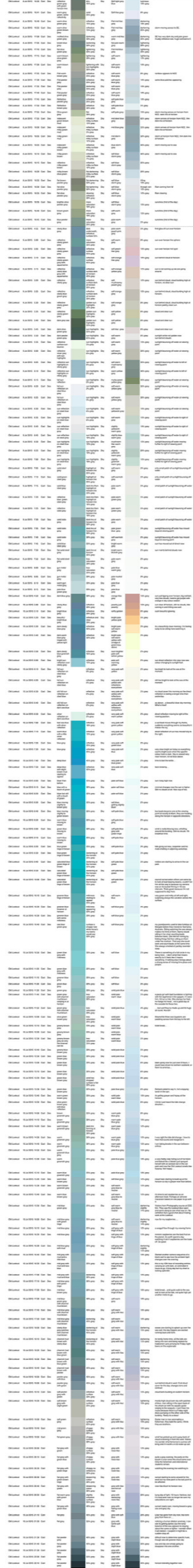

Figure 5.3: The first Subjective Colour Swatch data-collection observation (2015) Michaela French,

Figure 5.4: The completed Subjective Colour Swatch (2015), Michaela French, The Old Lookout Studio, Broadstairs UK.



capture the quality of light with the pigments I had available. The only other recording system I had in the studio was digital spreadsheet software. I was not confident this tool would be capable of recording the light fluctuations I observed, nor did I expect it to produce usable data, but it was my only option.

Throughout the day, every five minutes until darkness fell at 10.30pm, I filled two cells in the spreadsheet with colour and luminance information. Using the RGB colour settings in the software, I matched and translated the light I saw as closely as possible into digital RGB colour space (Figure 5.3, p. 130).<sup>523</sup> Alongside this, I recorded field notes about my experience and observations of the broader environment. My laptop was small, showing only a few samples at a time; when I zoomed out to view the data list, I found I had created something surprisingly beautiful (Figure 5.4, p. 130). At 16.50 hours, I recorded the following note:

‘this is my 12th hour of recording entries, carrying on until dark, an estimated 4 hours to go. A long day but my chart is looking splendid’.

The cumulative colour swatches showed a record of light: it was data, it was landscape, it was reflective of a place, of time, and my experience of seeing. Out of my failed painting process, an unconventional affordance (Section 3.3, p. 93-95) emerged. Through exploratory practice, and by attending to each small repetition of looking and recording, I devised a rigorous method for the artistic observation of light, the Subjective Colour Swatch technique (Figure 5.5, p. 133). This was a critical moment in the research process, in which I became an effective, flexible and efficient light sensor.

Embedded into this attentive observation process was a second Ecological Lens. There is No Membrane extended the notion of the permeable body I had established in the previous project. This lens prompted an examination of the conceived boundaries between the self and the internal and external perceptual experience of the world.

### 5.2.5 Stage 04: Ecological Pattern (Reflective Artistic Practice)

The attentive observation process undertaken in *The Old Lookout* project produced three data sets: photographic image sequences, numeric light data tables, and the Subjective Colour Swatch spreadsheet. These data sets provided the raw material for my reflective artistic enquiry which served as a process of analysis and produced a collection of light-based artworks for exhibition.

Using Reflective Artistic Practice, I analysed the three data sets, comparing the photographic, numeric and subjective light samples from the same moments in time to triangulate the data, aiming to reveal visual correlations, overlapping information and emergent patterns. A number of themes emerged from this process: the recurring idea of a repetitive action contributing to larger whole, the interrelation and rhythm of light and dark and a recurring pattern of repetitive cycles of change over time.

These themes influenced my artistic process, in which I used the data sets to explore

<sup>523</sup> I drew on my existing knowledge in the process of translating colour into digital colour space. I have studied colour theory and have extensive experience of colour grading and colour matching in digital production environments.

Old Lookout	10 Jul 2015	12.50	East	Sea	green blue brown grey		20% grey	Sky	solid pale blue	7% grey	
Old Lookout	10 Jul 2015	13.00	East	Sea	green blue brown grey		20% grey	Sky	solid pale blue	6% grey	been going now for just over 8 hours, I could have driven to northern scotland, or flown to america...
Old Lookout	10 Jul 2015	13.10	East	Sea	green blue brown grey		20% grey	Sky	solid pale blue	6% grey	
Old Lookout	10 Jul 2015	13.20	East	Sea	green blue brown grey		wind has dropped surface is flat 20% grey	Sky	solid pale blue	8% grey	
Old Lookout	10 Jul 2015	13.30	East	Sea	green blue brown grey		20% grey	Sky	pale blue grey	6% grey	Richard called to say hi, he's enjoying lunch in the sun.
Old Lookout	10 Jul 2015	13.40	East	Sea	warm green brown grey		20% grey	Sky	solid pale warm blue	10% grey	its getting greyer and hazey at the horizon.
Old Lookout	10 Jul 2015	13.50	East	Sea	olive green brown grey with blue reflection		20% grey	Sky	solid pale blue	8% grey	I think I just heard the tide change direction...
Old Lookout	10 Jul 2015	14.00	East	Sea	brown greenish grey		25% grey	Sky	warm pale blue grey	8% grey	
Old Lookout	10 Jul 2015	14.10	East	Sea	brown greenish grey		30% grey	Sky	warm pale blue grey	10% grey	
Old Lookout	10 Jul 2015	14.20	East	Sea	warm brown greenish grey		dark line forming at horizon 30% grey	Sky	warm pale blue grey	12% grey	
Old Lookout	10 Jul 2015	14.30	East	Sea	warm greenish grey		30% grey	Sky	warm pale blue grey	12% grey	I was right the tide did change. I love to hear that sound and recognise it.
Old Lookout	10 Jul 2015	14.40	East	Sea	warm greenish grey		30% grey	Sky	warm pale blue grey	15% grey	I am taking breaks in the sun between entries
Old Lookout	10 Jul 2015	14.50	East	Sea	warm greenish blue grey		25% grey	Sky	pale blue grey	15% grey	
Old Lookout	10 Jul 2015	15.00	East	Sea	warm greenish grey		25% grey	Sky	pale blue grey	10% grey	a very flabby lady falling out of her bikini and baked like a lobster just sprayed herself with an aerosol can in the car park and now the Old Lookout smells like flyspray. Not happy....
Old Lookout	10 Jul 2015	15.10	East	Sea	warm blue greenish grey		25% grey	Sky	pale blue grey	10% grey	
Old Lookout	10 Jul 2015	15.20	East	Sea	warm blue brown grey		25% grey	Sky	soft blue grey	12% grey	cloud haze starting to build up at the horizon so sky is greyer now than before.
Old Lookout	10 Jul 2015	15.30	East	Sea	warm brown greenish grey		25% grey	Sky	soft warm grey blue to neutral	12% grey	
Old Lookout	10 Jul 2015	15.40	East	Sea	warm blue brown grey		25% grey	Sky	soft warm grey blue to neutral	12% grey	it's time to eat raspberries as an afternoon treat. Perhaps an almond macaroon baked on rice paper to go with it.
Old Lookout	10 Jul 2015	15.50	East	Sea	mid blue green grey		25% grey	Sky	soft warm grey blue to neutral	darkening slightly 14% grey	Visitors from Photography course at CCC Uni. They saw the Lookout door open and came along to see what was on. No exhibition but a good chat about making work at the Lookout.
Old Lookout	10 Jul 2015	16.00	East	Sea	mid blue grey with green tinge		25% grey	Sky	soft warm grey blue to neutral	darkening slightly 14% grey	now for my raspberries....
Old Lookout	10 Jul 2015	16.10	East	Sea	mid blue grey		25% grey	Sky	soft grey with tinge of blue	12% grey	a seagull flew through my viewing frame
Old Lookout	10 Jul 2015	16.20	East	Sea	mid blue grey		25% grey	Sky	soft grey with tinge of blue	12% grey	mmmm raspberries are the best fruit on the planet, its worth spend a day watching it roll if raspberries are the trade off. So good.
Old Lookout	10 Jul 2015	16.30	East	Sea	mid blue grey with mud		25% grey	Sky	soft grey with tinge of blue	darkening slightly 15% grey	
Old Lookout	10 Jul 2015	16.40	East	Sea	mid grey with mud and a little blue		25% grey	Sky	soft grey with tinge of blue	10% grey	Started another camera sequence of a blank wall to see how the ambient light changes over the evening
Old Lookout	10 Jul 2015	16.50	East	Sea	mid grey with mud and less blue		25% grey	Sky	soft grey with tinge of blue green	13% grey	this is my 12th hour of recording entries, carrying on until dark, an estimated 4 hours to go. A long day but my chart is looking splendid.
Old Lookout	10 Jul 2015	17.00	East	Sea	mid grey with mud and blue		darkening 30% grey	Sky	soft grey with tinge of blue	10% grey	
Old Lookout	10 Jul 2015	17.10	East	Sea	mid blue grey with green tinge		30% grey	Sky	soft grey with tinge of blue	10% grey	
Old Lookout	10 Jul 2015	17.20	East	Sea	mid blue brown grey		30% grey	Sky	soft grey with tinge of blue	10% grey	toilet break...and quick walk to the sea wall to look at the tide, not quite high yet another metre to go.
Old Lookout	10 Jul 2015	17.30	East	Sea	mid blue green grey with channel mud brown		40% grey	Sky	soft warm grey	10% grey	
Old Lookout	10 Jul 2015	17.40	East	Sea	mid blue grey with channel mud brown		40% grey	Sky	soft warm grey with lilac	10% grey	
Old Lookout	10 Jul 2015	17.50	East	Sea	mid blue grey with channel mud brown		darkening 45% grey	Sky	soft warm grey with lilac	10% grey	
Old Lookout	10 Jul 2015	18.00	East	Sea	steely blue grey patches with channel mud brown		darkening at the horizon 45% grey	Sky	soft warm grey with lilac	darkening 15% grey	waves are starting to splash up over the sea wall, the day trippers are excited running back and forth.
Old Lookout	10 Jul 2015	18.10	East	Sea	channel mud brown with steely blue		darkening at the horizon 45% grey	Sky	soft warm grey with lilac	darkening 15% grey	its family home time, all the kids are being into cars and being replace by tradesmen vans arriving for Friday night beers on the esplanade

Figure 5.5: Detail of the completed Subjective Colour Swatch spreadsheet (2015), Michaela French, The Old Lookout Studio, Broadstairs UK.

light as subject and focus of attention. I used the data sets as the basis of four short films; *Frame*, *Sea*, *Sky* and *Rhythm*, which were exhibited as a small-scale projection installation. *Frame* (Figure 5.6, p. 139) used the time-lapse sequences to examine light as a temporal material. *Rhythm* used the numeric data sets to examine the rhythm of light as information. *Sea* and *Sky* used the Subjective Colour Swatches to re-examine the light data in a time-based medium.

Working with the theme of repetitive cycles of change, I created a light archive, *Specimen Drawer Sky and Sea* using a reclaimed wooden index drawer (Figure 5.7, p. 139). Two gridded fields of light transmitting optic fibres were enclosed inside the drawers. Using the Subjective Colour Swatch data set, the light of the sea was archived in one drawer, and the light of the sky was archived in the other.

The final artwork I created was an adaptation of the Subjective Colour Swatch data set, in the form of two large format prints, *Light Collection Sample* (2015) (Figure 5.8, p. 140). The image consisted of two horizontal rows of colour swatches in a landscape orientation. The first image included only the colour swatches I had observed; the second print was framed with black at either edge to reflect a full 24-hour diurnal cycle (Figure 5.9, p. 140). The findings, implications and significance of this practice-based artistic observation of light are presented and discussed below.

### 5.3 The Old Lookout - Findings

In this section I present the findings from *The Old Lookout* project using the evaluation criteria specified in Section 3.6 (p. 99). These findings are examined and expanded in further detail in the discussion that follows.

#### Attunement to Light

01. The immersive ten-day residency led by the rhythm of light and dark was conducive to educating attention through the observation of light. During this project, I became increasingly aware of subtle shifts in the colour and quality of light as I attuned to the diurnal light cycle.
02. Light was experienced as a unified expansive field. My conscious understanding of being immersed in the light was refined through the repetitive process of attentive observation. Attunement to light as an expansive ecological field was amplified by the Ecological Lens experiment *There is No Membrane*.

#### Emergent Patterns

03. Patterns of change over time emerged as significant in articulating levels of ecological interrelation inherent in the artistic observation of light. These included the changing role of the artist-researcher, the development of my perceptual awareness, and the cyclic rhythm of diurnal change.

#### Unconventional Affordances

04. I am a light sensor. My perceptual system was shown to be a flexible, adaptable and reliable light sensor, which was effectively employed to generate beautiful data.
05. The artistic observation of light led to a subjective, but rigorous and repeatable, technique for observing and recording light data. The Subjective Colour Swatch technique contributed to an expanded understanding of the ecological interrelation between light and perceiver, and in doing so facilitated an education of attention.
06. Expanding Gibson's idea of perceiver-environment mutuality,<sup>524</sup> the concept of the light-perceiver-environment nexus (Section vi, p. 25) was developed to articulate the systemic ecological interrelation experienced in the process of the attentive observation of light.

## 5.4 Discussion: A New Level of Description

### 5.4.1 Addressing the Research Questions

*The Old Lookout* project pre-dated the Gibsonian research framework proposed in this thesis; however, it was governed by the six methodological principles outlined in Section 3.3 (p. 93-95). *The Old Lookout* investigation examined whether an education of attention might be facilitated through the attentive observation of light using Gibson's theory as a conceptual foundation. The project addressed my research questions in two main ways.

1. Which principles and concepts from Gibson's ecological approach to visual perception might be adapted and applied to frame ecological artistic research that facilitates an education of attention through the rigorous observation of light?

In response to my first question the six methodological principles selected from Gibson's theory (Section 3.3, p. 93-95) were applied and tested through practice-based artistic enquiry to determine whether it might be successfully adapted as a research framework.

2. What practice-based methods emerging from a Gibsonian research framework might be applied through artistic practice to cultivate an ecological worldview?

.....  
524 Gibson, 1979, p. 8.

In response to my second research question, a range of light recording techniques were tested to refine the Durational Observation method and to examine the concepts of the ambient optic array and light as information. The Ecological Lens method was applied to examine Gibson's ecological concepts of mutuality and reciprocity through the observation of light. The Reflective Artistic Practice method was applied to create artworks which elucidated the ecological interrelation inherent in the practice-based observation of light. Each of these methods contributes to the development of an ecological worldview which I discuss in the following sections.

#### 5.4.2 Learning to See - An Ecological Attunement

*The Old Lookout* residency was highly conducive to educating attention through the observation of light (Finding 01). From sunrise at 4.55am until sunset at 10.30pm, the experience of being in light, looking at light and perceiving light was the focus of my attention. Over the ten days of the project my patterns of waking and sleeping synchronised to the diurnal rhythm of light and dark and I became acutely aware of the flow of changing light in the studio. As my perceptual system attuned to the light, I became increasingly aware of my own process of seeing. Gibson's premise that perceptual information about the environment and the self are inseparable<sup>525</sup> was mirrored in my observation process. I understood intellectually and experientially that 'it is ourself whom we study in studying light'.<sup>526</sup>

In *Ways of Seeing*,<sup>527</sup> John Berger proposed that 'the way we see things is affected by what we know, or what we believe'.<sup>528</sup> Conversely, in Gibson's model of direct perception what we know and how we conceive the world is determined by how and what we see. To examine this conundrum and my own process of seeing, I compared my visual capacity to the other two recording techniques I trialed in *The Old Lookout* enquiry. In comparing my visual capacity to my digital counterparts, the digital light sensor and camera, I found I was able to register a broader range of luminance: I could observe detail in light information in peak and low light conditions that the digital systems could no longer detect. I had the capacity to focus on a single point of interest, whilst simultaneously experiencing light as an expansive unified field (Finding 02), whereas the digital devices could record only one form of information. My perceptual system was responsive and expansive, capable of gathering supplementary environmental and experiential information in support of the light data I collected.

This corresponded with Gibson's proposition of a unified, overlapping perceptual system,<sup>529</sup> which Joseph D. Anderson suggests (Section 2.4.5, p. 67) can facilitate

525 Gibson, 1979, p. 126.

526 Review of 'Catching the Light', by Arthur Zajonc, *Kirkus Reviews*, November (1992) <<https://www.kirkusreviews.com/book-reviews/arthur-zajonc/catching-the-light/>> [accessed 3 October 2017].

527 John Berger et al., *Ways of Seeing* (London: British Broadcasting Corporation: Penguin Books, 1973), p. 8.

528 Ibid.

529 Gibson, 1979, p. 244.; Gibson, 1966.

a 'process of information comparison'<sup>530</sup> when working across 'two or more sensory modes simultaneously'.<sup>531</sup> Through 'cross-modal confirmation'<sup>532</sup> the veridicality of information and perceptual experience are confirmed. *The Old Lookout* project showed my perceptual system to be a highly evolved, flexible, adaptable and reliable data collection system. My subjective observations generated data that was both relevant and appropriate to this ecological research (Finding 06).

Art historian Ernst Gombrich suggested that Gibson's ecological paradigm invites us 'to unlearn',<sup>533</sup> to overcome cultural thinking that has taught us 'to distrust our senses and [...] look down on those who confuse their subjective experiences with objective facts'.<sup>534</sup> When commencing this project, I considered digital technologies to be more accurate and reliable data-gathering techniques than my own subjective capabilities. *The Old Lookout* experience forced me to re-examine my relationship with my perceptual system and I found a deep respect for its capacity to capture data. I became a light sensor and my artist-researcher role expanded again (Finding 04).

This renewed way of seeing, my trust in my subjective perceptual capacity and my growing attunement to light (Finding 01) offered evidence that the Durational Observation method was well suited to an ecological research investigation, and that an education of attention could be facilitated through the attentive observation of light.

#### 5.4.3 There is No Membrane

The Ecological Lens method was also instrumental in facilitating new perspectives in *The Old Lookout* project. The Membrane is Permeable lens established the permeability between light and body in *A Year of Light*. Building on this, the second lens, There is No Membrane proposed that the conceived boundaries between the self and the world did not exist. Visual experience is comprised of three conceived territories: the self, or 'internal mental world',<sup>535</sup> the environment defined as 'here',<sup>536</sup> and the environment defined as 'out there'.<sup>537</sup> Cyberneticist Gregory Bateson proposed that the conceived division between the 'internal mental world' and the 'external physical world' was based on differences in the coding and transmission of information inside and outside the body – 'the world of information processing is not limited by the skin'.<sup>538</sup> The flow of information between 'self' and 'here' is continuous. Gibson contended that the conceived division between 'here' and 'out there' is derived from 'the occluding boundary of the

530 Anderson, 1996, p. 82.

531 Ibid.

532 Ibid.

533 Gombrich, 1989, p.13.

534 Ibid.

535 Bateson, 1972, p. 460.

536 Gibson, 1979, p. 207.

537 Ibid.

538 Bateson, 1972, p 460.

[perceiver's] field of view'.<sup>539</sup> In the perception of the self, 'here' and 'out there' are inseparable and reflective of the physiological limits of the perceptual system.

Embedded in the durational observation process, *There is No Membrane* served as a wrecking ball which actively demolished these conceptual edifices. In the immersive process of attentive observation in the Old Lookout studio, focused on the fluctuating field of the ambient optic array, this Ecological Lens set me adrift in what Gibson described as a 'reverberating flux of light',<sup>540</sup> in which self, here, and out there coalesced in a unified continuum (Finding 02). Light appeared to flow freely back and forth across these territories. Whilst light remained my focus of attention, the boundary between myself and the environment was no longer 'fixed at the surface of the skin'.<sup>541</sup> Through repeated, focused observation in the immersive perceptual ecology of the Old Lookout studio my experience of light was altered.

An education of attention can take different forms. *There is No Membrane* was a re-education which revealed discrepancies between experiential and intellectual knowing. In re-imagining the conceptual boundaries inherent in the artistic observation of light, Gibson's concepts of reciprocity and perceiver-environment mutuality<sup>542</sup> were integrated into my artistic research process. Responding to this new understanding, I devised the concept of the light-perceiver-environment nexus<sup>543</sup> (Finding 06) to articulate the ecological interrelation inherent in the attentive observation of light.

The Ecological Lens method was shown to effectively integrate Gibson's theory into the practice-based artistic observation of light. In undertaking this project framed by Gibson's paradigm it became apparent that my existing worldview would have to be relinquished<sup>544</sup> if I were to adopt a fully ecological perspective.

#### 5.4.4 Uncovering Patterns of Change Over Time

On completion of *The Old Lookout* residency, I used the Reflective Artistic Practice method to create a series of artworks based on the visual data sets collected on location. From the three sets of light data one dominant theme emerged: patterns of change over time (Finding 03). In an ecological context a pattern (Section 3.3, p. 93-95) can be understood as recurring information or a behaviour which becomes evident and observable through repetition. Patterns of change were apparent in many aspects of my

539 Gibson, 1979, p. 207.

540 Gibson, 1979, p. 18.

541 Patrizio, 2019, p. 36.

542 Gibson, 1979, p. 8.

543 The light-perceiver-environment nexus (see Finding 06) builds on two ideas Gibson proposes. First, he states the 'animal and environment make an inseparable pair' (Gibson, 1979, p. 8.) which he describes as a 'mutuality'. (Ibid.) Second, he defines the environment as the triad of medium, substances, and surfaces (Ibid., p. 22.) and goes on to suggest that this description, 'to be complete, should include the reverberating flux of light in the medium', (Ibid., pp. 22-23.) The neologism of the light-perceiver-environment nexus was devised to explicate this ecological interrelation (See Section vi: Definition of Terms, p. 25).

544 As discussed, Edward Reed (Section 2.3.5, p. 49) forewarned of this eventuality (1988, p. 319.) and Andrew Patrizio (Section 2.4.8, p. 77) suggests that 'thinking ecologically carries with it a large measure of responsibility' (2019, p. 65). Adopting an ecological worldview has presented multiple professional, personal and artistic challenges throughout this research process.



Figure 5.6: *Frame* (2015), Michaela French 'The Motion of Matter', Bow Arts Project Space, London.

Figure 5.7: *Specimen Drawer Sky and Sea* (2015) Michaela French, 'The Motion of Matter', Bow Arts Project Space, London.



Figure 5.8: *Daylight Observations: The Old Lookout* (2015) Michaela French, 'The Motion of Matter', Bow Arts Project Space, London.

Figure 5.9: *Daylight Observations: The Old Lookout: 24 hour* (2015), Michaela French, 'The Observer Effect' Hockney Gallery, Royal College of Art, London.

enquiry: fluctuations in the light I observed were tied to patterns of change in the local environment, influenced by diurnal cycles and the earth's orbit around the sun. Changes in my attunement to light and perceptual awareness broke established patterns of seeing and thinking, altering my role of artist-researcher. As with the previous project, the idea of a small repetitive action contributing to a larger ecological pattern was also evident here. *The Old Lookout* project reflected a symmetry of scale in which pattern and light were present at every level.

Patterns of change were a visual priority in creating the artworks I developed in this project. The relationship between light, time and change was explored in different ways in the short films *Frame*, *Sea*, *Sky* and *Rhythm* (2015); the light archive, *Specimen Drawer Sky and Sea* (2015); and two large format prints, *Light Collection Samples* (2015). Working with the three data sets, I anticipated that the progressive changes in light I had observed in *The Old Lookout* project would be best represented using time and light-based media. This proved not to be the case. In the short films *Sea* and *Sky* and *Specimen Drawer Sky and Sea* which used the Subjective Colour Swatch data set (Finding 05), the transition of light from one colour blending into the next did not afford a comparative overview, and therefore the larger ecological perspective evident in the data set remained hidden in the artworks. The short time-lapse film *Frame* became a study of light and space rather than explicating the patterns of change in the light-perceiver-environment nexus (Finding 06).

Unlike the films, the *Light Collection Sample* prints reflected the incremental changes in light and the progression of time in a single comparative view. They captured the idea of repetition, the process of looking, fluctuations in light and patterns of change over time. Each light sample in the print contributed to the whole, and the completed image was itself a small reflection of a larger ecological pattern of change. To effectively reveal these temporal and cumulative patterns in the artworks required comparison. When the data was reinterpreted using the media of light and time, the patterns of light and time were rendered invisible. When the medium was neither temporal nor light-based the rhythms, fluctuations and patterns inherent in the light-perceiver-environment nexus became the focus of attention.

Using this artistic practice to reflect on the three techniques I had tested for recording observational light data in *The Old Lookout* project, it was clear that the process of direct observation combined with the Subjective Colour Swatch technique (Finding 05) was the most effective in facilitating an education of attention through the attentive observation of light (RQ2). As Gibson proposed, direct perception proved to be 'the simplest and best kind of knowing'.<sup>545</sup> Framed by Gibson's ecological principles, *The Old Lookout* investigation itself became an education of attention as the Durational Observation, Ecological Lens and Reflective Artistic Practice methods effectively facilitated attunement to light through the practice of attentive observation.

.....  
545 Gibson, 1979, p. 263.

## 5.5 The Old Lookout - Summary

*The Old Lookout* project used the observation of light as a catalyst for attunement, for artistic enquiry, for expanding perceptual awareness, and to facilitate an education of attention based on the six Gibsonian principles (Section 3.3, p. 93) and Gibson's concepts of the ambient optic array, light as information, reciprocity and mutuality. The findings, data sets, artworks and perceptual changes discussed in this chapter provide evidence that a framework for ecological artistic research based on Gibson's principles can facilitate an education of attention through the attentive observation of light.

This intensive study of light taught me to trust and value my subjective perceptual experience and broadened my understanding of what artistic research could be. The Subjective Colour Swatch technique (Finding 05) for recording observed light data was developed through exploratory artistic enquiry and the concept of the light-perceiver-environment nexus (Finding 05) was defined to explicate the systemically entwined interrelation between light and perceiver.

*The Old Lookout* project showed that the attentive observation of light leads to attunement, which can, in turn, facilitate an education of attention. Educating attention through repetitive practice enables improved awareness in the perceptual system.<sup>1546</sup> *The Old Lookout* project was an education of attention in an immersive field of light, in which, guided by Gibson's principles, I began learning to see ecologically. This serves as the starting point for my third artistic research project, *Daylight Observations* (2015), which I discuss in the following chapter.

## Chapter Six: Project Three

# Daylight Observations

.....  
546 Ibid., p. 254.



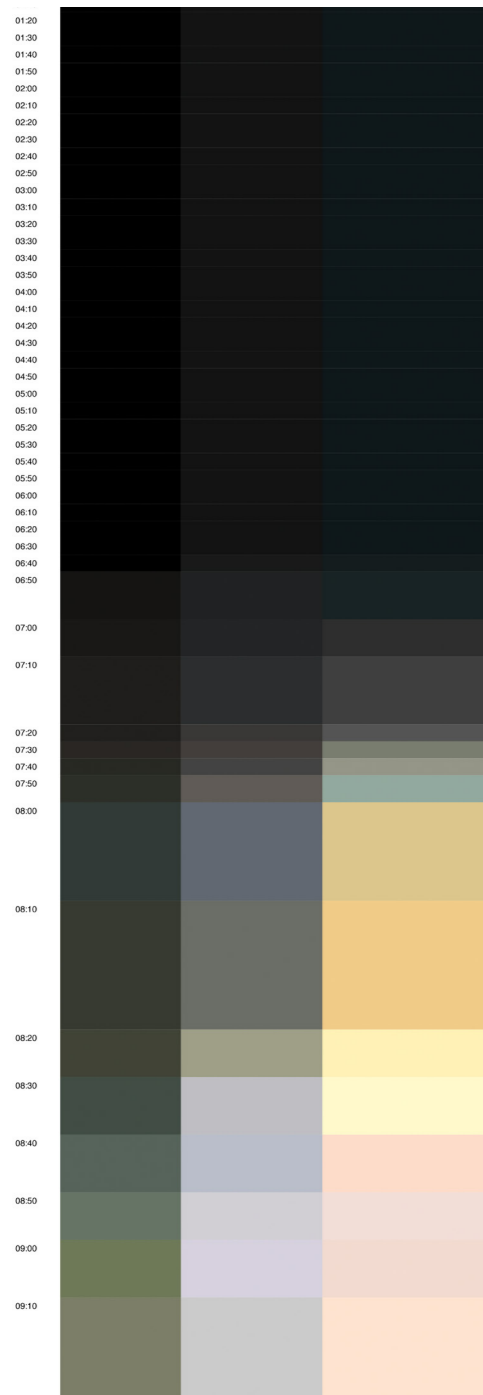

Figure 6.1: Subjective Colour Swatch spreadsheet (detail), *Daylight Observations* study, 21st December (2015), Michaela French.



Figure 6.2: Sunrise, *Daylight Observations* study, 21st December (2015), Michaela French.

## 6.1 Daylight Observations - Introduction

The emerging findings from *The Old Lookout* and *A Year of Light* projects suggested that a cohesive research framework based on Gibson's ecological theory could offer a suitable methodology for ecological artistic research based in the attentive observation of light. On this basis, and prior to commencing the *Daylight Observations* project, I defined the Gibsonian framework and methodology for ecological artistic research presented in Chapter Three (Section 3.4, p. 96).

*Daylight Observations* was the first artistic research project to adhere strictly to the Gibsonian research framework. The six defining Gibsonian principles (Section 3.3 p. 93) served as the methodological foundation, and the five stages of the research framework in Table 6.1 (below) provided the structure for the practice-based artistic enquiry.

### Five Stages of the Gibsonian Research Framework

01: Light as Information (Ecological Information)	Conceptualisation
02: A Perceptual Ecology (Ecological Knowing)	Planning
03: Attentive Observation	Execution
04: Ecological Pattern	Evaluation
05: A New Level of Description	Reconceptualisation

Table 6.1: The Five Stages of the Gibsonian Framework for Ecological Artistic Research (2019), Michaela French.

The year-long *Daylight Observations* investigation served as a site to examine how Gibson's principles might facilitate an education of attention and cultivate an ecological worldview through the observation of light when applied as methodology for practice-based ecological artistic research in response to my research questions:

1. Which principles and concepts from Gibson's ecological approach to visual perception might be adapted and applied to frame ecological artistic research that facilitates an education of attention through the rigorous observation of light?
2. What practice-based methods emerging from a Gibsonian research framework might be applied through artistic practice to cultivate an ecological worldview?

The artistic enquiry undertaken in the *Daylight Observations* project aimed to test

whether the Gibsonian ecological methodology would provide a viable framework for rigorous real-world experiential practice-based artistic investigation situated in the light-perceiver-environment nexus.

## 6.2 Description of the Artistic Research Process

### 6.2.1 Setting the Intention

The *Daylight Observations* project built on themes and findings from the previous artistic research projects. The year-long duration of the *A Year of Light* project was influential in revealing and altering established modes of perception and thinking. To explore this dynamic further, I undertook *Daylight Observations* over a twelve-month period. The idea of a small repetitive action contributing to a larger structure over time also informed the *Daylight Observations* investigation. The observations took place on the 21st day<sup>547</sup> of each month from December 2015 to December 2016. On each of these thirteen days I observed fluctuations in daylight in a selected location, recording a light sample every ten minutes across the day.

The primary purpose of this project was to address the research questions as discussed above. However, *Daylight Observations* had two additional aims: as with the previous artistic research projects, the artistic intention was to examine and elucidate the systemically entwined interrelation between light and perceiver. Following *The Old Lookout* project, I sought to continue expanding my capacity for 'ecological seeing' by educating my perceptual awareness through attentive observation.

### 6.2.2 Stage 01: Light as Information

This stage of the Gibsonian enquiry is governed by the first of the six principles (Section 3.3, p. 93), which states that light not only provides information about an environment: but can itself be information. *Daylight Observations* focused on the fluctuating light in the field of the ambient optic array. In defining the specific light information to be collected as data, the variations in hue, saturation and luminance at 'the point of observation'<sup>548</sup> provided the visual information that comprised each light data sample.

The investigation was undertaken through direct visual perception and I adopted the dual role of artist-researcher and light sensor. Light was conceived as an ecological phenomenon, which afforded both visual and non-visual information, serving as a catalyst for expanding perceptual awareness in this year-long investigation.

### 6.2.3 Stage 02: A Perceptual Ecology

The second defining Gibsonian principle (Section 3.3, p. 93) articulates a perceptual

.....

<sup>547</sup> Rather using the calendar year, the *Daylight Observations* project began and ended on the winter solstice, the shortest day of the year; it also coincided with the summer solstice and the spring and autumn equinoxes. These days marked the points of maximum and minimum light during the year. Capturing the longest and shortest days ensured the broadest range of information, and these variations were important visual references in the data set.

<sup>548</sup> Gibson, 1979, p. 51.

ecology in which the perception of light, the environment and the self are bound within an inseparable, dynamic system of exchange.<sup>549</sup> This premise framed the second stage of my enquiry, in which the scope of the project was defined. This artistic research project was situated in the light-perceiver-environment nexus; light was considered ecological and the environment holistic, and in this context direct perception was the basis of new knowledge.

The three research methods developed in the previous projects and defined in Section 3.5 (p. 97) were applied in the *Daylight Observations* project. Durational Observation, Ecological Lens and Reflective Artistic Practice were governed by Gibson's principles of direct perception, mutuality and ecological reciprocity.

### Durational Observation

Durational Observation is the primary data-gathering method in this project. It responds to both research questions by adapting and applying Gibson's ecological principles using practice-based research methods to test Gibson's theory through artistic enquiry. Durational Observation was applied through the attentive observation of light using direct visual perception to observe fluctuations and variations in light in a specified location. The light data was recorded using the Subjective Colour Swatch technique established in *The Old Lookout* project. I recorded additional environmental information and my details of my experience to reflect my broader research ecology.<sup>550</sup>

### Ecological Lens

As with the previous projects, the Ecological Lens method was embedded into the durational observation process of the *Daylight Observations* project. The third ecological lens, Three Black Squares, invited a renewed examination of the mindset that framed my conception of light and sought to cultivate new ecological perspectives through an education of attention by bringing awareness to established limits of thinking and seeing. The Ecological Lens method responded to the second research question by providing alternate ecological perspectives within the artistic research process. The visual data sets emerging from the durational observation process combined with the renewed thinking from the Ecological Lens experiment provided the raw material for reflective artistic research phase of the project.

### Reflective Artistic Practice

The Reflective Artistic Practice method combined comparative study, pattern recognition, and reflective analysis to examine and elucidate the systemically entwined interrelation between light and perceiver. Working with the data sets from the durational

.....

<sup>549</sup> Ibid., pp. 8, 126.; Braund, 2008, 123–44.; Zahoric and Jenison, 1998, pp.78–89.; Reed, 1988.

<sup>550</sup> In defining the additional environmental and experience data I recorded, I drew on Steer's idea of selecting specific variants to construct a picture of a place (Section 2.4.4). Three themes determined the information I recorded: 1. Factors that directly influenced the quality or amount of light observed primarily this was related weather. 2. Change or variation in my process of seeing and perceptual awareness. 3. Emergent patterns or observable interconnections: these could be either environmental, perceptual or behavioural.

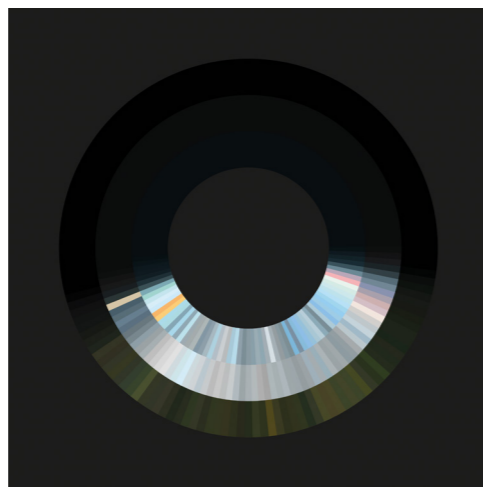

Figure 6.3: *Et sic in infinitum* (And so on to Infinity) (1617-1618), Robert Fludd, (*Utriusque cosmi maioris...*, Page 26)  
Credit: Wellcome Collection.

Figure 6.4: *Hubble Ultra Deep Field* (2014), NASA and ESA, (Baltimore: NASA Hubble Space Telescope, 2014)

Figure 6.5: *Orbit No.12 - 21st November 2016, Latitude: 51° 45' 41" N, Longitude: 0° 00' 41" W, Location: Hoddesdon, Hertfordshire, UK, Direction of View: 96 E* (2016), Michaela French.

observation process, the Reflective Artistic Practice enquiry drew out inherent ecological patterns that emerged across multiple levels of my project. The artworks produced using this method reflected the new knowledge and ecological experience generated in my attentive observation of light.

The evaluation criteria for *Daylight Observations* corresponded with the specification in Section 3.6 (p. 99): attunement to light, emergent patterns and unconventional affordances.

#### 6.2.4 Stage 03: Attentive Observation (Data Collection)

The third stage of this research project applied Gibson's principle of attentive observation through artistic practice. Working from the premise that the perceptual system is 'susceptible to maturation and learning',<sup>551</sup> the observation of light is used in this project to facilitate increased perceptual awareness to expand the quality and variety of information available.

*Daylight Observations* began before dawn on December 21st, 2015. It was the shortest day of the year. From sunrise at 08:03:28 to sunset at 15:53:23.<sup>552</sup> I recorded 68 light samples into a Subjective Colour Swatch spreadsheet (Figure 6.1, p. 144). This first observation took place in Hertfordshire, England, where my home affords a long view to the far south-east horizon (Figure 6.2, p. 144). I selected an area between two stands of trees, where I specified three adjacent collection points: the ground at the horizon, the sky at the horizon and the sky at 15° above the horizon.<sup>553</sup> I collected data from both the ground and sky to capture the structural variations in light that Gibson specified:

In the case of ambient light that is unstructured in one part and structured in an adjacent part, such as the blue sky above the horizon and the textured region below it, the former specifies a void and the latter a surface<sup>554</sup>

The changing light of void and surface was collected, three cells of colour at a time, every ten minutes from before dawn until darkness fell. All but two of the daylight observations took place in the same Hertfordshire location. In February 2015, light was observed from a north-facing window of an eighth-floor apartment near Alexanderplatz in Berlin. In June 2015, an east-facing hotel window in Columbus, Ohio, USA provided my observation point. This change of location caused inconsistency in the data, but it was interesting to see the quality of light in each location reflected in the data sets.

.....  
551 Gibson, 1979, p. 245.

552 The information for all sunrise and sunset times during the *Daylight Observations* project was drawn from 'Sunrise & Sunset Times', UK Weathercams <<https://www.ukweathercams.co.uk/>>[accessed December 2015 - December 2016].

553 The decision to add this additional colour swatch occurred during the first daylight observation on 21st December 2015, because there was a consistent and significant variation in the light visible in the sky at these two positions.

554 Gibson, 1979, p. 52.

Over the year, the thirteen data collection days followed the same process: the daylight observation began and ended in the dark, and incremental data samples recorded the changing light over each day using the Durational Observation method. The thirteen visual data sets produced were a record of my year of observing light and simultaneously a record of the annual orbit of the earth around the sun.

The ecological lens Three Black Squares was embedded into the durational observation process over the year. Three Black Squares built on the two ecological lens experiments that had been applied in the previous projects. The third lens, Three Black Squares, invited an examination of the implicit worldview which defined my interrelation with light and began with a comparative study of two images.

*Et sic in infinitum* (And so on to Infinity), from Robert Fludd's book *Utriusque Cosmi* (1617-21) (Figure 6.3, p. 148)<sup>555</sup> is a small black print that depicted the 'black void prior to the light of creation'.<sup>556</sup> *Hubble Ultra Deep Field* (2014) (Figure 6.4, p. 148),<sup>557</sup> by NASA and ESA,<sup>558</sup> also depicted a void of space that appeared empty to the unaided human eye. From 2002 to 2012 the Hubble telescope recorded light observations in an area of black space in the constellation Fornax. The light data collected over 841 orbits ranged from ultraviolet to infrared and was composited to reveal over 10,000 previously unseen galaxies.

The juxtaposition of these two images showed a continuity in the representation of the black void but reflected vastly different cultural perspectives, in which the power of the worldview in defining and limiting what we see is highlighted. The techno-cultural underpinning of the Hubble Ultra Deep Field image was beyond conception in the worldview that defined Robert Fludd's metaphysical investigation. Equally, Fludd's notion of the light-filled universe as inseparably entwined with the Divine appears naive from this perspective.

Applying the Three Black Squares lens, I attempted to envisage a third black square which would reflect an analogous leap in human evolution 397 years into the future. The Three Black Squares experiment was unanswerable: any cultural cosmology I might imagine for the year 2417<sup>559</sup> was limited by my twenty-first century field of view. However, the experiment provoked an in-depth examination of how my seeing, thinking and worldview are framed. To acknowledge the limits of my own view I appended a third black square derived from my own observation of light and dark (Figure 6.5, p. 148).

.....  
555 Fludd, 1617.

556 Benson, Michael, *Cosmographics: Picturing Space Through Time*, (New York, NY: Abrams, 2014), p.19.

557 At the time of its publication *Hubble Ultra Deep Field 2014* image was accepted as the deepest view of the universe. ('Deep Fields' *Hubblesite*, <<http://hubblesite.org/image/3380/news/14-deep-fields>> [accessed 22 March 2017].

558 *Hubble Ultra Deep Field 2014*, NASA, ESA, H. Teplitz and M. Rafelski (IPAC/Caltech), A. Koekemoer (STScI), R. Windhorst (Arizona State University), and Z. Levay (STScI), <<https://hubblesite.org/image/3380/gallery/58-hubble-ultra-deep-field>> [accessed 22 March 2017].

559 At the time of applying the Three Black Squares ecological lens the question of whether humanity would be in a position to create an equivalent image in 393 years was significantly less pressing than it is currently.

### 6.2.5 Stage 04: Ecological Pattern (Reflective Artistic Practice)

This fourth stage of the Gibsonian research process used the Reflective Artistic Practice to draw out emergent patterns of information and reveal systemic relationships in the light data sets and in the research process more broadly.

During the data collection stage of *Daylight Observations*, I became aware of patterns in the light samples. Each daylight observation data set recorded the light of a single day. The data reflected the quality of light in the place and time it was observed, with seasonal fluctuations revealed in evolving colour and luminance palettes. When all thirteen data sets were viewed collectively the information gathered from the ambient optic array over the year visibly revealed the tilting rotation of the earth. Sitting quietly in my attentive observation process, observing fluctuations in light, I had created a record of the earth's annual orbit around the sun, one light sample at a time. Recording light at the far edge of my view had revealed more than my eye could see. The small cumulative repetitions coalesced, offering evidence of a larger ecological system. This expanded view formed the basis of three artworks I produced using the thirteen visual data sets.

The first artwork combined all thirteen data sets in a short looping film, *Daylight Observations* (2016)<sup>560</sup>. The light samples were presented in a landscape format, surrounded by a black field to accentuate the compression and expansion of light over time. Each data set dissolved softly, one into the next, to create a continuous cyclic flow of light and dark derived from the tilting orbit of the earth in its journey around the sun.

The large format prints from *The Old Lookout* project had effectively expressed in the ecological principles that inform this research. Following this, I decided to create a series of prints using the *Daylight Observations* data sets as the starting point. The theme of patterns emerging over multiple scales was crucial; the print series should articulate a single moment of sampled light, whilst simultaneously showing the cumulative daily observations and the longer arc of the annual planetary orbit. The series should also reflect the ecological interrelation of personal and global cycles inherent in the light-perceiver-environment nexus.

My enquiry coincided with an investigation of the eye, the visual process, the conception of globes and spheres<sup>561</sup> and the metaphor of the heavenly sphere.<sup>562</sup> Working with the data sets under this spherical influence resulted in thirteen images of *The Orbit Series* (2016) (Figure 6.6, p. 152-153). In moving from a linear to a circular structure, *The Orbit Series* revealed multiple levels of interrelation in the observation of light. Each image can be understood as an iris or eye, as a record of change on a luminous day, and as a rotation of the earth on its axis (Figure 6.10, p. 161). Collectively the thirteen images spoke of the cyclic orbit of a planet in a larger universal system.

The first seven prints of *The Orbit Series* were exhibited in *Catching the Light*

.....  
560 The *Daylight Observations* film (2016) is available online at <[vimeo.com/254202520](https://vimeo.com/254202520)>

561 Tim Ingold, 'Globes and Spheres', in Ingold, 2000, pp. 209-218.

562 David McConville, 'On the Evolution of the Heavenly Spheres' (unpublished PhD Thesis, Plymouth University, 2014).

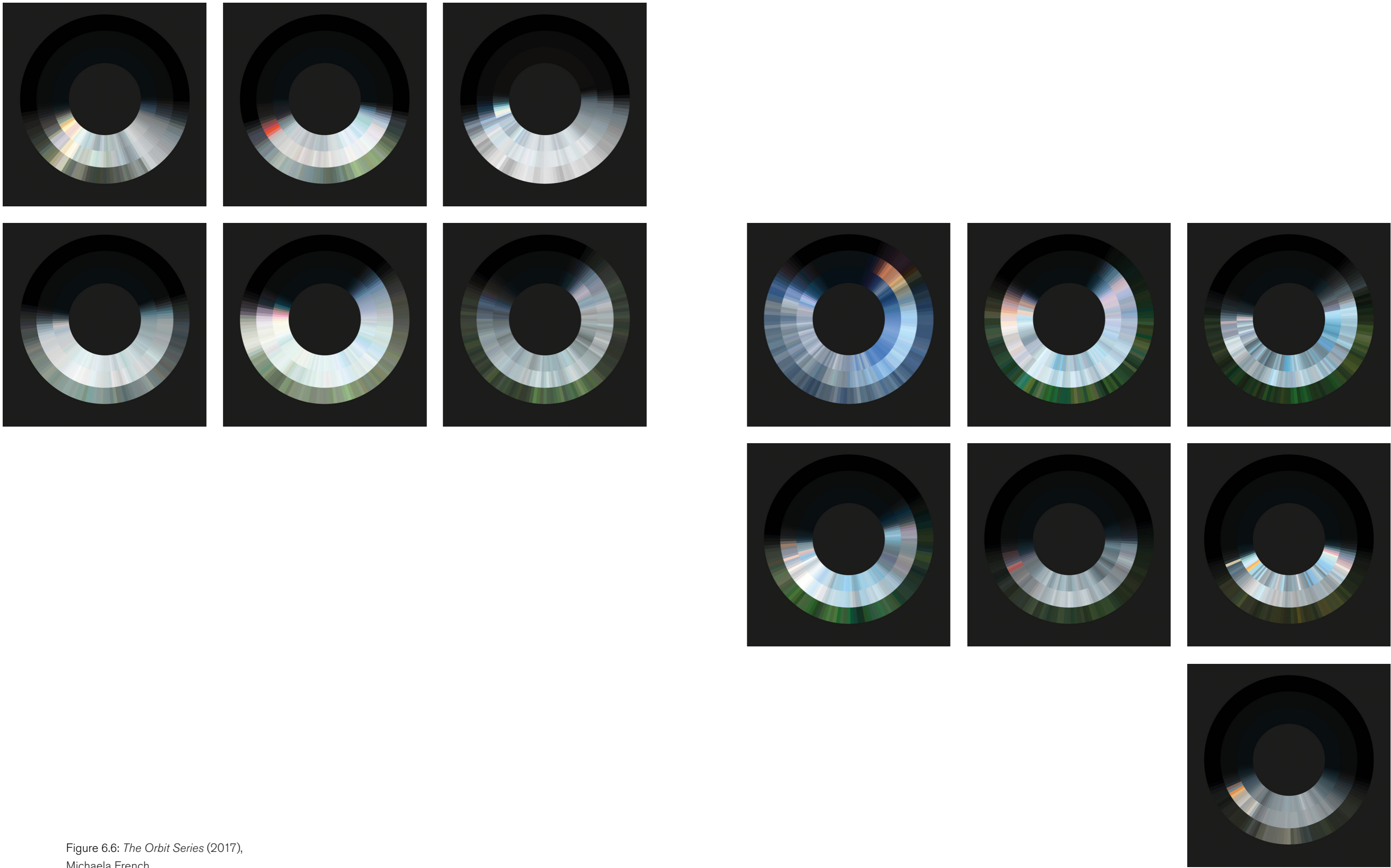

Figure 6.6: *The Orbit Series* (2017),  
Michaela French.

(2016) (Figure 6.7 and 6.8, p. 155)<sup>563</sup> and *Communicating the Intangible* (2016)<sup>564</sup> with selected artworks developed in the previous two artistic research projects. The full series of thirteen prints was exhibited in *Balance-Unbalance* (2017) (Figure 6.11, p. 164).<sup>565</sup> Presenting the works in the formal context of the gallery allowed further analysis and evaluation of my work in a new perceptual ecology.

The final *Daylight Observations* artwork was *Transmission Device No's 2 & 3 - Shortest/Longest Day Rhythm* (2016) (Figure 6.7, p. 155). This small light-based sculpture examined the interrelation of light, darkness and duration, comparing the light rhythms of the longest and shortest days of the year. Two blocks of fused optic fibre framed by small wooden boxes were illuminated by hidden LED lights. Using relative proportions of darkness, twilight and daylight hours, one device was programmed to follow the light/dark cycle of the winter solstice, 21st December 2015, the other followed the light rhythm of the summer solstice, 21st June 2016 (Figure 6.9, p. 158-159). These synchronised devices offered a visual comparison of the two extremes of the tilting earth's annual heliocentric orbit, and were also included in the *Catching the Light* (2016) exhibition.

### 6.3 Daylight Observations - Findings

In this section the findings emerging from the *Daylight Observations* investigation are identified and articulated. These findings correspond with the evaluation criteria specified in Section 3.6 (p. 99), and indicate the refinement, perceptual learning and new knowledge this project generated.

#### Attunement to Light

01. Light as information and focus of attention is inherently ecological in its consistency across all levels of observation, from personal to universal.
02. The attentive observation of light produced an effect of the compression and expansion of time. Time accelerated in the single repetitive data collection process and slowed substantially over the year-long enquiry.

#### Emergent Patterns

03. Darkness is a presence in the attentive observation of light.
04. Gibson's principles, applied as a cycle of enquiry, enabled a deeply integrated experiential and analytical engagement with the light-perceiver-environment nexus, revealing ecological interrelation across multiple levels of observation.

.....  
563 'Catching the Light', Sidney Cooper Gallery, Canterbury, UK, 2016.

564 'Communicating the Intangible: Research Work in Progress Show, London Design Week', Hockney Gallery, Royal College of Art, London, 2016.

565 Michaela French, *The Orbit Series*, 'Balance-Unbalance 2017', Ocean Studios Gallery, Plymouth Arts Centre, Plymouth UK, 2017.



Figure 6.7: *Transmission Device No. 2 and 3: Shortest Day Rhythm, Winter Equinox, 21st December 2015 and Longest Day Rhythm, Summer Equinox, 21st June 2016* (2016), Michaela French. 'Catching the Light', Sidney Cooper Gallery, Canterbury, UK.

Figure 6.8: *The Orbit Series: 1 - 7* (2016), Michaela French, 'Catching the Light', Sidney Cooper Gallery, Canterbury, UK.

### Unconventional Affordances

05. Observing light equated to observing the orbit of the earth. This experiential knowledge changed my conception of the sun rising and setting to seeing the earth moving around the sun, albeit very slowly to my eye.
06. Learning to see ecologically meant challenging the limits of my comprehension and unlearning what I thought I knew. This was an uncomfortable and humbling experience, but the value of prolonged, attentive, focused observation in educating the perceptual system was evident.

## 6.4 Discussion: A New Level of Description

### 6.4.1 An Introduction

Following Gibson's notion of a new level of description (Section 3.3, p. 93), the final stage of the Gibsonian framework for ecological artistic research is a point of culmination and reflection in the research cycle. This stage highlights the learning, insights and new knowledge emerging from the research process, and discusses the significance of the findings presented above. It also serves as a point of reconceptualisation or provocation for subsequent investigation.

This discussion examines the findings and outcomes of the *Daylight Observations* project to evidence the capacity of the Gibsonian research framework to facilitate an education of attention through the observation of light using the three practice-based research methods employed in this study.

### 6.4.2 Discovering Ecological Light

The attentive observation of light was the foundation of the *Daylight Observations* project. The simple repetitive act of observing and recording fluctuations in light at ten-minute intervals one day a month substantially altered my perceptual awareness and ecological perspective. These changes in perception enabled a new conception and experience of my environment that allowed new knowledge to emerge.

One significant change emerging from this enquiry was my understanding of light as inherently ecological (Finding 01). Light was information and the focus of attention; light was also the means by which the observations were undertaken. This self-referential loop connected my eye outward into the vast expanse of space. The ability of light to traverse and permeate boundaries between internal and external, local and global, personal and universal, indicates its ecological capacity 'to be one and many, particle and wave, a single thing with the universe inside'.<sup>566</sup> The data sets produced in *Daylight Observations* reflect this interrelation between personal experience and the universal system. Each light sample derives from an individual perceptual action which, when repeated over time, collectively revealed patterns of the earth's rotation, orbit and systemic interconnection.

566 Zajonc, 1995, p. 299.

The act of observing light was simple, but articulating the experiential interrelation with this ecological phenomenon was challenging. Situated within the Gibsonian research framework, the Reflective Artistic Practice method allowed me to explore multiple layers of ecological pattern across personal and universal scales within my artistic enquiry. Drawing out multiple layers of information from the visual data sets in the three artworks *The Orbit Series*, *Daylight Observations* film and *Transmission Devices No's 2 & 3*, I alluded to the ecological nature of light and encompassed the various spatial and temporal scales inherent in the light-perceiver-environment nexus.

### 6.4.3 Light, Duration and Time

The interrelation between light, duration and time was a consistent theme in *Daylight Observations*. The observation process, the data sets and the artworks all corresponded to Gibson's ecological proposition that visual perception was 'an exploration in time'.<sup>567</sup> As my attunement to light grew more refined through attentive observation I became aware of multiple concurrent time scales (Finding 02). In the small repeated action of observing the light samples, each ten-minute interval spent specifying the hue, saturation and luminance was over very quickly: the data was barely recorded before the next cycle began. In these moments time accelerated as each observation whizzed by. Conversely, the cumulative process of repetitive observations over the day produced the experience of time slowing down.<sup>568</sup> This feeling of slow time was compounded in the temporal experience of the year-long observation.

In the *Daylight Observations* data sets the individual light samples were extracted as discrete moments in time. Gibson argued that the attempt to separate time into 'discrete moments is misleading, even nonsensical'.<sup>569</sup> Whilst the cumulative light samples in the *Daylight Observations* film and *The Orbit Series* prints do not reflect a continuous perceptual process, they afford an alternative ecological view. From individual moments of looking to annual global cycles these multiple temporal scales correspond with the spatial boundaries of the self, 'here' and 'out there'<sup>570</sup> discussed in *The Old Lookout* project (Figure 6.10, p. 161).

In responding to the first research question, the concepts of duration and time play a critical role in the application of Gibson's ecological theory to the practice-based observation of light. As attunement to light increases, so the perception of time evolves. Observation is not simply an act of the eye, but a process of temporal engagement and exchange with light in an environment over time.

In this study, duration and the perception of varying temporal scales impacted on the observation process and contributed to my emerging ecological worldview (Finding 06). This new understanding was evidenced in the three artworks produced in the *Daylight Observations* project. These artworks also demonstrate the value of a Gibsonian

567 James J. Gibson, 'A Theory of Direct Visual Perception' [1972], in *Vision and Mind*, ed. by Alva Noë and Evan Thompson (Cambridge, MA: MIT Press, 2002), pp. 77-89, p. 84.

568 This experience was particularly pronounced on the longest observation days in May, June and July.

569 Steer, 1989, p. 94.

570 Gibson, 1979, p. 207.

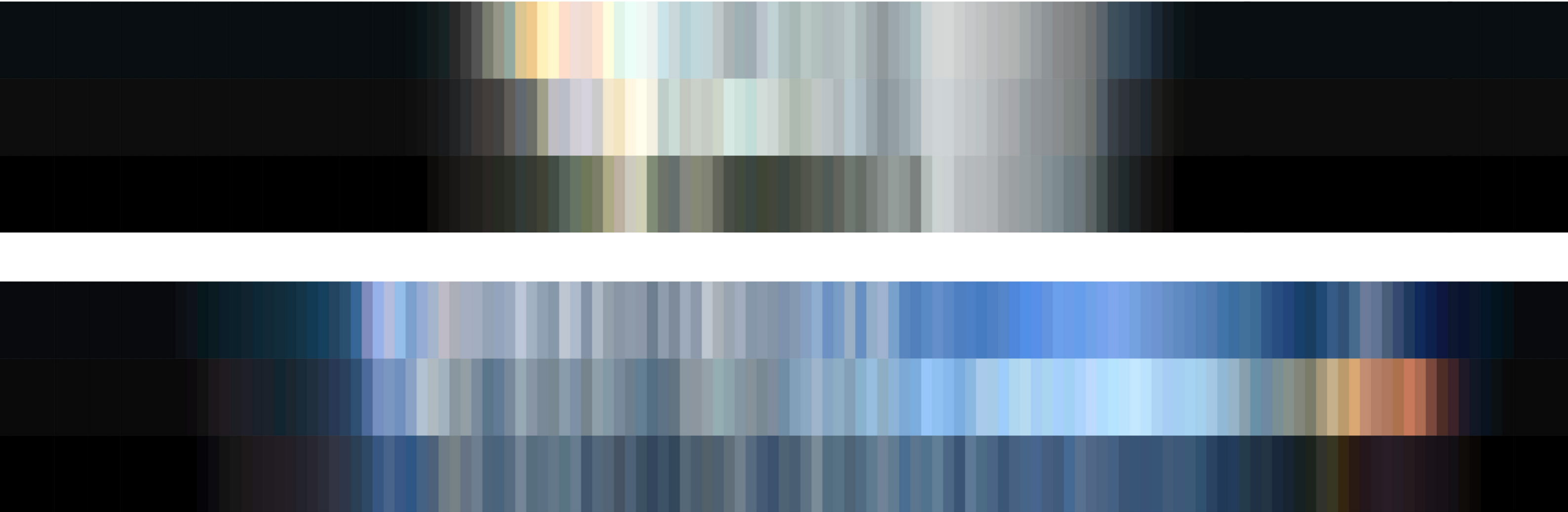

Figure 6.9: *Daylight Observations: 21st December 2015, Latitude: 51° 45' 41" N, Longitude: 0° 00' 41" W, Location: Hoddesdon, Hertfordshire, UK, Direction of View: 111 E (2016), Michaela French.*

*Daylight Observations: 21st June 2016, Latitude: : 39° 58' 14.9597" N, Longitude: 83° 0' 10.4782" W, Location: Columbus Ohio, USA, Direction of View: 81 E (2016), Michaela French.*



ecological artistic practice (Finding 04) in elucidating the systemically entwined relationships inherent in the light-perceiver-environment nexus.

#### 6.4.4 Light in Darkness

A temporal dimension can also be identified in the dialectic between light and dark.<sup>571</sup> Each observation of light in *Daylight Observations* began and ended in the dark (Finding 03). I became acutely aware of the necessity of darkness as an indicator of the edge of light, both temporally and spatially. This marked a change in my thinking and cultivated a new understanding of my observation process. In observing light, I was simultaneously observing the absence of light – darkness. In this ecological context the conceived binary of light and dark was transformed into 'an endless array of infinitesimals, not just shades of gray, between the darkness and the light'.<sup>572</sup> The light samples of *Daylight Observations* data sets are a small sample of the endless array in complementarity of light and dark.<sup>573</sup>

The merging of light and dark at the beginning and end of each of my thirteen light observations initiated another new conception of the world. As light appeared and disappeared at the horizon over three phases of twilight,<sup>574</sup> I no longer watched the sun rise and set (Finding 05); instead I observed the earth rolling away on its axis as the planet followed its orbit around a comparatively static sun. This idea was not new to me, but my way of seeing it moved toward an ecological perspective (Finding 06) which situated me, as artist-researcher and light sensor, on a planet orbiting a star in an expansive field of darkness.

This dialectic of light and dark was also inherent in the two images used in the Three Black Squares ecological lens. The persistent cultural archetype of the black void is the foundation of both these images in which light is framed by respective cultural stories of divinity and technological dominion. This universal narrative is one I encountered in my observations of light: from the black void light appears and beyond the light there is more darkness. Three Black Squares brought a new level of awareness to the influence of implicit cultural perspectives in my own observations of light, demanding that I look again, re-frame my view and see more attentively. The conceptual explorations Three Black Squares initiated were influential in the artworks produced in the *Daylight Observations* project and are evident in the sunrise-sunset example in Finding 05.

571 Cubitt, p. 267.

572 Ibid.

573 In finalising the printing technique and colour calibration for *The Orbit Series* digital prints it was the quality of the blackness, rather than the light, that demanded the most refinement and adjustment. Without a rich depth of black in the prints the impact and clarity of the light samples was significantly diminished.

574 'Types of Twilight', *Timeanddate.com*, 2016 <<https://www.timeanddate.com/astronomy/different-types-twilight.html>> [accessed December 2015 - December 2016].

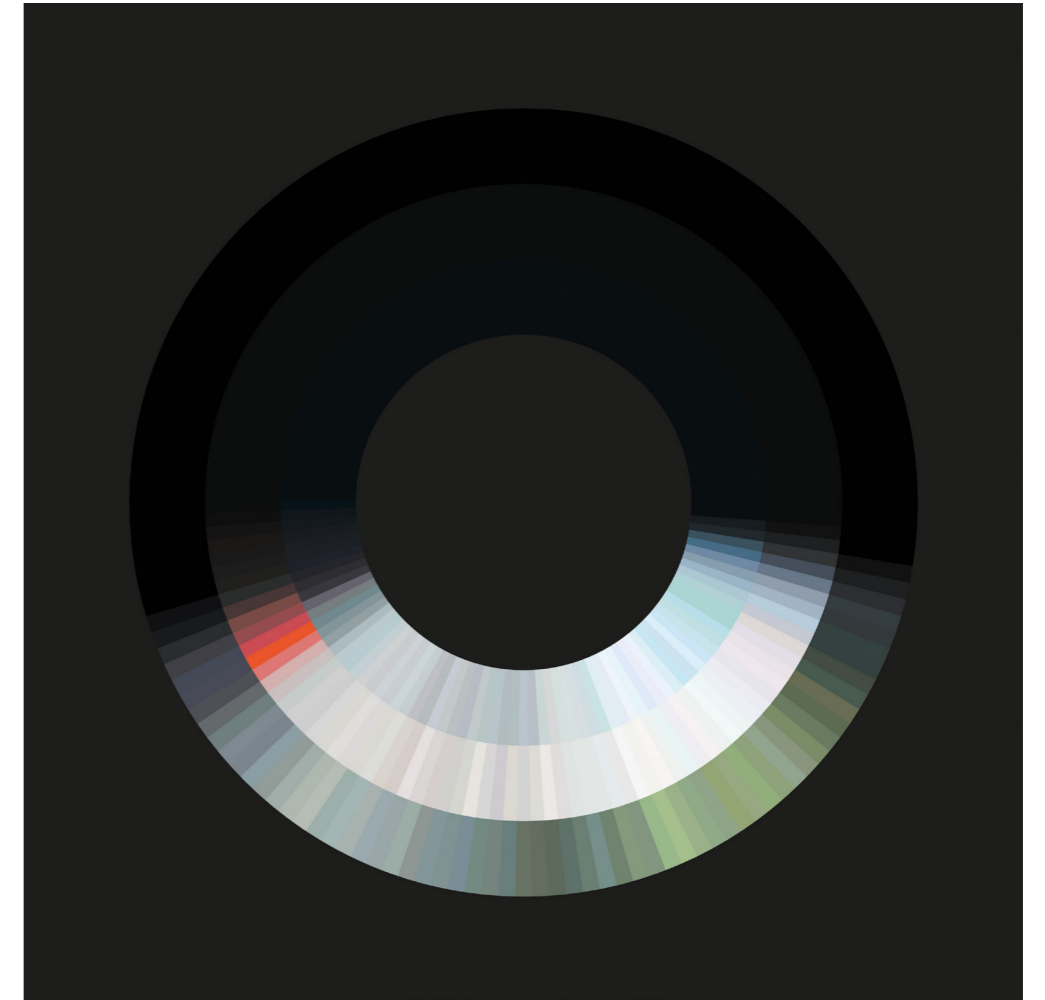

Figure 6.10: Orbit No.2 - 21st January 2016,  
Latitude: 51° 45' 41" N, Longitude: 0° 00' 41"  
W, Location: Hoddesdon, Hertfordshire,  
UK, Direction of View: 124E (2016),  
Michaela French.

### 6.4.5 An Emerging Ecological Approach

The three themes discussed here – light as inherently ecological, light and temporality and light and darkness, all emerged through the experiential practice of observing light over the year-long *Daylight Observations* enquiry. The value of prolonged attentive observation of light in generating perceptual change and new knowledge through an education of attention (Finding 06) is evident in the findings and outcomes discussed here. Applying Gibson's ecological principles as a framework for ecological artistic research enabled a deeply integrated experiential and analytical engagement with the light-perceiver-environment nexus (Finding 04).

In this project the attentive observation of light was an education of attention – an education that demanded a new ecological approach. Learning to see ecologically meant uncovering and relinquishing existing patterns of thinking – a challenging experience which exposed the limits of my personal capacity for conceptual expansion and new understanding. Through persistence, repetition and prolonged attentive observation, the act of perceiving myself in the light-perceiver-environment nexus became synonymous with a conscious awareness of the expansive, entwined network of relationships<sup>575</sup> that govern experience in an ecological world.

A final moment which articulated the many interrelated layers of this project occurred whilst hanging the completed *The Orbit Series* prints for exhibition. When viewed behind glass, the light samples of my original observations merged with my reflection and the reflected light of the gallery space. One helical cycle of observation embedded and looped inside another, in which I saw myself seeing what I had seen, and saw myself seeing myself seeing. It was a perfect elucidation of the systemically entwined interrelation between light and perceiver (Figure 6.11, p. 164).

## 6.5 Daylight Observations - Summary

In this chapter the Gibsonian methodology, the six defining principles and the Gibsonian framework for ecological artistic research were tested and examined through the practice-based observation of light and were shown to provide an effective and rigorous experiential research ecology. The findings from this project indicate that the framework for practice-based ecological artistic research could effectively facilitate an education of attention through the rigorous observation of light.

*Daylight Observations* employed and tested the artistic research methods of Durational Observation, Ecological Lens and Reflective Artistic Practice in response to the second research question. These methods were shown to enable a rigorous research process based on the observation of light that did facilitate an ecological education of attention. Embedding the Ecological Lens method into the durational observation process provoked renewed ecological thinking and perspectives, effectively integrating Gibson's theory into the practice-based investigation. Similarly, the Reflective Artistic Practice method afforded an examination of Gibson's principles through artistic enquiry. Using visual analysis, emergent ecological patterns were revealed in the

research processes and visual data sets. These patterns of information were translated into a series of artworks which reflected and elucidated the ecological themes emerging from the project.

In examining the systemically entwined interrelation between light and perceiver, *Daylight Observations* explored the following themes: light as an ecological phenomenon, light and time, light and darkness. These themes were investigated through experiential artistic research and led to an expansion in my perceptual awareness. In turn, this enabled new ecological conceptions and experiences within the light-perceiver-environment nexus. Situating myself within the fluctuations and rhythms of this expanded ecological system unified by light meant adapting my thinking to accommodate an emerging ecological way of seeing.

*Daylight Observations* indicated that Gibson's theory did afford an effective methodology for ecological artistic research. I resolved to undertake one final observational project to confirm these findings and test the Gibsonian methodology further. The final project, *Earth Below Me Sky Above* is presented in the following chapter.

.....  
<sup>575</sup> *Archaeologies of Presence*, ed. by Gabriella Giannachi, Nick Kaye, and Michael Shanks (Abingdon: Routledge, 2012), p. 50



Chapter Seven: Project Four

# Earth Below Me Sky Above

Figure 6.11: *The Orbit Series* (2016),  
Michaela French, 'Balance-Unbalance',  
Ocean Studios, Plymouth, UK.

## 7.1 Earth Below Me Sky Above - Introduction

Following the Gibsonian methodology, the year-long *Daylight Observations* project facilitated a journey that revealed a far-reaching interconnected system unified by light. From this broad ecological foundation, I developed the parameters for my final artistic research project, *Earth Below Me Sky Above*.

This project was governed by Gibson's concepts of the ambient optic array, light as information, mutuality and reciprocity, and took place from January 1st to December 31st, 2017. As with the previous projects, *Earth Below Me Sky Above* addressed the first research question by examining how an experiential investigation of light based on Gibson's ecological principles might facilitate an education of attention through the rigorous observation of light.

The project followed the five stages of the Gibsonian research framework specified in Section 3.4 (p. 96). Building on my role of artist-researcher in *Daylight Observations*, as a perceiver on a planet orbiting in an immense universal system, the *Earth Below Me Sky Above* project continued to expand my education of attention in ecological light.

## 7.2 Description of the Artistic Research Process

### 7.2.1 Setting the Intention

*Earth Below Me Sky Above* was the final practice-based investigation in my series of four artistic research projects. As with the previous projects, this enquiry examined the systemically entwined interrelation in the light-perceiver-environment nexus. In addition, following the expansion of my ecological understanding in *Daylight Observations*, I aimed to continue developing my perceptual awareness and cultivating my ecological worldview in this final year-long enquiry.

### 7.2.2 Stage 01: Light as Information

In the initial stage of this Gibsonian research enquiry I defined the specific light information that would be observed and gathered in *Earth Below Me Sky Above*. Once again, the observation of light was situated in Gibson's ambient optic array, but the way of observing the light evolved in this investigation. In situating myself as artist-researcher in this project, I consciously framed my observations with an expanded ecological perspective: placing myself in my environment, on the earth, orbiting the sun in an expansive universal system. From this perspective, the act of observing light was synonymous with being present in light, and the observation of light became an experience of light in this investigation.

Whilst the fluctuations of hue, saturation, luminance and quality of light in the field of the ambient optic array remained the focus of attention, my awareness during the observation process extended to the full ecology of light that surrounded me, I did not observe a single point of light but experienced the field of light that illuminated the environment where each observation took place. In *Earth Below Me Sky Above* light was an immersive, ecological phenomenon which was significantly easier to experience than to articulate or record.

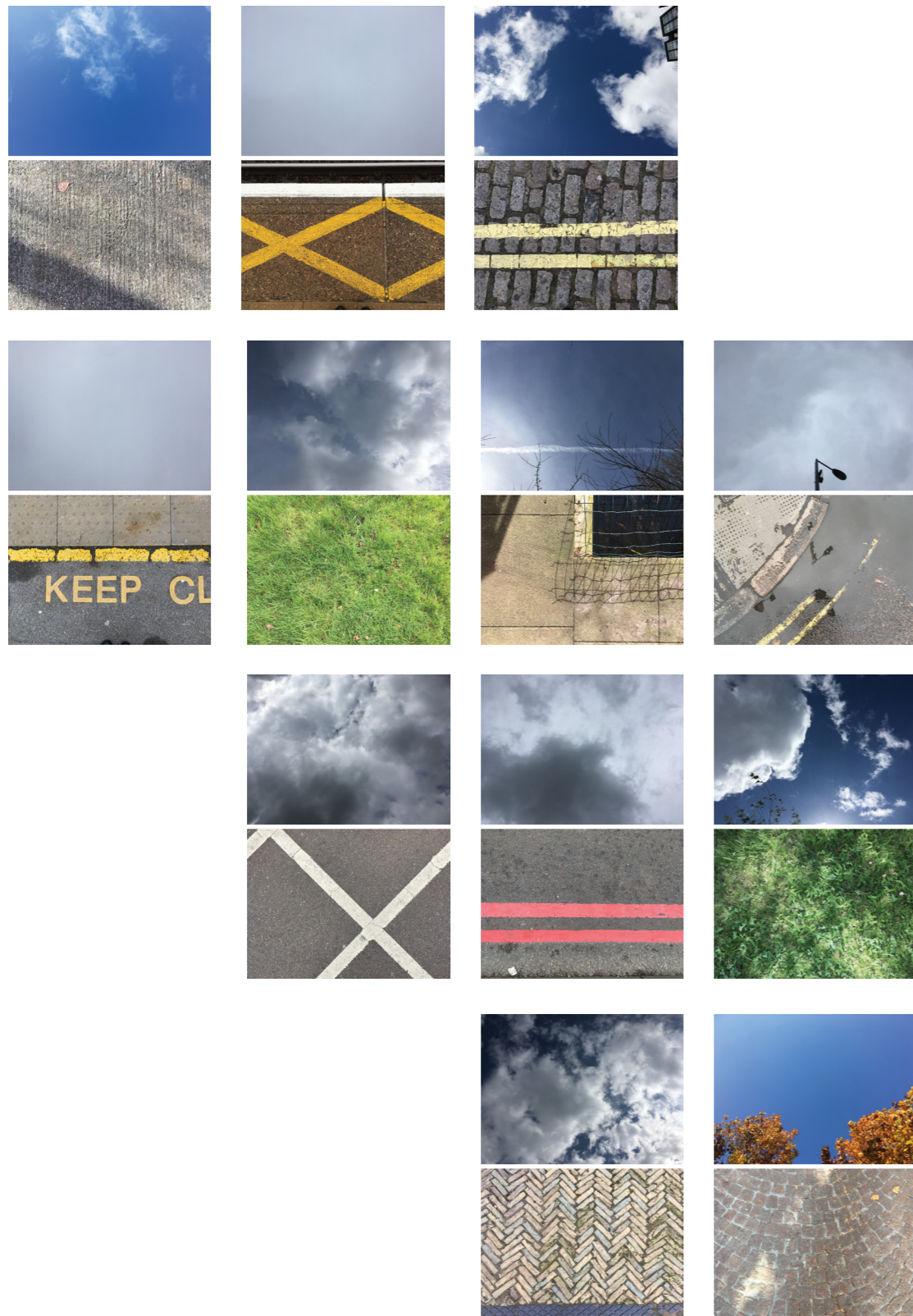

Figure 7.1: Ground and Sky, *Earth Below Me Sky Above* (2017), Michaela French Selected documentation.

### 7.2.3 Stage 02: A Perceptual Ecology

*Earth Below Me Sky Above* was situated in the reciprocal ecology of the light-perceiver-environment nexus. The emphasis was on light as experience, and the observation of light took place in ‘the total spectrum’<sup>576</sup> of perceptual experience. This systemic perceptual ecology was substantially broader than the one I had defined in first project, *A Year of Light*, three years earlier.

The intended structure of *Earth Below Me Sky Above* was to pursue a year-long observation of light, undertaken through a data collection phase, followed by Reflective Artistic Practice. Building on the recurring theme of the cumulative impact of a small repetitive action, the light observations took place over a ten-minute period beginning at 12.00 midday, every day, for 365 days.

#### Durational Observation

The Durational Observation method was applied as the primary means of data collection in accordance with the description in Section 3.5 (p. 97). As in the previous project, I adopted a dual role as artist-researcher and light sensor, using direct perception to undertake my practice-based observation of light. I intended to record light data, as I had in previous projects, both as direct experience and using additional recording techniques. No recording system could capture the breadth of information I experienced in the total perceptual spectrum, but a record was required. I decided to document this immersive experience using a combination of digital photography and HD video. Each day throughout the year I recorded two photographs and two very short videos (10 seconds), one of the ground at my feet and other of the sky over my head (Figure 7.1, p. 168). These films and photographs served as a record of my ten-minute experiential observation of light. The visual data sets produced during this project consist of 365 videos and photographs of the light in the sky and an equivalent set of recordings of light on the ground. These visual data sets were intended to provide the raw material for the Reflective Artistic Research phase of the project.

#### Ecological Lens

A final ecological lens experiment, *States of Becoming*, was applied during the *Earth Below Me Sky Above* project. Influenced by the recurring temporal themes of duration and change over time that emerged in the previous projects, *States of Becoming* invited an examination of how persistence and change are conceived in an environment. In the practice of observing the ambient optic array, light was in a continuous state of flux. From an ecological perspective, the substances and surfaces illuminated by light were also in transition from one form to another. Gibson suggested that ‘it is better to speak of persistence under change’<sup>577</sup> as the “permanent objects” of the world [...] are actually only objects that persist for a very long time.’<sup>578</sup> From this position, the States

576 Steer, 1989, p. 98.

577 Ibid.

578 Gibson, 1979, p.13.

of Becoming lens continued the conceptual dissolution of boundaries between the self and the world begun in *The Membrane is Permeable* (Section 4.3, p. 106) and *There is No Membrane* (Section 5.2, p. 125), and expanded the ecological insights from the Three Black Squares experiment.

*Earth Below Me Sky Above* provided a dedicated time each day to examine the conceptual proposition of States of Becoming in relation to my expanded ecological environment and my experiential observations of light. This Ecological Lens was once again embedded within the Durational Observation process. Viewing the world through the States of Becoming lens as a practice of ecological looking every day over a year enabled me to integrate new ways of seeing into my enquiry.

### Reflective Artistic Practice

In addition to Durational Observation and the Ecological Lens research methods discussed above, the Reflective Artistic Practice method was intended to be used in *Earth Below Me Sky Above* to examine and review the visual data sets from the durational observation process. However, unlike the previous projects, no completed artworks were produced using the visual data collected in this investigation. The reasons for this variation will be discussed in Section 7.4 (p. 174).

Attunement to Light, Emergent Patterns, and Unconventional Affordances were the evaluation criteria applied in *Earth Below Me Sky Above*. This followed the previous projects and the description in Section 3.6 (p. 97).

### 7.2.4 Stage 03: Attentive Observation (Data Collection)

Having defined the perceptual ecology that framed the project, the *Earth Below Me Sky Above* enquiry commenced with a ten-minute experiential observation of light at 12.00 midday on January 1st, 2017. The location of this first observation was in Hertfordshire, England. The majority of observations took place in the UK; however, during the periods 4th to 25th January and 25th to 31st December 2017, the observations took place on the other side of the world, in south-eastern Australia.<sup>579</sup>

The observations followed the same process each day. At 12.00 midday, I stood outside for ten minutes, looking at the sky and the ground beneath my feet. I took time to notice the light surrounding me. I observed the hue, saturation, luminance and quality of light that illuminated my environment and sought out variations within the ten-minute observation period. In this immersive process, I extended my attention to the broader ecological environment, envisaging myself immersed in the fluctuating field of the ambient optic array within an expansive universal system. This thinking was derived from the *Daylight Observations* project and the notion of light as a connection between me, 'here' and 'out there' examined in *The Old Lookout* project (Section 5.4.3, p. 137) I observed the fluctuations and changes in the light I experienced over the year of this project, but I did not extract this information as data samples, as I had in the *Daylight Observations* project. Instead, each day at the end of the ten-minute experiential

579 Travelling to Australia from the UK during the *Earth Below Me Sky Above* project contributed to the experience of an interconnected global system, whilst raising ethical questions about the contribution such travel makes to the system.

observation of light, I turned my camera to the ground to record the light reflected from the surfaces and objects at my feet and then turned my camera upward to record the light reflected from the clouds and atmosphere of the sky. I recorded one short film and one photograph of the earth and the sky to document my experiential observational process (Figure 7.1, p. 168).

The ecological lens States of Becoming was embedded within this attentive observation. This lens invited me to look at the surfaces, substances and structures in my environment as being in states of transition, changing from one form to another over varying durations. To observe the flow of light or a cloud through the States of Becoming lens correlated with my established view of the world. However, to observe a stone, a building, or the earth itself as transient required imagination and revealed a temporal horizon – a durational range in which change was directly observable and beyond which the world and the objects within it appeared fixed.

On a day-to-day basis nothing extraordinary happened in the durational observation process in *Earth Below Me Sky Above*. I immersed myself in the attentive observation of light as experience, I observed fluctuations, variation and change over time, I observed the earth turning, and I observed myself observing. This meta-observation corresponded with Gibson's notion that perceiving an environment is concomitant with co-perceiving the self.<sup>580</sup> This correlated with second-order cybernetics<sup>581</sup> by integrating my perceptual experience and influence into the observation of the larger system. As I had learned in the previous projects, a series of small, seemingly insignificant repetitions could, through cumulative effect, produce a significant impact. This meta-observation added a new layer of influence to my research process.

### 7.2.5 Stage 04: Ecological Pattern (Reflective Artistic Practice)

From the outset of *Earth Below Me Sky Above*, I was aware that the video recordings and photographs I recorded in this project were incapable of capturing the breadth of my year-long experience of observing light. As such, the recordings did not provide data in the same way as the previous observations. However, I was optimistic when embarking on the Reflective Artistic Practice stage of the project that through analysis and review the data would reveal emergent patterns, to provide insights into my observational process as the previous investigations had done.

The photographs provided a visual record of the light and surfaces I had observed, and the short videos expanded this information with sound and movement. I could ascertain the number of grey sky days compared to blue sky days, I could compare the high-key light of summer to the muted light of winter, the harsh Australian light to the soft light of England, but collectively the data sets did not speak of the experience of light in an ecological universal system. The discrepancy between the data and my immersive observational experience was vast.

For sake of the research I felt obligated to produce an artistic outcome, but nothing

580 Ibid., pp.195, 245.

581 See Section 1.3.4 (p. 52) for a description of second-order cybernetics.



Figure 7.2: *Your glacial expectations* (2012), Olafur Eliasson and Günther Vogt. Mirrors, trees, chairs, sheep. Installation view: Kvadrat, Ebeltoft, Denmark. Photo: Annabel Elston. Courtesy of Olafur Eliasson © 2012.

worked. I considered projected video and photographic installations, but reasoned it would be more effective to simply experience the world by standing in it. I considered working with mirrors in the landscape to bring the sky to the ground, but this repeated an idea, that had been previously explored by artists Olafur Eliasson (Figure 7.2, p. 172) and Anish Kapoor. There seemed little value in duplicating these visions, and the intention of any artworks I might produce was to emphasise the ecological experience of light as framed by an expansive Gibsonian ecological worldview.

My data did not reflect this ecological perspective, and as a result my attempts to produce artworks derived from the documentation felt like a gesture rather than a valuable contribution to my research. So, I stopped. This was a challenging and disconcerting point to reach near the end of my research process. For some time, I considered the *Earth Below Me Sky Above* project a failure. However, I continued to question why I hadn't managed to bring the artistic practice to a satisfactory conclusion. I returned to the documentation a number of times, in case I had missed something and to see if I could find a new way forward. In one these cycles approximately a year after I first paused the project, I had the realisation that the project was already complete.

In this moment, it became clear that my artistic practice had taken place in the attentive observation of light during the *Earth Below Me Sky Above* project. The artistic practice was synonymous with the durational observation field study. The time spent contemplating and sensing light over the year using the Gibsonian methodology was itself a form of reflective ecological artistic practice. From this position, there was no need for to produce artworks from the photographic and video documentation in a retrospective studio-based enquiry.

*The Earth Below Me Sky Above* project had not followed my original plan, but it had not failed; rather, it precipitated a major shift in my artistic practice, away from an object-oriented approach to an experiential exploration of light which took place in a real-time interaction with the light-perceiver-environment nexus. Like the fluctuations in the light I observed over the year, my artistic practice had become experiential, immersive, transitory and site-specific: an exploratory artistic enquiry taking place through direct interaction with the light of an orbiting planet. This realisation was exciting, and opened new possibilities for future directions in my ecological artistic research.

### 7.3 Earth Below Me Sky Above - Findings

#### Attunement to Light

01. The attentive observation of light became synonymous with the immersive experience of light. Looking at light was no longer a valid proposition. The act of looking was an experience of being in an expansive ecological field of light. This way of seeing does not appear to be reversible.
02. Attunement to light as an immersive ecological experience altered the existing artist/subject relationship. Situated within, and encompassed by, light, the artistic practice became experiential, temporal and site-specific, corresponding with real-time fluctuations in the light-perceiver-environment nexus.

### Emergent Patterns

03. Everything is in a state of becoming: moving from one form towards another. Duration determines ease of observability. There is no permanence, there is no finitude, there is just a continuum. This thinking has become my normal way of seeing the world.
04. My artistic practice is in a state of becoming. I am in a state of becoming. This is an outcome of an education of attention undertaken through the attentive observation of light.

### Unconventional Affordances

05. The shift from an object-oriented to an experiential artistic practice precipitated by the attentive observation of light opens up the possibility of a new form of experiential ecological artistic enquiry.
06. The proposition of an ecological artistic observatory emerged as a potential future direction for my ecological artistic research: a critical creative platform intended to cultivate an ecological worldview.

## 7.4 Discussion: A New Level of Description

### 7.4.1 Light as Immersive Experience

*Earth Below Me Sky Above* began with an understanding of light as an ecological phenomenon. This learning had been cultivated in the previous projects, particularly in *Daylight Observations*, and was informed by the Three Black Squares experiment, which showed that the narrative that defines light also determines how we conceive the world. From this foundation, and in correspondence with Gibson's concept of the ambient optic array, observing light in *Earth Below Me Sky Above* was synonymous with the immersive ecological experience of being in the world (Finding 01). Thus, the attentive observation of light can be understood as an active, direct and holistic engagement with the light-perceiver-environment nexus. This process integrated all the available information in a unified perceptual experience. In defining light as ecological, I had also defined the artistic practice of observing light as holistic. As discussed in *A Year of Light* (Section 4.5, p. 114), ecological light is accompanied by holistic space:

#### holistic space - ecological light

This concept has been present throughout all four artistic research projects and was examined using the Ecological Lens experiments in each of these enquiries. However, in *Earth Below Me Sky Above* the complementarity of holistic space and ecological light was translated into action and embedded in the practice-based research enquiry. This shift demonstrated a refinement in my understanding of Gibson's theory, as this once purely intellectual idea filtered into and integrated with my experiential knowledge by educating my attention through repeated practice.

The idea of ecological light correlated with my real-world experience and with Gibson's proposition that 'the persistence of the environment together with the coexistence of its parts and the concurrence of its events are all perceived together'.<sup>582</sup> In *Earth Below Me Sky Above* the attentive observation of light evolved to align with this understanding, expanding beyond visual perception into an immersive and expansive holistic perceptual ecology.

This situated me, as artist-researcher, in an immersive experiential act of looking which integrated multiple perceptual systems in the pickup of information. As previously established (Sections 2.4.5, p. 67 and 5.4, p. 135), examining my experience across 'two or more sensory modes simultaneously'<sup>583</sup> enabled a 'process of information comparison'<sup>584</sup> which revealed expanded patterns of observation. For example, I considered the visual quality of light in relation to environmental temperature and the touch of light on my skin to compile an understanding of the visual impact of heat and cold; similarly, the changing length and depth of shadows, the colour of light and accompanying sounds were indicative of seasonal changes. Whilst this information was not recorded as formal data, attending to these details over the year refined my capacity to see, feel and experience these interactions more precisely. Through the repetition of this attentive practice I examined the systemically entwined interrelation between light and observer through direct experience, elucidating this reciprocal relationship by being part of it, by contributing to it in a conscious way. I attributed these changes to an expansion in my perceptual awareness brought about by an education of attention.<sup>585</sup>

### 7.4.2 An Emerging Ecological Artistic Practice

In *Earth Below Me Sky Above* my interest lay in 'the total spectrum'<sup>586</sup> of perceptual experience. In the earlier projects, I differentiated between specific variables to gather particular information in the data collection process. Hue, saturation and luminance information, for example, was collected to produce the data sets in *Daylight Observations*. This data provided insightful ecological perspectives and generated beautiful artworks, but in observing light as a holistic ecological experience, extracting data was counterintuitive. Following Gibson's principles of mutuality and reciprocity, light data was more effectively examined within the breadth, depth and real-time fluctuations of the light-perceiver-environment nexus.

Whilst I recorded short films and photographs during my observation process each day, they did not adequately capture the immersive experience of my attentive observations, and served only as partial documentation of my holistic experience of observing light in the ambient optic array. The use of video did contribute the additional information of sound and movement to the documentation; however, like the photographs, the rectilinear frame restricted a broad ecological view.

.....  
582 Gibson, 1979, p. 222.

583 Anderson, 1996, p. 82.

584 Ibid.

585 Gibson, 1979, p. 254.

586 Steer, 1989, p. 98.



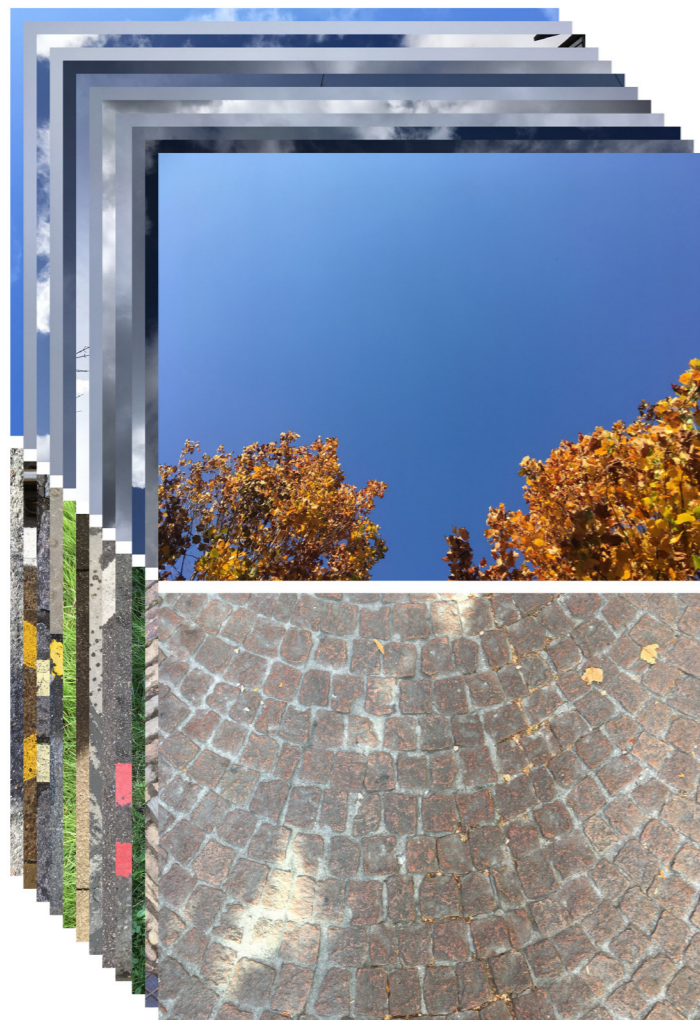

Figure 7.3: Here and Out There, *Earth Below Me Sky Above* (2017), Michaela French Selected documentation.

In the previous projects, and in the initial planning of this project, there was a clear distinction between the data collection process and the Reflective Artistic Practice. I considered attentive observation as a data-gathering process, rather than as artistic practice. However, as previously discussed, during *Earth Below Me Sky Above* the possibility emerged that the attentive observation of light could itself be a form of ecological artistic practice (Finding 02).

Without comprehensive visual data sets, my analysis contributed little insight to the research, and the retrospective Reflective Artistic Practice method offered limited artistic value in this project. With reflection and hindsight this artistic analysis was unnecessary, as my ecological artistic practice had already taken place during the Durational Observation data-gathering process (Finding 02). In *Earth Below Me Sky Above* the reflective artistic practice was entwined with the attentive observation process. A new artistic practice emerged (Finding 05) that reflected the experiential, temporal and site-specific qualities of my observations and interactions with light. This new ecological reflective artistic practice moved away from an object-oriented focus to a highly exploratory, entirely subjective experiential approach which could respond to the fluctuations in the light-perceiver-environment nexus in real time.

This emergent ecological artistic practice correlated with the Gibsonian principles governing the enquiry: it focused on light as information; it took place in a reciprocal perceptual ecology; it was undertaken through attentive observation, and was responsive to emergent patterns of perception and behaviour over time. The emergence of this experiential ecological artistic practice (Finding 05) can be considered an unconventional affordance, derived from the cumulative impact of a prolonged attentive observation of light.

The shift away from an object-oriented practice raised the question of how the experiential observation of light might be artistic practice. There is not the scope for an in-depth examination here; however, the ecological artistic practice of observing light can be seen to align with the artistic practice of walking as an education of attention<sup>587</sup> and with the ecological artistic practices discussed in Reeve's performative Gibsonian research (Section 2.4.6, p. 70). There is scope for future investigation in this area.

Whilst *Earth Below Me Sky Above* produced no object-based artistic outcomes, the Gibsonian research framework was once again shown to effectively facilitate an ecological education of attention through the experiential artistic observation of light. Over the course of this year-long enquiry the process of attuning to light altered and expanded my perceptual awareness and led to a redefinition of the structure, mode and process of my artistic practice. This change demonstrated that my actions, behaviours and artistic practice were also susceptible to maturation and learning<sup>588</sup> through the repetitive and immersive practice of observing light (Finding 04).

.....  
587 Tim Ingold, 'The Maze and the Labyrinth: Walking and the Education of Attention', in *Walk-On*, ed. by Mike Collier and Cynthia Morrison-Bell, exh. cat. (Sunderland: Art Editions North, University of Sunderland, 2013), pp.14-19.

588 Gibson, 1979, p. 245.

### 7.4.3 Patterns of Persistence and Change

The shift to experiential ecological artistic practice that occurred during *Earth Below Me Sky Above* corresponded with the notion of impermanence and change inherent in the ecological lens experiment States of Becoming (Finding 04). This experiment was based on the premise that all surfaces, substances, structures and objects are in a constant state of flux (Finding 03). For Gibson, 'permanence is relative'<sup>589</sup> and duration determines how persistence, transience and change are conceived.<sup>590</sup> Whether over a day, a year or a millennium, change is constant. Permanence is an illusion which reflects the limits of perceptual and conceptual capacity; objects that persist beyond a perceivable temporal horizon appear as static, fixed, and immutable.<sup>591</sup> In the same way that There is No Membrane blurred the spatial boundaries between self, 'here' and 'out there'<sup>592</sup> (Figure 7.3, p. 176 and Section 5.4.3, p. 137), States of Becoming was applied throughout *Earth Below Me Sky Above* to encourage a new way of seeing and conceiving (Finding 03); moving beyond perceived temporal boundaries to observe change over extended periods of time. Gibson suggests that the distinctions of 'present-past-future'<sup>593</sup> are relevant only in the perception of the self; the environment, he argues, is timeless<sup>594</sup> insofar as it is not divided into discrete moments.<sup>595</sup> This idea is reflected in Norman Bryson's notion of the flower as 'inhabited by its past as seed and its future as dust'.<sup>596</sup>

The States of Becoming lens was used to observe the world in terms of the 'fluxes and flows of the materials',<sup>597</sup> substances and surfaces I encountered. Initially, this occurred within my attentive observation process, but over the year this way of seeing gradually integrated into my daily life. The water flowing from my tap was once rain, the tree outside my window was once a seed, my town was once a forest. Patterns of transience, impermanence and change were evident in every thing (Finding 03). One form morphed in continuous motion into another over multiple durations and scales. States of Becoming afforded a way of seeing temporal ecological objects in states of

589 Gibson, 1979, p. 245.

590 Gibson describes temporal perception as follows: 'The changes that are perceived, those on which acts of behavior depend, are neither extremely slow nor extremely rapid. Human observers cannot perceive the erosion of a mountain, but they can detect the fall of a rock. They can notice the displacement of a chair in a room but not the shift of an electron in an atom. The same thing holds for frequencies as for durations. The very slow cycles of the world are imperceptible, and so are the very rapid cycles. But at the level of a mechanical clock, each motion of the pendulum can be seen and each click of the escapement can be heard. The rate of change, the transition, is within the limits of perceptibility'. (Gibson, 1979, pp. 11-12.)

591 Gibson, 1979, p.13.

592 Ibid., p. 207

593 Ibid., p. 195

594 Ibid.

595 Steer, 1989, p. 94.

596 Norman Bryson, 'The Gaze in the Expanded Field', in *Vision and Visuality*, ed. by Hal Foster (Seattle, WA: Bay Press, 1988), pp. 98-99.

597 Ingold, 2013, p. 6.

flux and invited 'a softening or even dissolution of boundaries between self and world'.<sup>598</sup>

Over the year of observing these cycles of impermanence and change in the light-perceiver-environment nexus, in the earth's orbit and in the objects and substances of life, these patterns of transience expanded to include my own experience, my role as artist-researcher and my artistic practice (Finding 04). It was fitting that my final project, *Earth Below Me Sky Above*, should conclude with a new level of description for the future direction of my practice-based artistic research (Finding 06); an ecological artistic observatory intended as a critical creative platform for the cultivation of an ecological worldview.

### 7.5 Earth Below Me Sky Above - Summary

*Earth Below Me Sky Above* demonstrated that Gibson's ecological approach to visual perception, when applied as a research framework effectively facilitates a rigorous experiential ecological artistic enquiry.

1. Which principles and concepts from Gibson's ecological approach to visual perception might be adapted and applied to frame ecological artistic research that facilitates an education of attention through the rigorous observation of light?

In responding to my first research question, *Earth Below Me Sky Above* showed that when applied as a research framework the Gibsonian principles of light as information, direct perception, perceptual maturation, ecological pattern, affordances and a new level of description effectively facilitated an education of attention through the observation of light. This was evidenced by an increased attunement to light as an ecological experience, an awareness of ecological patterns of change and the development of an ecological approach to artistic practice.

2. What practice-based methods emerging from a Gibsonian research framework might be applied through artistic practice to cultivate an ecological worldview?

The research methods applied in the project – Durational Observation, Ecological Lens and Reflective Artistic Practice – successfully facilitated ecological artistic research based on the observation of light. Using these methods, Gibson's ecological theory was applied through artistic enquiry to precipitate an ecological worldview in which experiential and intellectual knowing coalesced. The education of attention facilitated by the Gibsonian framework expanded my perceptual awareness, generating new knowledge and enabling me to cultivate a deeply integrated ecological conception of the light-perceiver-environment nexus.

*Earth Below Me Sky Above* did not unfold as initially planned, but this apparent failure ultimately provided valuable insights and learning that resulted in the development

598 Davies, 2005, p. 95.

of an ecological artistic practice and presented a previously unimagined direction for my future research. In the next chapter, I summarise the findings from my four artistic research projects to analyse and evaluate the limitations and value of my Gibsonian methodology as a framework for practice-based ecological artistic research.

## Chapter Eight

---

# Taking the Long View

## 8.1 Introduction

In this concluding chapter, I summarise the findings from my four artistic research projects to articulate the final outcomes from my practice-based enquiry. As discussed in Section 3.6 (p. 99), I examine the combined outcomes of these four projects as a cumulative case study to evaluate the efficacy of the Gibsonian framework as a conceptual and structural foundation for practice-based ecological artistic research. I articulate my original contribution to knowledge within the emerging field of ecological artistic scholarship, and I highlight the limitations of my study and discuss the future directions of my research. My two research questions have defined the line of enquiry I have navigated in this study:

1. Which principles and concepts from Gibson's ecological approach to visual perception might be adapted and applied to frame ecological artistic research that facilitates an education of attention through the rigorous observation of light?
2. What practice-based methods emerging from a Gibsonian research framework might be applied through artistic practice to cultivate an ecological worldview?

In responding to these questions, I developed the Gibsonian methodology and framework for practice-based ecological artistic research. I have applied and tested this framework through the four artistic research projects using the observation of light to facilitate an education of attention. In the following section, I summarise the findings from these four projects and evaluate them against the criteria defined in Section 3.6 (p. 99) to establish the final outcomes of my practice-based observations of light.

## 8.2 Findings

### 8.2.1 Findings Overview

This research enquiry was premised on Gibson's proposition that the perceptual system can be refined and improved with practice<sup>599</sup> to expand capacity and awareness. The repetitive process of attentive observation enables a perceiver to grow into knowledge<sup>600</sup> through an education of attention. In the ecological reciprocity of the light-perceiver-environment nexus, knowledge of the world expands as the perceptual system becomes increasingly sensitised; as experiential knowing expands, a perceiver is able to cultivate new conceptions of their environment.

In this Gibsonian study, new knowledge was generated by refining and educating my perceptual awareness through the attentive observation of light. The findings from my four artistic research projects, *A Year of Light*, *The Old Lookout*, *Daylight Observations* and *Earth Below Me Sky Above*, provide evidence of attunement to light, perceptual

.....

599 Gibson, 1979, p. 254.

600 Ingold, 2013, p.13.

learning and new conceptions of the world. I summarise the findings from these four projects using the established evaluation criteria: Attunement to Light, Emergent Patterns and Unconventional Affordances. I draw out common themes, patterns and new learnings from the outcomes of these four projects to identify and articulate the overall outcomes of my practice-based artistic research. Through this analysis the Gibsonian framework for the practice-based ecological artistic research is shown to facilitate an education of attention capable of generating new knowledge in the three established areas of:

Evaluation Criteria and Research Outcomes	
Evaluation Criteria	Research Outcomes
Attunement to Light	<ul style="list-style-type: none"> <li>i. Expanding Horizons</li> <li>ii. A Refined Way of Seeing</li> </ul>
Emergent Patterns	<ul style="list-style-type: none"> <li>iii. Change Over Time</li> <li>iv. Symmetries of Scale</li> </ul>
Unconventional Affordances	<ul style="list-style-type: none"> <li>v. An Ecological Worldview</li> <li>vi. Ecological Artistic Practice</li> </ul>

Table 8.1: Evaluation Criteria and Research Outcomes (2019), Michaela French.

In the following sections, I discuss how the findings in each of these categories provide evidence that the Gibsonian research framework successfully facilitates an education of attention through the rigorous observation of light.

### 8.2.2 Attunement to Light

In each of the four artistic research projects, my attunement to light increased as my practice of attentive observation combined with a growing ecological conception of the world. A re-ordering of visual hierarchy prioritised the quality, structure and variations of light over objects, surfaces and substances, and marked a significant change in my way of seeing. This was followed by an awareness of non-visual light as perceptual information, which merged with an experiential understanding of light as the fluctuating unified field of Gibson’s ambient optic array. Over time my observation of light became synonymous with being immersed in light. These perceptual refinements altered how I situated myself in each of the four projects and fundamentally transformed my conception of the world.

The visual data sets and completed artworks from my artistic research provide a testament of this progressive refinement in my way of seeing. The Durational Observation and Ecological Lens methods were critical in generating these research outcomes. This thesis thereby finds that the Gibsonian framework for ecological artistic research improves the perceiver’s attunement to light through an education of attention.

As attunement to light increases:

#### i. Expanding Horizons

the perceiver’s field of view expands progressively to integrate personal and universal scales, reflecting a reciprocity between ecological thinking and the perceiver’s conception of the world.

#### ii. A Refined Way of Seeing

the perceiver’s awareness is refined, and an artistic sensibility emerges in the way light is experienced and observed in the world.

### 8.2.3 Emergent Patterns

My improved ability to recognise emergent ecological patterns as a result of my observations of light offers evidence of refinement and attunement in my perceptual system. Through attentive practice my observation process became more ‘subtle, elaborate, and precise’,<sup>601</sup> revealing increasingly detailed ecological patterns over time.

One consistent pattern in my study was the repetition of a single action contributing to a larger whole. This pattern was evident in my observations of light, in the cumulative expansion of perceptual awareness, in the emergence of my ecological worldview, and in the visual data sets and artworks produced in each artistic research project.

Other emerging patterns included the complementarity of light and dark as an infinitesimal array of observable fluctuations;<sup>602</sup> the orbiting earth moving around a comparatively static sun; the interrelation of light and duration and multiple concurrent timescales in my observation process, and the flux and impermanence in the objects and surfaces uncovered by the States of Becoming ecological lens.

The Durational Observation and Reflective Artistic Practice methods were effective in drawing out these patterns and revealed my growing attunement to the variant and invariant patterns of information<sup>603</sup> Steer and Anderson identified as fundamental to the artistic process (Section 2.4, p. 52). The emergence of these patterns indicated improved perceptual awareness and evidenced the integration of Gibson’s ecological principles into my thinking and artistic practice. Based on these observations, this thesis finds that the Gibsonian ecological framework for the practice-based artistic observation of light does effectively facilitate an education of attention. The emergent patterns evident in my Gibsonian investigation of light show:

#### iii. Change Over Time

the attentive observation of light as an ecological artistic practice is a study of change over time which takes place across multiple concurrent temporal and spatial scales.

601 Gibson, 1979, p. 245.

602 Cubitt, 2014, p. 267.

603 Steer, 1989, p. 95.

#### iv. Symmetries of Scale

an education of attention is derived from the repetition of a single iterative action that contributes to a cumulative body of knowledge. Symmetry of scale frames an education of attention as a single iteration in a larger ecological cycle of perceptual development.

### 8.2.4 Unconventional Affordances

In this study an unconventional affordance is new knowledge which signifies change in the perceptual system (Section 3.3, p. 93) The unconventional affordances that emerged from the four artistic research projects show a progressive shift toward an ecological worldview and provide evidence of perceptual maturation and learning associated with an education of attention.

The unconventional affordances emerging from the artistic projects included the evolution of the artist-researcher role from objective observer to ecologically entwined perceiver and light sensor, the Subjective Colour Swatch technique for recording light data, and the concept of the light-perceiver-environment nexus. The softening, broadening and dissolving of conceived boundaries between light, myself and the world initiated by the repetitive focus of the Durational Observation and Ecological Lens methods was also considered an unconventional affordance, as was the transition of my artistic practice from object-oriented to an experiential artistic enquiry based on the real time observation of light. These outcomes correlated with an increasingly ecological understanding of the systemically entwined interrelation between light and perceiver which demanded a renewed description of the world. These findings show that the Gibsonian framework for ecological artistic research was effective in creating the research environment required to produce new knowledge through an education of attention based in the rigorous observation of light. This study has shown the Gibsonian framework for ecological artistic research affords:

#### v. An Ecological Worldview

an ecological worldview which can be cultivated when Gibson's core principles are used to facilitate an education of attention through the observation of light. Cultivating an ecological worldview through the practice-based observation of light demands focused attention, flexibility, openness, commitment, resilience and stamina.

#### vi. An Ecological Artistic Practice

the emergence of an ecological artistic practice, which corresponds with Gibson's theory to examine and elucidate the systemically entwined interrelation between light and perceiver through direct artistic interaction with the light-perceiver-environment nexus.

In the following section I examine the combined outcomes of these four projects as a cumulative case study to evaluate the overall efficacy of the Gibsonian framework as a conceptual and structural foundation for practice-based ecological artistic research.

## 8.3 Research Findings and Conclusions

To reiterate, analysis of the cumulative findings from the four artistic research projects showed that an education of attention facilitated by the Gibsonian ecological framework resulted in the research outcomes outlined in Table 8.1 (Section 8.2.1, p. 184)

### 8.3.1 A Final Conclusion

Based on these outcomes, and on the theoretical and practice-based evidence presented in this thesis, I draw the following conclusions:

- i. The rigorous observation of light leads to attunement
- ii. Attunement to light leads to an education of attention
- iii. An education of attention undertaken through the rigorous observation of light using the Gibsonian research framework cultivates an ecological worldview

### 8.3.2 Discussion and Evaluation

Therefore, this study finds the Gibsonian methodology and framework for ecological artistic research, developed and applied in this enquiry, successfully facilitates an education of attention through the attentive observation of light. Gibson's ecological paradigm offered a robust conceptual and structural foundation for this research investigation, which integrated subjective observation with academic rigour. The Gibsonian methodology proposed in this study was effective in generating new knowledge through exploratory artistic enquiry based on direct perceptual interaction in the light-perceiver-environment nexus.

Gibson's ecological theory afforded my research a language for describing experience, a critical conceptual framework and a cohesive model of ecological visual perception. Gibson's thinking served as a filter that enabled me to translate my expansive, open-ended and impossibly broad experiential artistic investigation of light, into a structured, focused and purposeful exposition. This thesis and the artistic practice undertaken therein owes a debt of gratitude to Gibson and his ecological paradigm.

As a concluding response to my first research question, I return to Gibson's concepts of the ambient optic array and ecological reciprocity, and the six methodological principles I identified in Section 3.3 (p. 93):

01. Light as Information
02. A Perceptual Ecology
03. Attentive Observation
04. Ecological Pattern
05. A New Level of Description
06. Unconventional Affordances

These six Gibsonian principles were adapted and applied to create a highly effective framework for ecological artistic research. In undertaking this research, each principle

made a cumulative and iterative contribution to my education of attention.

The three research methods I developed and tested in this study were integral to, and governed by the Gibsonian ecological framework. Durational Observation provided a structure for the attentive observation of light, the Ecological Lens explored and expanded the boundaries of ecological thinking, and Reflective Artistic Practice revealed emergent patterns and produced artworks in support of these findings.

Gibson's theory was adapted and applied in this study to undertake research through the rigorous observation of light. However, the Gibsonian research framework I present is transferable and adaptable to other areas of ecological artistic research, including contemporary sound art,<sup>604</sup> responsive textiles<sup>605</sup> and performance studies<sup>606</sup> as evidenced in my contextual review (Chapter Three, pp. 89-102).

Gibson's ecological paradigm was originally derived from his real-world observations, which may account for the successful adaptation of his theory as a model for ecological artistic research. In my enquiry Gibson's focus on the experience of light and direct visual perception allowed his ecological theory to be translated with relative ease from the page to the light-perceiver-environment nexus and back again.

## 8.4 Original Contribution to Knowledge

The Gibsonian framework for the practice-based ecological artistic research developed in this study constitutes my original contribution to knowledge. My research proffers a new level of description and demonstrates the value of Gibson's theory as a framework for practice-based artistic enquiry. This research framework, the governing methodological principles and associated artistic research methods I define in this thesis contribute a new model for artistic research to the emerging community of inquiry I identify as ecological artistic scholarship (Section 1.3, p. 30). The syncretic approach of the Information Experience Design (IED) programme has been critical to my enquiry and my research contributes to IED's development as a potential field of investigation by expanding the academic discourse and practices within this programme of study.

Gibson's ecological approach has a long association with artistic practice as discussed in Chapter Three (pp. 89-102); however, my research is the first to establish and articulate a Gibsonian framework for practice-based ecological artistic research. The Gibsonian methodology and research framework I propose in this study responds to this gap in knowledge (Section 2.6, p. 84) and has been thoroughly tested in the crucible of real-world practice-based artistic enquiry undertaken in the light-perceiver-environment nexus. This ecological approach effectively facilitates an education of attention through the observation of light and has been shown to contribute to the cultivation of an ecological worldview. This contribution to knowledge is supported by a body of evidence consisting of visual data sets and light-based artworks produced through practice-based artistic research.

604 Sjölin, 2011.

605 Karanika, 2013.

606 Reeve, 2008.

My study contributes to artistic research more broadly by responding to a growing call for research approaches based in an ecological worldview. The Gibsonian framework for ecological artistic research is adaptable to any enquiry which seeks to generate reliable data, artworks and new knowledge through direct perception, ecological observation and an education of attention. In articulating the Gibsonian ecological methodology and research framework in this study, I offer a rigorous, repeatable ecological approach which is adaptable and transferable for other artist-researchers who wish to:

- > pursue a critical ecological framework for artistic research
- > elucidate ecological perceptual experience through practice-based enquiry
- > integrate subjective observation and rigorous academic investigation

The Gibsonian framework was applied in this research to examine and elucidate the systemically entwined interrelation between light and perceiver. Light plays a vital and diverse role in contemporary culture, and the Gibsonian understanding of light as ecological that emerges in this study affords an alternate perspective to the prevailing technological conception of light.

### holistic space - ecological light / digital space - technological light

When viewed as ecological, light serves as a reminder of the systemic interrelations inherent in perceptual experience. In establishing the attentive observation of light as a practice capable of cultivating an ecological worldview, my research may afford a broader contribution to the ecological imperatives that increasingly inform contemporary artistic and cultural discourse. As I established (Section 3.3 p. 93), new knowledge emerges from changing how we perceive, rather than by changing what we know. This idea is critical in responding to 'matters of concern in our world'.<sup>607</sup> Climate change, light pollution, plastic oceans, diminishing ecological interrelation<sup>608</sup> are symptoms of a broader dysfunction. As the need for fundamental behavioural change becomes more pressing, the ability to cultivate an ecological worldview through direct perception, attentive observation and exploratory action in the world becomes increasingly important. This study provides evidence of the repetitive power of a single iterative action to contribute to a larger cumulative body of knowledge. The world must grow into ecological knowledge; this symmetry of scale may be valuable in cultivating a larger collective ecological worldview. How we choose to educate our collective attention will determine the worldview we develop.

607 Patrizio, 2019, p. 180.

608 Newman, Rob, 'Steller's Sea Cow', *The Extinction Tapes*, Episode 4, BBC Radio 4, broadcast 7 November 2019 <<https://www.bbc.co.uk/sounds/play/m0009yxc>> [accessed 19 November 2019].

## 8.5 Research Limitations and Future Directions

### 8.5.1 Limitations of the Research

In this section I discuss the limitations of my investigation and indicate the future directions of my ecological artistic research.

An ecological research enquiry is inherently broad, offering many potential paths of investigation. Pursuing and maintaining a focused and specific path of enquiry has been a significant challenge throughout this study. The primary trajectory of the study has been the development of the Gibsonian research framework. The process of translating, adapting and applying Gibson's theory through artistic practice necessitated a highly subjective research approach based on my own artistic practice. In my role as artist-researcher I was the sole participant in the study; all research outcomes, findings and conclusions are based upon my subjective perceptual experience and interpretation. In traditional disciplinary research this would be considered a limitation; however, from a Gibsonian ecological perspective the subjectivity of direct perception affords 'the simplest and best kind of knowing',<sup>609</sup> the value of which lies 'in syncretism, not in depth-mining'.<sup>610</sup> This subjective positioning enabled a deeply integrated experiential and analytical engagement with Gibson's principles. The Gibsonian framework I present here is not merely theoretical conjecture; it has been tested, examined, refined and proven through rigorous experiential practice – albeit from a single point of view.

### 8.5.2 An Emerging Community of Inquiry

Throughout this thesis I have referred to the emerging interdisciplinary 'community of inquiry'<sup>611</sup> I identify as ecological artistic scholarship. Upon completion of my PhD study, I intend to contribute to this community by organising a symposium for theorists, researchers and practitioners engaged in critical ecological investigation in the arts. My initial focus would be to connect researchers from separate disciplines who share an interest in James J. Gibson's ecological approach. The longer view would extend participation to develop more networks and opportunities for interconnection within the ecological artistic scholarship community.

### 8.5.3 Pedagogical Applications

Another direction for my research is to translate the Gibsonian framework into a pedagogical model for critical ecological thinking and practice, with the aim of expanding ecological artistic scholarship in the field of art and design education. I had the opportunity to apply the ecological principles and methods developed in this research in an art/science collaboration, *If a Tree Falls in the Forest* (2018)<sup>612</sup> which brought artists and cosmologists together in an interdisciplinary public engagement

609 Gibson, 1979, p. 263.

610 Nelson, 2013, p. 34.

611 Buchanan, 2001, p. 23.

612 For further information about the *If a Tree Falls in the Forest* project see <<http://ifatreefalls.rca.ac.uk>>.

project. In February 2019, the Gibsonian research framework and methodology were applied in a participatory *An Education of Attention* workshop with MRes students in the School of Communication at the Royal College of Art. These two projects are not included in this thesis, but afforded valuable insights into the future application of my research.

### 8.5.4 Dissemination and Publication

Upon completion of my PhD, I will disseminate my research through academic conferences, research papers and peer-reviewed journals such the *Journal of Artistic Research*, *Leonardo* and *Airea* (Arts and Interdisciplinary Research). I also envisage making my research accessible to a wider audience through symposia and public presentations in non-academic artistic contexts and through the publication of my ecological research, practice and findings as a book aimed at an interdisciplinary arts audience.

### 8.5.5 Ecological Artistic Practice

Due to time limitations, a significant outcome of the research that has not been investigated further is the ecological artistic practice that emerged in the *Earth below Me Sky Above* project. As discussed, this project precipitated a shift from an object-oriented practice to an experiential ecological artistic enquiry. I am yet to explore the potential of this emergent ecological practice, but I briefly outline two projects which build on the conceptual and experiential learning this investigation afforded. The concept of the *Ecological Artistic Observatory*<sup>613</sup> is a critical platform for the creative cultivation of an ecological worldview. It occupies a space between a planetarium, a sky observatory and an exploratory artistic experiment.<sup>614</sup> *The Ecological Observatory* integrates practice-based and theoretical enquiry to examine the increasingly important role of artists in contributing to ecological imperatives and aims to facilitate a cultural education of attention through artistic practices that make a genuine ecological contribution.

A second project, *Taking the Long View*, draws on the visual data sets, artworks and ecological knowledge generated in this study to produce a 360° fulldome film.<sup>615</sup> Exploring traditional planetarium themes of light, space, the universe, and humanity's relation to it, this film breaks with scientific convention, adopting a Gibsonian approach to explore these concepts through the systemic complexity of an ecological worldview.

613 At the time of writing this thesis *The Ecological Artistic Observatory* is a conceptual framework rather than a physical location, however, future development of the project may include site-specific and/or permanent installations.

614 The Ecological Artistic Observatory may also integrate with the Fulldome Research Group; a practice-based investigation of the fulldome medium which I have led at the Royal College of Art for five years. See <<http://fulldome.rca.ac.uk/>> for further information.

615 Fulldome 360° is an immersive moving image medium, originally developed for dome-based projection in planetarium environments, but increasingly emerging as an artistic medium in its own right. For further information see: Michaela French, 'An Emerging Spherical Infinity', in: *The New Infinity: Visual Art and Music in Planetariums*, ed. by Thomas Oberender, Berliner Festspiele (Köln: Buchhandlung Walther König, 2019)



## 8.6 Closing Summary

When this study began, my initial interest was in the relationship between visual perception, light and wonder; an ecological investigation was not my intent. It was the study of light through direct perception and interaction with the world that led me to James J. Gibson's ecological approach.

The attentive observation of light has been central to this research. I have watched the earth move through its annual cycle all my life; looking at light through a Gibsonian lens in this study reframed my view. To be attentive, to watch closely and to follow with intent<sup>616</sup> allowed me to observe nuanced fluctuations and details in the light-perceiver-environment nexus, which revealed infinite levels of expansion and beauty in every perceptual ecology. Applying Gibson's ecological vision as a framework for the artistic observation of light has inspired and nurtured a systemic ecological state of mind, which on occasion opened outward into experiences of wonder, the sublime, deep interconnection, and profound insight.

Through artistic and theoretical investigation, I have demonstrated the value of Gibson's theory as the epistemological and methodological foundation for this research. I selected, elucidated and adapted key concepts and principles from Gibson's ecological paradigm to establish the Gibsonian framework for ecological artistic research. I developed and applied a cohesive set of research methods: Durational Observation, Ecological Lens and Reflective Artistic Practice, which have been shown to effectively facilitate an ecological education of attention through the rigorous observation of light.

My four artistic research projects: *A Year of Light*, *The Old Lookout*, *Daylight Observations* and *Earth Below Me Sky Above* afforded a practice-based examination of the systemically entwined interrelation between light and perceiver. The Gibsonian research framework offered an apposite structure for these projects and was applied to contain and focus the unpredictable and sometimes overwhelming real-world interactions with light that formed the basis of my experiential artistic enquiry. These projects served as a site for testing and evaluating the suitability of Gibson's principles as a research framework. The findings from these projects showed that this Gibsonian approach afforded a rich experiential territory for practice-based enquiry which, through an education of attention, can be used to cultivate an ecological worldview.

This research process taught me to trust my perceptual system, validated my subjective experience as a means of generating reliable data and afforded an education of attention in which I relinquished old modes of thinking as my ecological conception of the world expanded. The capacity of small focused iterative repetitions to create change over time was potent, and an ecological worldview emerged as my new state of being.

Five years ago, when this study began, ecological concerns were at the periphery of cultural discourse; a shift in emphasis now imbues ecological issues with a sense of urgency. My research offers a strategy for developing ecological thinking through attentive observation and may be positioned to contribute to these imperatives. Cultivating ecological thinking 'carries with it a large measure of responsibility',<sup>617</sup> as

.....

616 Ingold, 'Search and Search Again', 2018, 37:18.

617 Patrizio, 2019, p. 65.

recognising every small action as a systemically entwined contribution to a greater ecology demands new behaviour. The Gibsonian research framework I have proposed may provide a structure to support this transformation.

In presenting this thesis, I follow in Gibson's ecological footsteps, and I hope, as I am certain Gibson once hoped, my these words might contribute a genuine change.

'There is only one world, however diverse, and all animals live in it, although we human animals have altered it to suit ourselves. We have done so wastefully, thoughtlessly, and, if we do not mend our ways, fatally'.<sup>618</sup>

*Taking the Long View* has been a long road, a winding path, and a pilgrimage of sorts, with all the incumbent challenges such a journey entails. This research was an education of attention which afforded a multiplicity of new perspectives - perceptual, artistic, intellectual, conceptual, spatial, temporal and ecological. In *Taking the Long View*, attending to light became synonymous with being; perceptual awareness expanded; new knowledge was acquired; the light-perceiver-environment nexus emerged as an ecological continuum; an ecological worldview was cultivated, and states of becoming served as reminders to remain humble. That is the ecological nature of light.

'We shall not cease from exploration and the end of all our exploring will be to arrive where we started and know the place for the first time'.<sup>619</sup>

*Et sic in infinitum...*

.....  
618 Gibson, 1979, p.130.

619 Eliot, T.S. 'Little Gidding', in: *Four Quartets* (New York, NY: Harcourt, 1941) <<http://www.columbia.edu/itc/history/winter/w3206/edit/tseliotlittlegidding.html>> [accessed 4 December 2015]

## Bibliography

Anderson, Joseph D., *The Reality of Illusion: An Ecological Approach to Cognitive Film Theory* (Carbondale and Edwardsville, IL: Southern Illinois University Press, 1996)

Anon. Review of 'Catching the Light', by Arthur Zajonc, *Kirkus Reviews*, November (1992) [Online] Available from: <<https://www.kirkusreviews.com/book-reviews/arthur-zajonc/catching-the-light/>> [accessed 3 October 2017]

Armstrong, Keith, 'Sustaining the Sustainable? Developing a Practice and Problem-Led New Media Praxis', in *Practice-Led Research, Research-Led Practice in the Creative Arts*, ed. by Hazel Smith and Roger T. Dean, (Edinburgh: Edinburgh University Press, 2009), pp. 187–99

Ascott, Roy, 'Syncretic Reality: Art, Process, and Potentiality', *Drain*, 2.2 (2005) <[https://www.academia.edu/2590161/Syncretic\\_Reality\\_art\\_process\\_and\\_potentiality](https://www.academia.edu/2590161/Syncretic_Reality_art_process_and_potentiality)> [accessed 7 January 2019]

*Archaeologies of Presence*, ed. by Gabriella Giannachi, Nick Kaye, and Michael Shanks (Abingdon: Routledge, 2012)

Arlander, Annette, 'Artistic Research and/as Interdisciplinarity', *Artistic Research Does*, 1, 2016, 1–5

Ash, Mitchell G., and Thomas J. Lombardo, 'The Reciprocity of Perceiver and Environment: The Evolution of James J. Gibson's Ecological Psychology', *The American Journal of Psychology*, 103.1 (1990), 127-132

Barad, Karen, *Meeting the Universe Halfway* (Durham, NC: Duke University Press, 2007)

Barrett, Estelle, and Barbara Bolt, *Practice as Research: Approaches to Creative Arts Enquiry* (London: I B Tauris, 2010)

Bateson, Gregory, *Steps to an Ecology of Mind: Collected Essays in Anthropology, Psychiatry, Evolution, and Epistemology* (Chicago, IL: University of Chicago Press, 1972)

Benson, Michael, *Cosmographics: Picturing Space Through Time*, (New York, NY: Abrams, 2014)

Berger, John, et al., *Ways of Seeing* (London: British Broadcasting Corporation: Penguin Books, 1973)

Braund, Michael James, 'The Structures of Perception: An Ecological Perspective', *Kritike : An Online Journal of Philosophy*, 2. 1.3 (2008), 123–44

Brown, Rebekah R., Ana Deletic, and Tony H. F. Wong, 'Interdisciplinarity: How to Catalyse Collaboration', *Nature News*, 525.7569 (2015), 315 [Online] Available from: <<https://doi.org/10.1038/525315a>>

Bryson, Norman, 'The Gaze in the Expanded Field', in *Vision and Visuality*, ed. by Hal Foster (Seattle, WA: Bay Press, 1988). pp.98-99

Buchanan, Richard, 'Design Research and the New Learning', *Design Issues*, 17.4 (2001), 3–23 <<https://doi.org/10.1162/07479360152681056>> [accessed 26 April 2018]

Burnham, Jack, *Beyond Modern Sculpture: The Effects of Science and Technology on the Sculpture of This Century* (New York, NY: George Braziller, 1975)

Costall, Alan, 'Canonical Affordances in Context' 2012, *Avant: Trends in Interdisciplinary Studies* 3 (2), (2012) 85-93

Cubitt, Sean, *The Practice of Light*, Leonardo Book Series (Cambridge, MA: MIT Press, 2014)

Culpepper, Mary, 'I Make, Therefore I Am: Agency, Action, Affordance, and the Path to Creative Identity' (unpublished PhD Thesis, University of Westminster, 2018)

Curran, Fiona, 'Towards a Fractured Topography of the Present: Art, Ecology and the Political Economy of Speed' (unpublished Doctoral thesis, University College London, 2016)

Davies, Charlotte, 'Landscapes of Ephemeral Embrace : A Painter's Exploration of Immersive Virtual Space as a Medium for Transforming Perception' (unpublished PhD Thesis, University of Plymouth, 2005)

DeLanda, Manuel, 'Ecology and Realist Ontology', in *Deleuze/Guattari & Ecology*, ed. by Bernd Herzogenrath (New York: Palgrave Macmillan, 2009), pp. 23–41

Demos, T.J., *Decolonizing Nature: Contemporary Art and the Politics of Ecology* (Berlin: Sternberg Press, 2016)

Dick, Bob in 'Action Research and the Practice of Design', *Design Issues*, 18.1 by Cal Swann (2002), 49–61, p. 56. <<https://doi.org/10.1162/07479360252756287>> [accessed 12 June 2018]

Dickinson, Emily, 'There's a Certain Slant of Light' [1890], in *A Choice of Emily Dickinson's Verse* selected and with an introduction by Ted Hughes (London: Faber and Faber, 1986).

Dobromir, G., Lin Nie Dotov and Matthieu M. De Wit, 'Understanding Affordances: History and Contemporary Development of Gibson's Central Concept', *Avant: Journal of Philosophical-Interdisciplinary Vanguard*, 3.2 (2012), 28–39

Dubberly, Hugh, and Paul Pangaro, 'How Cybernetics Connects Computing, Counterculture, and Design', in *Hippie Modernism: the Struggle for Utopia*, exh. cat. (Minneapolis, MN: Walker Art Center, 2015), 1–12

'Ecological Perception', in: *American Psychology Association Dictionary of Psychology*, [Online] Available from: <<https://dictionary.apa.org/direct-perception> & <https://dictionary.apa.org/ecological-perception>> [accessed 15 April 2016]

Edgerton, Samuel Y., review of 'The Senses Considered as Perceptual Systems', by James J. Gibson, *The Art Bulletin*, 51 (1969), 310–11

Eliot, T.S. 'Little Gidding', in: *Four Quartets* (New York: Harcourt, 1941).

.....  
*Experience*, ed. by Caroline A. Jones, David Mather, and Rebecca Uchill (Cambridge, MA: MIT Press, 2016)

Feldman, Melissa E., *Another Minimalism*, exh. cat. (Edinburgh: The Fruitmarket Gallery, 2015)

Ferguson, Russell, 'Into Thin Air', in *Uta Barth: In Between Places*, ed. by Sheryl Conkelton, exh.cat. (Seattle, WA: Henry Gallery Association, 2001)

Flach, John M., and John G. Holden, 'The Reality of Experience: Gibson's Way', *Presence*, 7.1 (1998), 90–95

Fludd, Robert, *Utriusque Cosmi*, 1617 [Online] Available from: <<https://ia801406.us.archive.org/16/items/utrusquecosmima01flud/utrusquecosmima01flud.pdf>> [accessed 22 March 2017]

Fodor, J.A., and Z.W. Pylyshyn, 'How Direct Is Visual Perception? Some Reflections on Gibson's "Ecological Approach"', *Cognition*, 9 (1981), 139–96

Fredericksen, Don, 'Review of "The Reality of Illusion: An Ecological Approach to Cognitive Film Theory"', by Joseph. D. Anderson, *Journal of Film and Video*, 51.3–4 (1999), 97–99

French, Michaela, 'An Emerging Spherical Infinity', in: *The New Infinity: Visual Art and Music in Planetariums*, ed. by Thomas Oberender, Berliner Festspiele (Köln: Buchhandlung Walther König, 2019), 64-66

Frodeman, Robert, *Sustainable Knowledge - A Theory of Interdisciplinarity* (Basingstoke: Palgrave Macmillan, 2014)

Gaver, William, 'Technology Affordances', in *Proceedings of the CHI, 1991* (New York: ACM,1991), pp. 79-84

Gibson, James J., *The Senses Considered as Perceptual Systems* (Boston: Houghton Mifflin Company, 1966)

-----, *The Ecological Approach to Visual Perception* (New York: Taylor and Francis, 1979)

-----, 'A Theory of Direct Visual Perception' [1972], in *Vision and Mind*, ed. by Alva Noë and Evan Thompson (Cambridge, MA: MIT Press, 2002), pp. 77-89, p. 84.

Gibson, James J., and Eleanor J. Gibson, 'Perceptual Learning: Differentiation or Enrichment?', *Psychological Review*, 62 (1955), 32–41

Gombrich, Ernst. H., 'Distinguished Dissident: Review of "James J. Gibson and the Psychology of Perception" by Edward S. Reed', *New York Review of Books* (January 1989), 13–15

Goodbun, Jon, 'The Architecture of the Extended Mind: Towards a Critical Urban Ecology' (unpublished PhD Thesis, University of Westminster, 2011)

-----, 'An Ecology of Mind', *The Architectural Review* (27 March 2012)  
[Online] Available from: <<https://www.architectural-review.com/rethink/an-ecology-of-mind/8628251.article>> [accessed 22 February 2017]

-----, 'Steps to an Ecological Aesthetic in the Atacama', *Rheomode*, 2018  
[Online] Available from: <<https://jongoodbun.wordpress.com/2018/04/01/steps-to-an-ecological-aesthetic-in-the-atacama/>> [accessed 3 May 2018]

Goodyear, Anne Collins, 'György Kepes, Billy Klüver, and American Art of the 1960s: Defining Attitudes Toward Science and Technology', *Science in Context*, 17.4 (2004), 611–35

Grandy, David A., *The Speed of Light: Constancy and Cosmos* (Bloomington, IN: Indiana University Press, 2009)

Gray, Carole, and Julian Malins, *Visualizing Research: A Guide to the Research Process in Art and Design* (Aldershot; Burlington, VT: Routledge, 2004)

Greenwood, Davydd J., 'Evolutionary Systems Thinking: What Gregory Bateson, Kurt Lewin, and Jacob Moreno Offered to Action Research That Still Remains to Be Learned', in *The SAGE Handbook of Action Research*, ed. by Hilary Bradbury (London: SAGE Publications Ltd, 2015), pp. 425–33

Griffin, Susan, 'Ecofeminism and Meaning', in *Ecofeminism: Women, Culture, Nature*, edited by Karen Warren. Bloomington, IN: Indiana University Press, 1997.

Grosseteste, Robert, *On Light* (De Luce), trans. by Clare C Riedl (Milwaukee, WI: Marquette University Press, 1942)

'György Kepes Papers', MIT-ACT (Art, Culture and Technology) [Online] Available from: <<http://act.mit.edu/collections/visionandvalue/>> [accessed 11 July 2018]

Haber, Ralph Norman, 'A Theory of Perception', *Science* (Book Reviews), 209.4458 (1980), 799–800

-----, 'Perception: A One Hundred Year Perspective', in *Perception: a One Hundred Year Perspective*, ed. by Sigmund Koch and David E. Leary (Washington, DC: American Psychological Association, 1985)

Haraway, Donna J., *The Companion Species Manifesto* (Chicago, IL: University of Chicago Press, 2003).

Haeckel, Ernst, *Generelle Morphologie der Organismen: Allgemeine Grundzüge der Organischen Formen; Wissenschaft, Mechanisch Begründet durch die von Charles Darwin Reformierte Deszendenz-Theorie* (Berlin: G. Reimer, 1866)

Harries-Jones, Peter, *A Recursive Vision Ecological Understanding and Gregory Bateson* (Toronto: University of Toronto Press, 1995)

-----, 'Gregory Bateson and Ecological Aesthetics: An Introduction', *Australian Humanities Review*, 6.1 (2005) [Online] Available from: <<http://australianhumanitiesreview.org/2005/06/01/gregory-bateson-and-ecological-aesthetics-an-introduction/>> [accessed 1 September 2019]

-----, 'Gregory Bateson's 'Uncovery' of Ecological Aesthetics', in *A Legacy for Living Systems*, ed. by Jesper Hoffmeyer (Dordrecht: Springer International Publishing, 2008), pp. 153–67

Heft, Harry, *Ecological Psychology in Context: James Gibson, Roger Barker, and the Legacy of William James's Radical Empiricism Resources for Ecological Psychology* (Mahwah, NJ: Lawrence Erlbaum Associates, 2001)

-----, 'An Ecological Approach to Psychology', *Review of General Psychology*, 17.2 (2013), 162–67

Heidegger, Martin, *Being and Time* [1927] (New York, NY, USA: Harper & Row, 1962

'Holistic', *Oxford Dictionary of English*, ed. by Angus Stevenson (Oxford University Press, 2010), [Online] Available from: <<https://www.oxfordreference.com/view/10.1093/acref/9780199571123.001.0001/acref-9780199571123>> [accessed 12 November 2019]

Hopfinger, Sarah, 'Performance (in) Ecology: A Practice-Based Approach' (unpublished PhD Thesis, University of Glasgow, 2017)

Ingold, Tim, 'Culture and the Perception of the Environment', in *Bush Base: Forest Farm: Culture, Environment, and Development*, ed. by David J. Parkin and Elisabeth Croll (London ; New York: Routledge, 1992), pp. 39–56

-----, *The Perception of the Environment* (London: Routledge, 2000)

-----, 'Materials against Materiality', *Archaeological Dialogues*, 14.1 (2007), 1–16

-----, *Being Alive* (London: Routledge, 2011)

-----, 'The Maze and the Labyrinth: Walking and the Education of Attention', in *Walk-On*, ed. by Mike Collier and Cynthia Morrison-Bell, exh. cat. (Sunderland: Art Editions North, University of Sunderland, 2013). pp.14-19

-----, *Making* (London: Routledge, 2013)

-----, *Correspondences* (Aberdeen: University of Aberdeen, 2017)

-----, 'From Science to Art and Back Again: The Pendulum of an Anthropologist', *Interdisciplinary Science Reviews*, 43.3–4 (2018)

-----, 'Search and Search Again: On the Meaning of Research in Art' (Centre for Contemporary Arts, Glasgow UK, 4 February 2018)

-----, 'Back to the Future with the Theory of Affordances', *HAU: Journal of Ethnographic Theory*, 8.1–2 (2018), 39–44

Jenkins, Harold, 'Gibson's "Affordances": Evolution of a Pivotal Concept', *Journal of Scientific Psychology* (December 2008), 34-45

Jones, Caroline A., 'Modeling', in *Experience*, ed. by Caroline A. Jones, David Mather, and Rebecca Uchill (Cambridge: MIT Press, 2016), pp. 13–33

-----, 'Jack Burnham's "Systems Esthetics"', *Artforum*, September 2012 [Online] Available from <<https://www.artforum.com/print/201207/caroline-a-jones-on-jack-burnham-s-systems-esthetics-32014>> [accessed 2 November 2018].

-----, 'In reference to James J. Gibson', 9th July 2019, (personal email).

**Karanika, Myrto**, 'Exploring Perceptual Matters - a Textile-Based Approach' (unpublished PhD Thesis, Royal College of Art, 2013)

**Kasschau, Richard A.**, *Psychology : Exploring Behavior* (Englewood Cliffs, NJ: Prentice-Hall, 1980)

**Kemmis, Stephen**, 'Action Research in Retrospect and Prospect' (presented at the Annual Meeting of the Australian Association for Research in Education, Melbourne, Australia, November 1980) [Online] Available from: <<https://files.eric.ed.gov/fulltext/ED200560.pdf>> [accessed 2 November 2019].

**Kemmis, Stephen**, and Wilfred Carr, *Becoming Critical: Education Knowledge and Action Research* (London ; Philadelphia, PA: Routledge, 1986)

**Kensler, Gordon L.**, 'Review of "The Senses Considered as Perceptual Systems", by James J. Gibson, *Studies in Art Education*, 10.3 (1969), 63–64

**Kepes, György**, *The Language of Vision* (Chicago, IL: Theobald, 1944)

**Kilbourne, Kyle**, and **Jessica Isaksson**, 'Meaning through Doing: The Role of Affordances over Time', *Sixth Nordcode Seminar & Workshop: Design Semiotics in Use* (Helsinki, Finland: University of Art and Design, 2007)

**King, Elaine A.**, 'Into the Light: a Conversation with James Turrell', *Sculpture*, 21.9 (2002) [Online] Available from: <<https://www.sculpture.org/documents/scmag02/nov02/turrell/turrell.shtml>> [accessed 2 September 2017].

**Klein, Julian**, 'Seven Answers to the Situation of the Field of Artistic Research', in *Futures of Artistic Research: At the Intersection of Utopia, Academia and Power*, ed. by Jan Kaila, Anita Seppä, and Henk Slager (Grano Oy, Finland: The Academy of Fine Arts, Uniarts Helsinki, 2017), pp. 55–60

-----, 'What Is Artistic Research?', *Journal for Artistic Research*, 2017 [Online] Available from: <<http://jar-online.net/what-artistic-research>> [accessed 10 December 2018].

**Kobayashi, Masaki**, **Daisuke Kikuchi**, and **Hitoshi Okamura**, 'Imaging of Ultraweak Spontaneous Photon Emission from Human Body Displaying Diurnal Rhythm.', *PLoS ONE* 4.7 (2009) E6256. Doi:10.1371/Journal.Pone.0006256 [Online] Available from: <<http://www.plosone.org/article/fetchObject.action?uri=info:doi/10.1371/journal.pone.0006256&representation=PDF>> [accessed 3 April 2015]

**Lewin, Kurt**, 'Psychological Ecology' [1943], in *The People, Place, and Space Reader*, ed. by William Mangold et al. (New York, NY: Routledge, 2014), pp.17-21

-----, 'Action Research and Minority Problems', *Journal of Social Issues*, 2 (1946), 34–46

-----, 'Field Theory in Social Science; Selected Theoretical Papers', ed. by Dorwin Cartwright, *The Annals of the American Academy of Political and Social Science*, 276.1 (1951), 146–47

'Light' *Oxford Reference*, [Online] Available from: <[https://www.oxfordreference.com/view/10.1093/acref/9780199571123.001.0001/m\\_en\\_gb0470230](https://www.oxfordreference.com/view/10.1093/acref/9780199571123.001.0001/m_en_gb0470230)> [accessed 1 July 2019]

**Lobo, Lorena**, **Manuel Heras-Escribano**, and **David Travieso**, 'The History and Philosophy of Ecological Psychology', *Frontiers in Psychology*, 9 (2018), pp. 22-28.

**Mace, William M.**, 'Introduction', in James J. Gibson, *The Ecological Approach to Visual Perception* (New York, London: Routledge, 2014)

**Mackay, Robin**, 'Approaching the Contemporary Object', Keynote Address, *Humanities and Beyond: Exploring the Frontiers of Interdisciplinarity*, (York UK: University of York, 27th May 2016)

**McConville, David**, 'On the Evolution of the Heavenly Spheres' (unpublished PhD Thesis, Plymouth University, 2014)

**Mead, Margaret**, Cybernetics of Cybernetics in H. Von Foerster, J.D. White, L.J. Peterson, and J.K. Russell, (eds), *Purposive Systems*, (New York, Spartan Books: 1968), pp.1-19

**Merleau-Ponty, Maurice**, *Phenomenology of Perception* [1962] (London: Routledge & Kegan Paul, 2005)

-----, 'The Eye and the Mind', in *The Primacy of Perception: and Other Essays on Phenomenological Psychology* (Evanston, IL: Northwestern University Press, 1964)

NASA 'The Electromagnetic Spectrum', *Imagine the Universe*, (2016) [Online] Available from: <<http://imagine.gsfc.nasa.gov/science/toolbox/emspectrum2.html>> [Accessed 22 March 2017]

NASA, *Hubble Ultra Deep Field 2014*. [Online] Available from: <<https://hubblesite.org/image/3380/gallery/58-hubble-ultra-deep-field>> [accessed 22 March 2017]

**Natsoulas, Thomas**, 'Perceiving, Its Component Stream of Perceptual Experience, and Gibson's Ecological Approach', *Psychological Research*, 55 (1993), pp. 248–57

**Nelson, Robin**, *Practice as Research in the Arts* (London: Palgrave Macmillan, 2013)

Newman, Rob, 'Steller's Sea Cow', *The Extinction Tapes*, episode 4, BBC Radio 4, broadcast 7 November 2019 [Online] Available from: <<https://www.bbc.co.uk/sounds/play/m0009yxc>> [accessed 19 November 2019]

Noë, Alva, *Varieties of Presence* (Cambridge, MA: Harvard University Press, 2012)

Nolan, Lucille, 'Vision Science and the Visual Arts' (unpublished PhD Thesis, Northumbria University, 2008)

Norman, Donald, 'Affordance, Conventions and Design (Part 2)', *Jnd.Org*, 2008 [Online] Available from: <[https://jnd.org/affordance\\_conventions\\_and\\_design\\_part\\_2/](https://jnd.org/affordance_conventions_and_design_part_2/)> [accessed 15 July 2019]

-----, *The Design of Everyday Things*, rev. and expanded edn. (New York, NY: Basic Books, 2013)

Norman, Joel, 'Two Visual Systems and Two Theories of Perception: An Attempt to Reconcile the Constructivist and Ecological Approaches', *Behavioral and Brain Sciences*, 25.1 (2002), 73–96 <<https://doi.org/10.1017/S0140525X0200002X>>.

Palmer, James M., 'The Measurement of Transmission, Absorption, Emission and Reflection', in *Handbook of Optics: Fundamentals, Techniques, and Design*, ed. by Michael Bass (McGraw-Hill, 1994), pp. 1-25

O'Riley, Tim, 'A Discrete Continuity: On the Relation between Research and Art Practice', *Journal of Research Practice*, 7.1 (2011)

Oster, Gerald, review of Review of 'The Senses Considered as Perceptual Systems', by James J. Gibson, *Leonardo*, 1.1 (1968), 89–90 <<https://doi.org/10.2307/1571911>>.

Pask, Gordon, *Philosopher Mechanic: An Introduction to the Cybernetician's Cybernetician*, ed. Ranulph Glanville and Karl H. Müller, (Vienna: Edition Echoraum, 2007)

Patrizio, Andrew, *The Ecological Eye: Assembling an Ecocritical Art History* (Rethinking Art's Histories) (Manchester: Manchester University Press, 2019)

Pick, Herbert L., 'Eleanor J. Gibson: Learning to Perceive and Perceiving to Learn', *Developmental Psychology*, 28.5 (1992), 787–94

'Quantum'. *Oxford Dictionary* [Online] Available from: <<https://en.oxforddictionaries.com/definition/quantum>> [Accessed 09/12/2016]

Reed, Edward S., *James J. Gibson and the Psychology of Perception* (New Haven, CT: Yale University Press, 1988)

Reeve, Sandra, 'The Ecological Body' (unpublished PhD Thesis, University of Exeter, 2008)

Richards, Robert J., *The Tragic Sense of Life* (Chicago, IL; London: The University of Chicago Press, 2008)

Rikou, Elpida and Yalouri, Eleana, 'The Art of Research Practices Between Art and Anthropology', *Field Journal*, 11, 2018 [Online] Available from: <<http://field-journal.com/editorial/introduction-the-art-of-research-practices-between-art-and-anthropology>> [accessed 19 February 2019].

Riley, Howard, 'Drawing as Language: The Systemic-Functional Semiotic Argument', *Journal of Visual Art Practice*, 18.2 (2019)

Rodgers, Paul and Craig Bremner, 'Alterplarity - "Alternative Disciplinarity" in Future Art and Design Research Pursuits', *Studies in Material Thinking*, 6 (2011) [Online] Available from: <<https://www.materialthinking.org/papers/64>> [accessed 11 December 2018].

'Roger Ackling', Artist profile, *Annely Juda Fine Art* [Online] Available from: <<http://www.annelyjudafineart.co.uk/artists/roger-ackling>> [accessed 3 February 2019]

'Roger Ackling: Brought to Light' (2018), Exhibitions, *Annely Juda Fine Art* [Online] Available from: <<http://www.annelyjudafineart.co.uk/exhibitions/brought-to-light-roger-ackling>> [accessed 3 February 2019]

Ruspini, Elisabetta, *An Introduction to Longitudinal Research* (London: Routledge, 2003).

Savage, C. Wade, 'Gibson's Reasons for Realism', *Cognitive Critique*, 4 (2011), 14 <[http://www.cogcrit.umn.edu/docs/Savage\\_11.pdf](http://www.cogcrit.umn.edu/docs/Savage_11.pdf)> [accessed 7 May 2018]

Schön, Donald, *The Reflective Practitioner: How Professionals Think in Action* (New York: Basic Books, 1984)

Scott, Bernard, "The Cybernetics of Gordon Pask," in Gordon Pask, *Philosopher Mechanic: An Introduction to the Cybernetician's Cybernetician*, ed. Ranulph Glanville and Karl H. Müller, (Vienna: Edition Echoraum, 2007)

Searle, Adrian, 'How the Hayward Gallery's Light Show Monkeys with Your Eyeballs', *Guardian*, 28 January 2013 [Online] Available from: <<https://www.theguardian.com/artanddesign/2013/jan/28/hayward-gallery-light-show-exhibition>> [accessed 15 March 2016]

Sencindiver, Susan Yi, 'New Materialism', *Oxford Bibliographies*, 2017 [Online] Available from: <<https://www.oxfordbibliographies.com/view/document/obo-9780190221911/obo-9780190221911-0016.xml>>

Shepard, Paul, *Man in the Landscape: A Historic View of the Esthetics of Nature* (New York, NY: Knopf, 1967)

*Sign, Image, Symbol, (Vision + Value, 6)*, ed. by György Kepes, (London: Studio Vista, 1966)

**Simon, Herbert A.**, *Designing Organizations for an Information-Rich World* (Baltimore, MD: Johns Hopkins University Press, 1971)

**Sjölin, Anders**, 'Plastic Modes of Listening: Affordance in Constructed Sound Environments' (unpublished PhD Thesis, University of Westminster, 2011)

**Smith, David Woodruff**, 'Phenomenology', *The Stanford Encyclopedia of Philosophy* (Summer 2018), Edward N. Zalta (ed.)

**Steer, John**, 'Art History and Direct Perception: A General View', *Art History*, 12.1 (1989), 93–108

**Sun, Yan, Chao Wang and Jiawei Dai**, 'Biophotons as Neural Communication Signals Demonstrated by in Situ Biophoton Autography', *Photochem. Photobiol. Sci.*, 9.3 (March 2010)

'Sunrise & Sunset Times', *UK Weathercams* [Online] Available from: <<https://www.ukweathercams.co.uk/>> [accessed December 2015 - December 2016]

**Swann, Cal**, 'Action Research and the Practice of Design', *Design Issues*, 18.1 (2002), 49–61, p. 56. <<https://doi.org/10.1162/07479360252756287>> [accessed 12 June 2018]

**Tassie, Whitney**, in Claire Voon, 'A Pastel Portrait of Spiral Jetty and Its Environs', *Hyperallergic* (23 November 2017) [Online] Available from: <<https://hyperallergic.com/398186/a-pastel-portrait-of-spiral-jetty-and-its-environs/>> [accessed 27 August 2019]

**Terranova, Charissa N.**, 'Operational Blindness in the Twentieth Century: The Emerging Digital Image in Art from Gestalt to Distributed Network' presented at the *RENEW: Digital Arts Festival and Conference* (Copenhagen, Denmark, 2013)

-----, *Art as Organism: Biology and the Evolution of the Digital Image* (London: Bloomsbury Academic, 2016)

**Thomas, David R.**, 'A General Inductive Approach for Analyzing Qualitative Evaluation Data', *American Journal of Evaluation*, 27.2 (2006), 237–246

**Turrell, James**, 'Introduction', *James Turrell* [Online] Available from: <<http://jamesturrell.com/about/introduction/>> [accessed 2 September 2017] (para. 6 of 6)

'Two Correlated Rotations', Dan Graham, 1970–72, *Tate* [Online] Available from: <<https://www.tate.org.uk/art/artworks/graham-two-correlated-rotations-t01737>> [accessed 2 October 2018]

'Types of Twilight', *Timeanddate.com*, 2016 [Online] Available from: <<https://www.timeanddate.com/astronomy/different-types-twilight.html>> [accessed December 2015 - December 2016]

**Ullman, Shimon**, 'Against Direct Perception', *Behavioural and Brain Sciences*, 3.3 (1980), 373–415

**Varela, Francisco**, 'Introduction' in Heinz von Foerster, *Observing Systems: Selected papers by Heinz von Foerster*, ed. by F. Varela, (Santa Barbara, CA: Intersystems Publications, 1982)

**Varela, Francisco J., Evan Thompson and Eleanor Rosch**, *The Embodied Mind* (Cambridge: MIT Press, 1993).

*Vision + Value*, 7 volumes, ed. by György Kepes, (New York, NY: George Braziller, 1965–72)

**Walker, Kevin**, 'A Systems Approach to Design Innovation' presented at *To Get There: Designing Together*, (Paris, France: Cumulus International Association of Universities and Colleges of Art, Design and Media, 2018) <https://www.cumulusassociation.org/cumulus-conference-paris-2018-to-get-there/>

-----, 'Experience beyond Humans', Keynote Address, LDoc at London Design Festival: Design Research Evolution (London: Royal College of Art, 20 September 2018) <http://ldoc-cdt.ac.uk/ldoc-at-ldf-design-research-evolution/>

-----, 'Investigative Design: Materiality, Systems, Critique' presented at *Beyond Change: Questioning the Role of Design in Times of Global Transformations*, (Basel, Switzerland: Swiss Design Network Research Summit, 2018)

**Watson, Bruce**, *Light: a Radiant History from Creation to the Quantum Age* (New York, NY: Bloomsbury, 2016) pp. 175–192

**Windsor, W. Luke, and Christophe de Bézenac**, 'Music and Affordances', *Musicae Scientiae*, 16.1 (2012), 102–20 [Online] Available from: <<https://doi.org/10.1177/1029864911435734>>

**Withagen, Rob, and John van der Kamp**, 'An Ecological Approach to Creativity in Making', *New Ideas in Psychology*, 49 (April 2018), 1–6

**Zahoric, Pavel, and Rick L. Jenison**, 'Presence as Being in the World', *Presence*, 7. 1 (1998), 78–89

**Zajonc, Arthur**, *Catching the Light: The Entwined History of Light and Mind* (New York: Oxford University Press, 1995)





# Appendix

An Ecological Approach

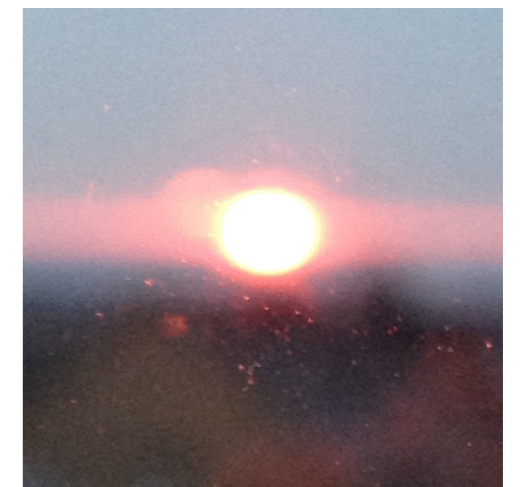
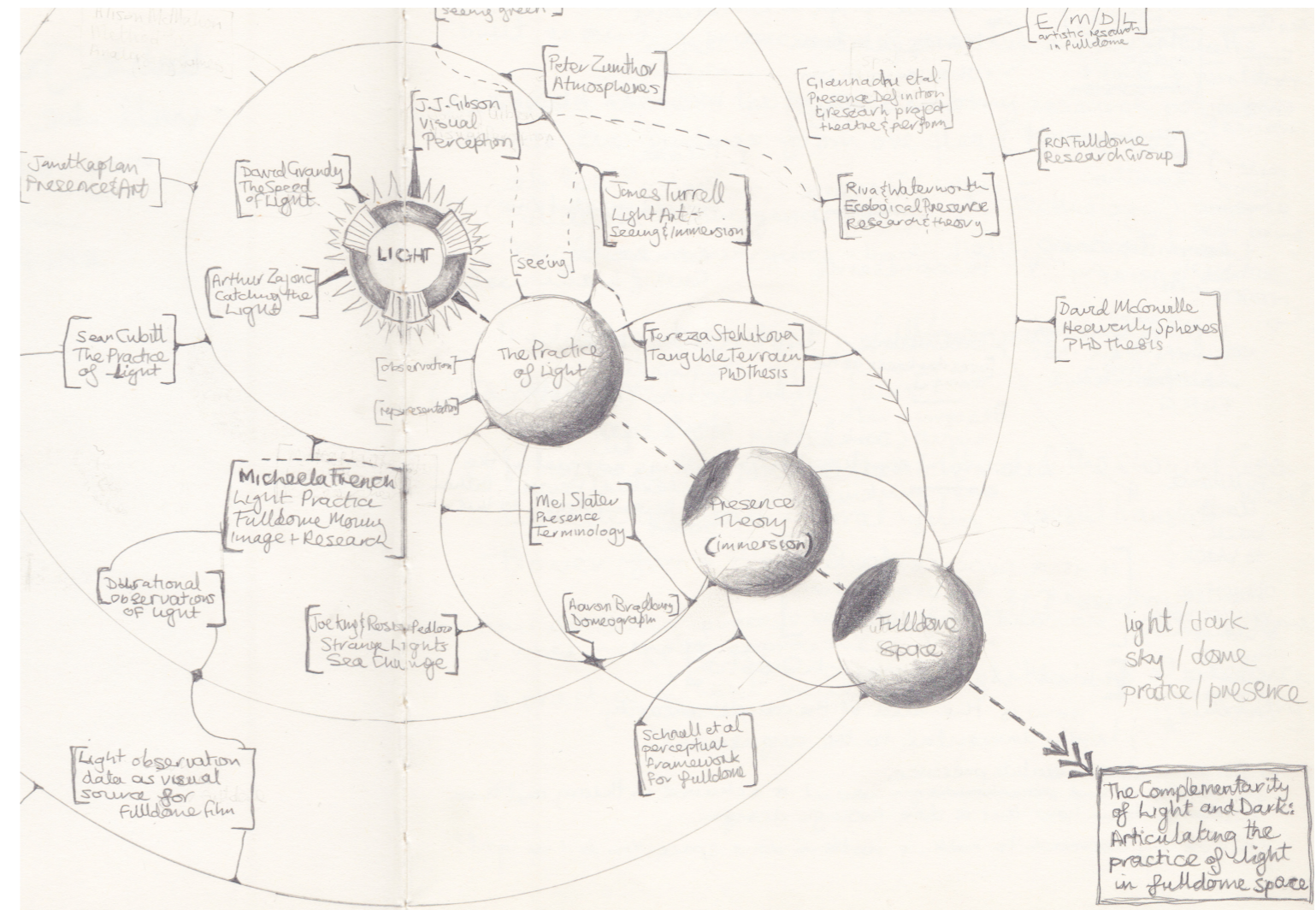

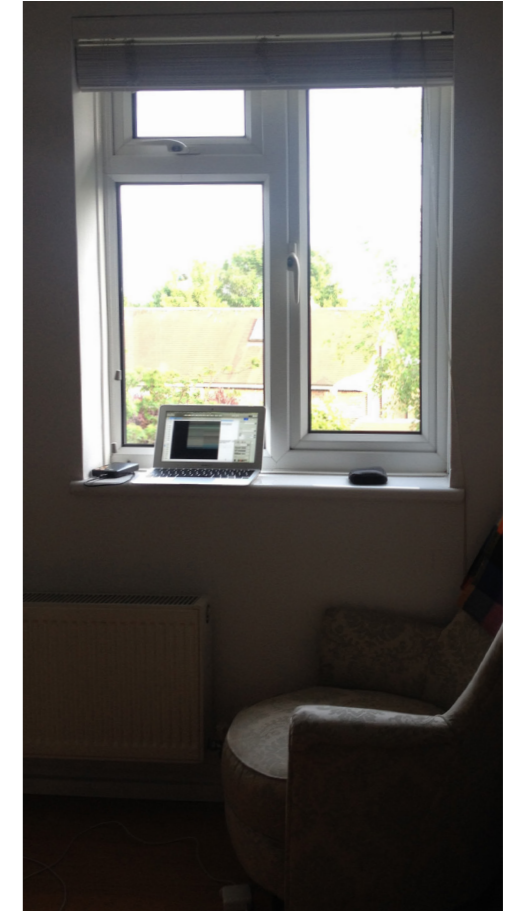
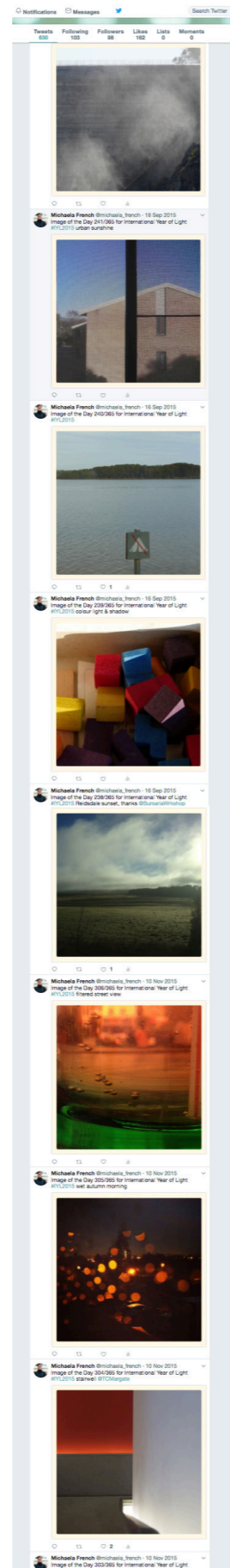

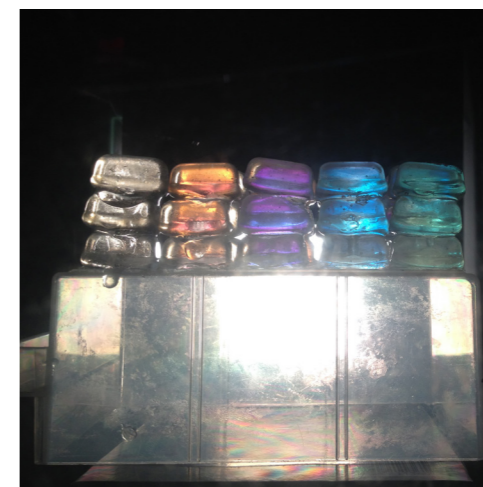

breathing/spinning  
 ↓  
 presence



practice as a means of explanation of the theory  
 what needs to be unpacked or thing at a time  
 - practice & theoretical context need to start writing...

July 21st 2017  
 Tim Ingold on Globes & Spheres.

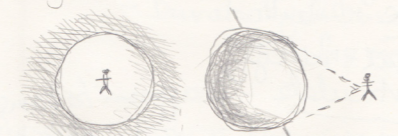

<b>Sphere</b>	<b>Globe</b>
- environment	- global
- in/being	- on/viewing
- ecological (Gibson)	- cartesian
- ego centre	- exocentric
- fulsome	- VR

- Notes to send to Kevin with draft

substance	○	○	○	○	matter
quality	○	○	○	○	
quantity	○	○	○	○	
locomotion	○	○	○	○	
	emission	absorption	transmission	reflection	

- think about taxonomy

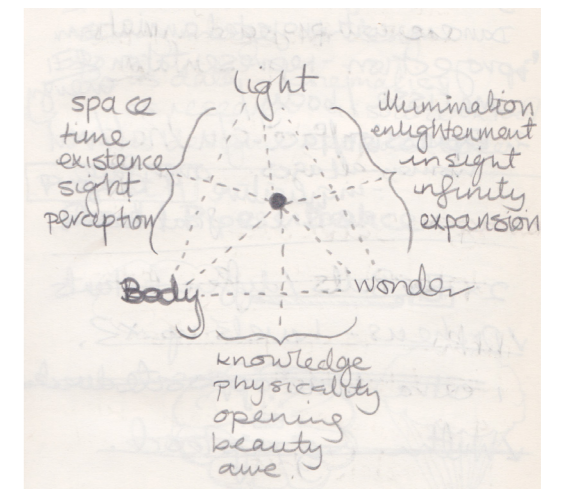
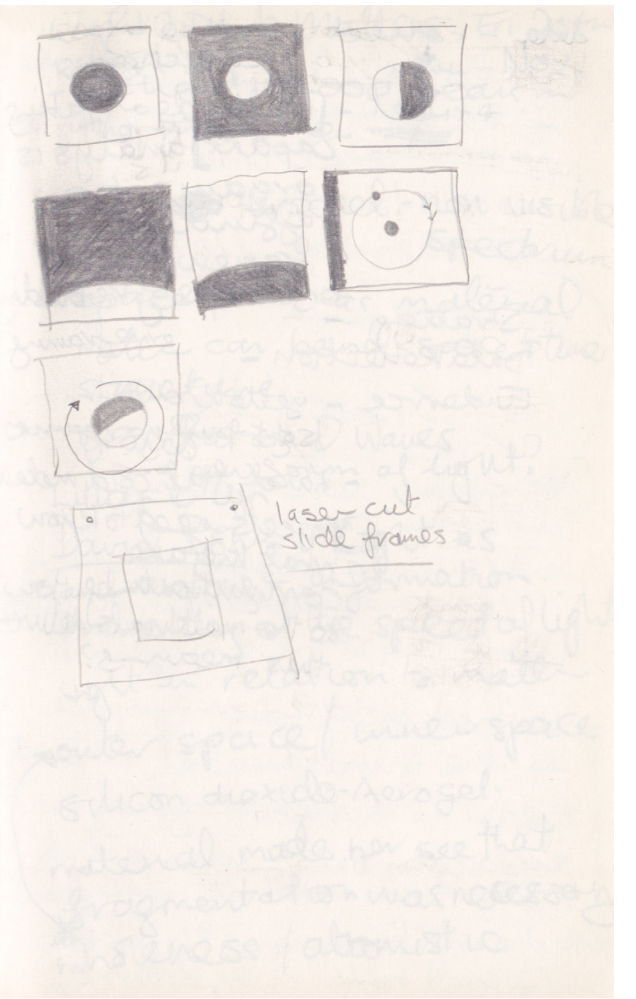
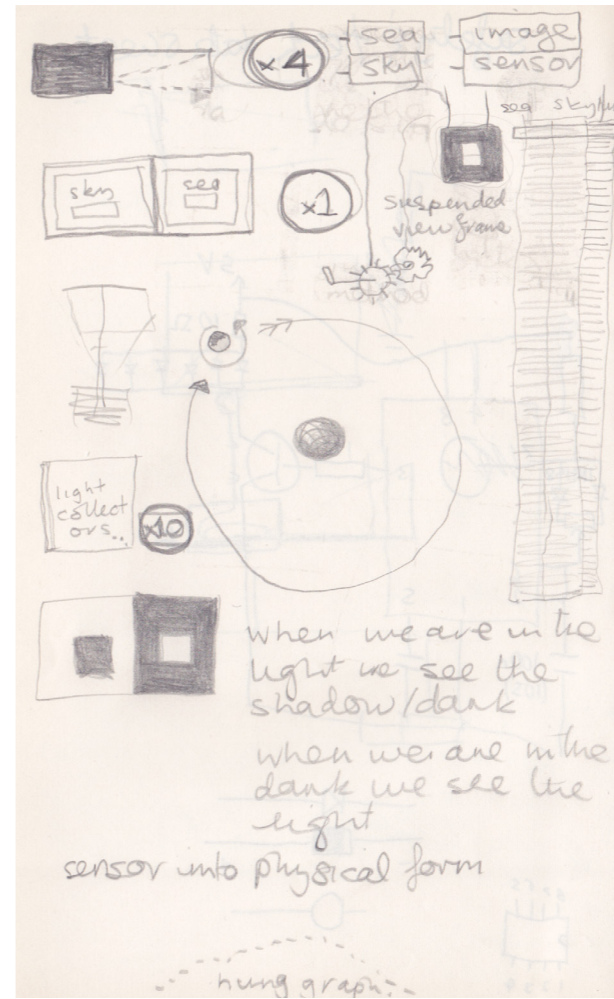

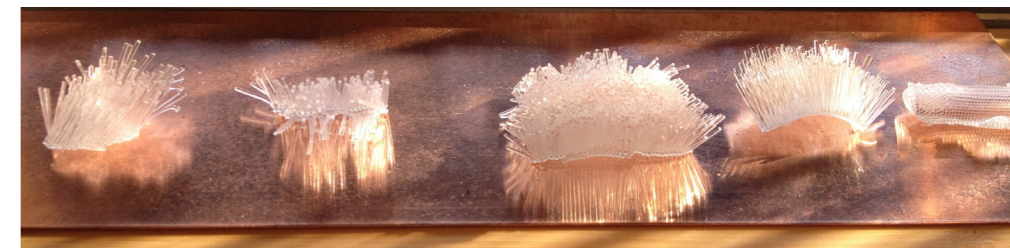

LIGHT IN ART - T. B. HESS 701-8 LIG



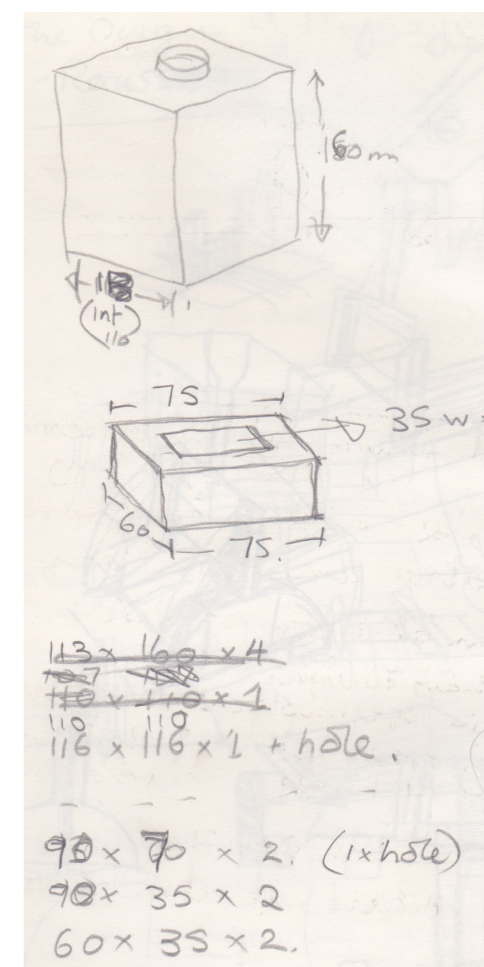
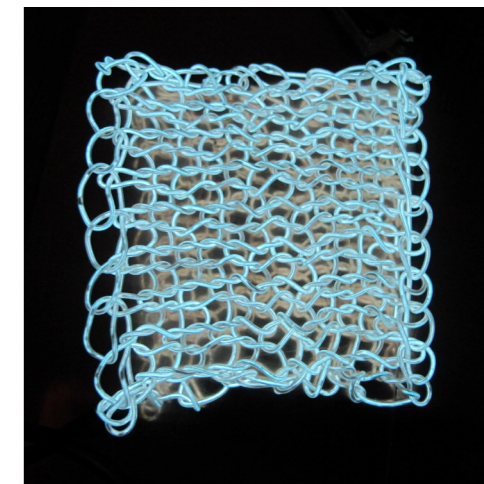

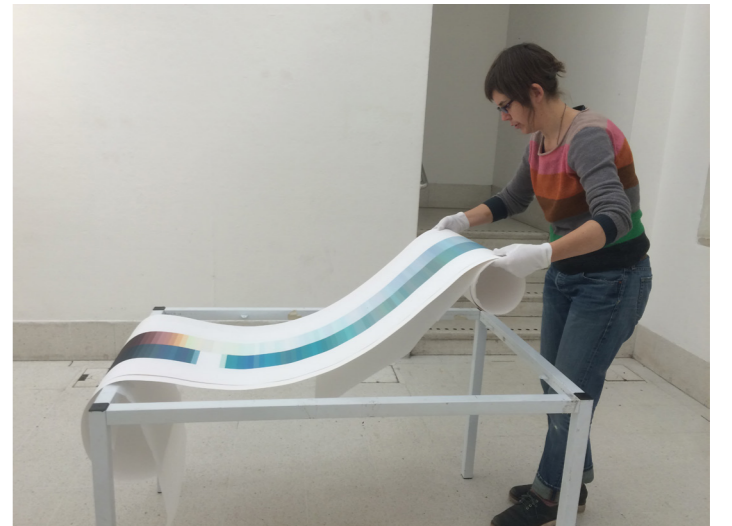
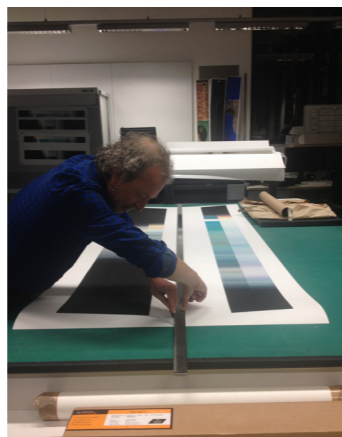
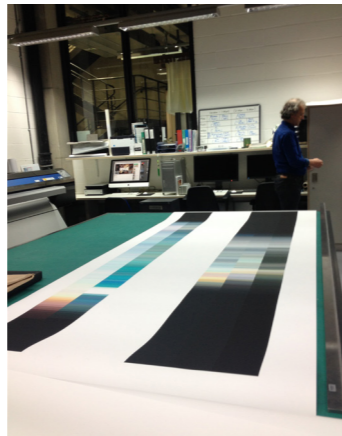
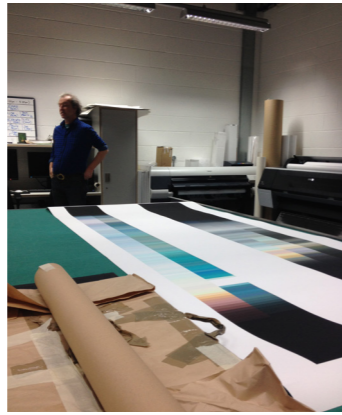





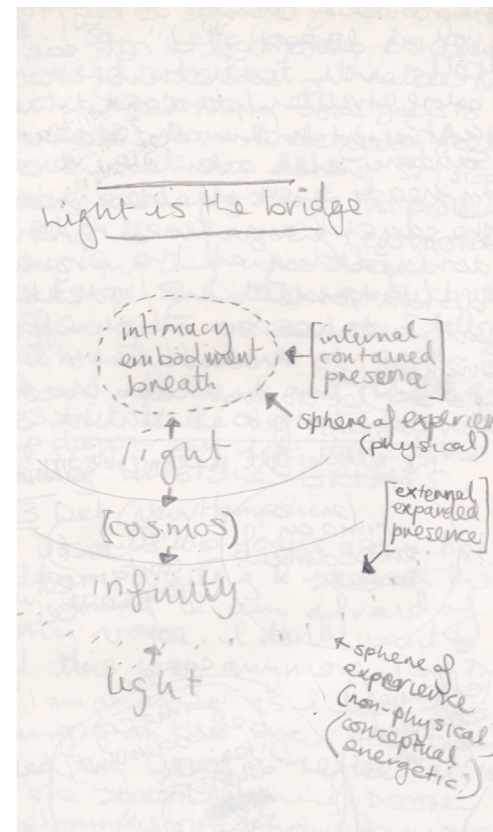
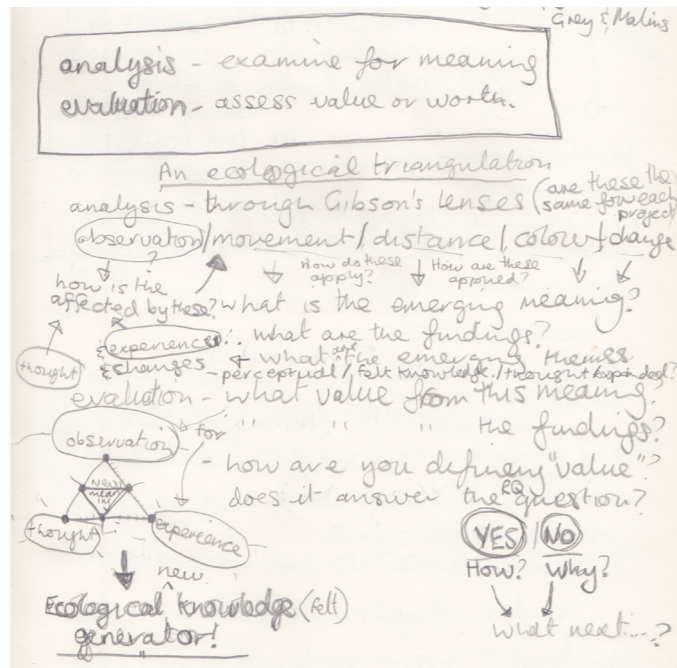

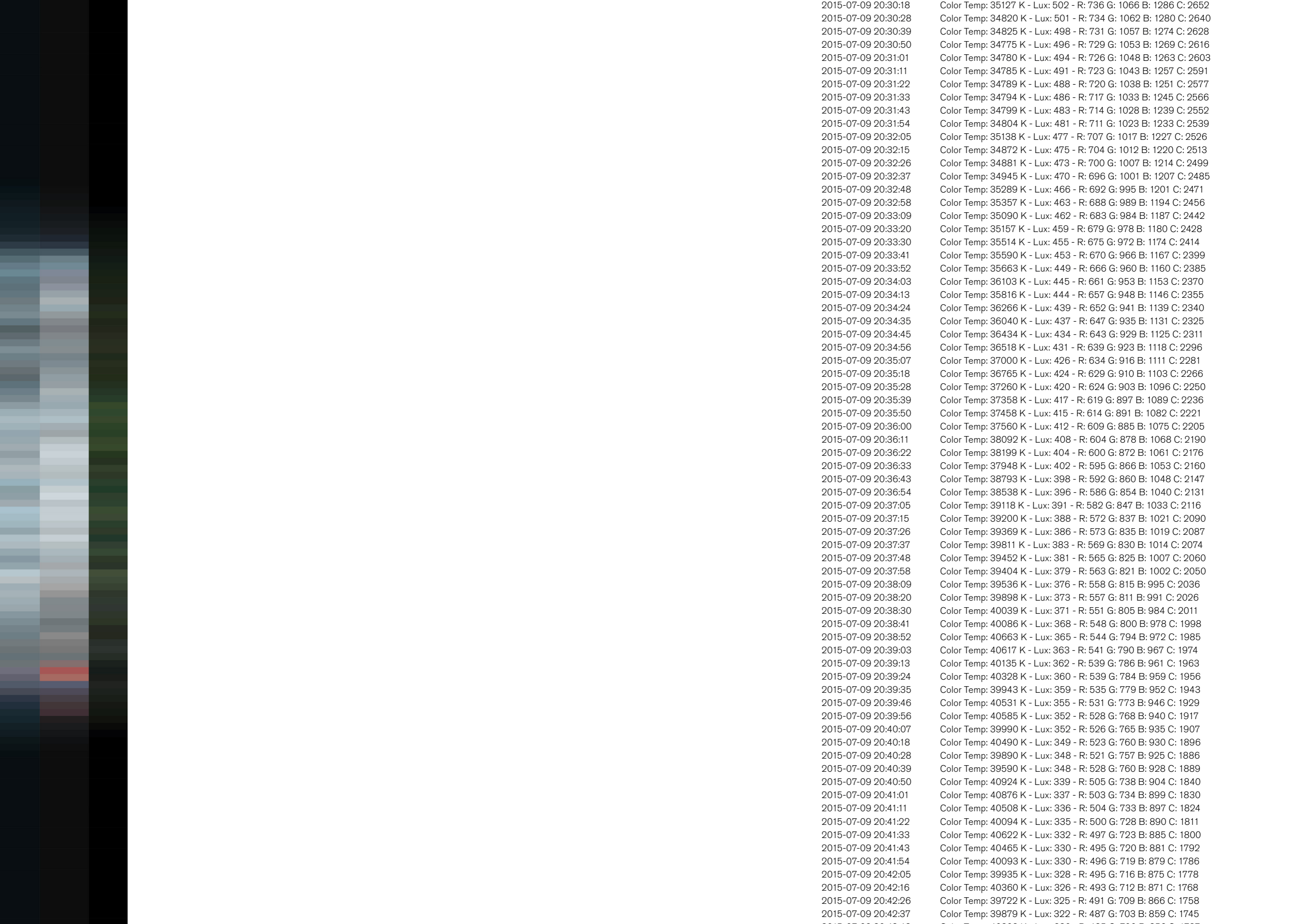

2015-07-09 20:30:18	Color Temp: 35127 K - Lux: 1066 B: 1286 C: 2652
2015-07-09 20:30:28	Color Temp: 34820 K - Lux: 501 - R: 734 G: 1062 B: 1280 C: 2640
2015-07-09 20:30:39	Color Temp: 34825 K - Lux: 498 - R: 731 G: 1057 B: 1274 C: 2628
2015-07-09 20:30:50	Color Temp: 34775 K - Lux: 496 - R: 729 G: 1053 B: 1269 C: 2616
2015-07-09 20:31:01	Color Temp: 34780 K - Lux: 494 - R: 726 G: 1048 B: 1263 C: 2603
2015-07-09 20:31:11	Color Temp: 34785 K - Lux: 491 - R: 723 G: 1043 B: 1257 C: 2591
2015-07-09 20:31:22	Color Temp: 34789 K - Lux: 488 - R: 720 G: 1038 B: 1251 C: 2577
2015-07-09 20:31:33	Color Temp: 34794 K - Lux: 486 - R: 717 G: 1033 B: 1245 C: 2566
2015-07-09 20:31:43	Color Temp: 34799 K - Lux: 483 - R: 714 G: 1028 B: 1239 C: 2552
2015-07-09 20:31:54	Color Temp: 34804 K - Lux: 481 - R: 711 G: 1023 B: 1233 C: 2539
2015-07-09 20:32:05	Color Temp: 35138 K - Lux: 477 - R: 707 G: 1017 B: 1227 C: 2526
2015-07-09 20:32:15	Color Temp: 34872 K - Lux: 475 - R: 704 G: 1012 B: 1220 C: 2513
2015-07-09 20:32:26	Color Temp: 34881 K - Lux: 473 - R: 700 G: 1007 B: 1214 C: 2499
2015-07-09 20:32:37	Color Temp: 34945 K - Lux: 470 - R: 696 G: 1001 B: 1207 C: 2485
2015-07-09 20:32:48	Color Temp: 35289 K - Lux: 466 - R: 692 G: 995 B: 1201 C: 2471
2015-07-09 20:32:58	Color Temp: 35357 K - Lux: 463 - R: 688 G: 989 B: 1194 C: 2456
2015-07-09 20:33:09	Color Temp: 35090 K - Lux: 462 - R: 683 G: 984 B: 1187 C: 2442
2015-07-09 20:33:20	Color Temp: 35157 K - Lux: 459 - R: 679 G: 978 B: 1180 C: 2428
2015-07-09 20:33:30	Color Temp: 35514 K - Lux: 455 - R: 675 G: 972 B: 1174 C: 2414
2015-07-09 20:33:41	Color Temp: 35590 K - Lux: 453 - R: 670 G: 966 B: 1167 C: 2399
2015-07-09 20:33:52	Color Temp: 35663 K - Lux: 449 - R: 666 G: 960 B: 1160 C: 2385
2015-07-09 20:34:03	Color Temp: 36103 K - Lux: 445 - R: 661 G: 953 B: 1153 C: 2370
2015-07-09 20:34:13	Color Temp: 35816 K - Lux: 444 - R: 657 G: 948 B: 1146 C: 2355
2015-07-09 20:34:24	Color Temp: 36266 K - Lux: 439 - R: 652 G: 941 B: 1139 C: 2340
2015-07-09 20:34:35	Color Temp: 36040 K - Lux: 437 - R: 647 G: 935 B: 1131 C: 2325
2015-07-09 20:34:45	Color Temp: 36434 K - Lux: 434 - R: 643 G: 929 B: 1125 C: 2311
2015-07-09 20:34:56	Color Temp: 36518 K - Lux: 431 - R: 639 G: 923 B: 1118 C: 2296
2015-07-09 20:35:07	Color Temp: 37000 K - Lux: 426 - R: 634 G: 916 B: 1111 C: 2281
2015-07-09 20:35:18	Color Temp: 36765 K - Lux: 424 - R: 629 G: 910 B: 1103 C: 2266
2015-07-09 20:35:28	Color Temp: 37260 K - Lux: 420 - R: 624 G: 903 B: 1096 C: 2250
2015-07-09 20:35:39	Color Temp: 37358 K - Lux: 417 - R: 619 G: 897 B: 1089 C: 2236
2015-07-09 20:35:50	Color Temp: 37458 K - Lux: 415 - R: 614 G: 891 B: 1082 C: 2221
2015-07-09 20:36:00	Color Temp: 37560 K - Lux: 412 - R: 609 G: 885 B: 1075 C: 2205
2015-07-09 20:36:11	Color Temp: 38092 K - Lux: 408 - R: 604 G: 878 B: 1068 C: 2190
2015-07-09 20:36:22	Color Temp: 38199 K - Lux: 404 - R: 600 G: 872 B: 1061 C: 2176
2015-07-09 20:36:33	Color Temp: 37948 K - Lux: 402 - R: 595 G: 866 B: 1053 C: 2160
2015-07-09 20:36:43	Color Temp: 38793 K - Lux: 398 - R: 592 G: 860 B: 1048 C: 2147
2015-07-09 20:36:54	Color Temp: 38538 K - Lux: 396 - R: 586 G: 854 B: 1040 C: 2131
2015-07-09 20:37:05	Color Temp: 39118 K - Lux: 391 - R: 582 G: 847 B: 1033 C: 2116
2015-07-09 20:37:15	Color Temp: 39200 K - Lux: 388 - R: 572 G: 837 B: 1021 C: 2090
2015-07-09 20:37:26	Color Temp: 39369 K - Lux: 386 - R: 573 G: 835 B: 1019 C: 2087
2015-07-09 20:37:37	Color Temp: 39811 K - Lux: 383 - R: 569 G: 830 B: 1014 C: 2074
2015-07-09 20:37:48	Color Temp: 39452 K - Lux: 381 - R: 565 G: 825 B: 1007 C: 2060
2015-07-09 20:37:58	Color Temp: 39404 K - Lux: 379 - R: 563 G: 821 B: 1002 C: 2050
2015-07-09 20:38:09	Color Temp: 39536 K - Lux: 376 - R: 558 G: 815 B: 995 C: 2036
2015-07-09 20:38:20	Color Temp: 39898 K - Lux: 373 - R: 557 G: 811 B: 991 C: 2026
2015-07-09 20:38:30	Color Temp: 40039 K - Lux: 371 - R: 551 G: 805 B: 984 C: 2011
2015-07-09 20:38:41	Color Temp: 40086 K - Lux: 368 - R: 548 G: 800 B: 978 C: 1998
2015-07-09 20:38:52	Color Temp: 40663 K - Lux: 365 - R: 544 G: 794 B: 972 C: 1985
2015-07-09 20:39:03	Color Temp: 40617 K - Lux: 363 - R: 541 G: 790 B: 967 C: 1974
2015-07-09 20:39:13	Color Temp: 40135 K - Lux: 362 - R: 539 G: 786 B: 961 C: 1963
2015-07-09 20:39:24	Color Temp: 40328 K - Lux: 360 - R: 539 G: 784 B: 959 C: 1956
2015-07-09 20:39:35	Color Temp: 39943 K - Lux: 359 - R: 535 G: 779 B: 952 C: 1943
2015-07-09 20:39:46	Color Temp: 40531 K - Lux: 355 - R: 531 G: 773 B: 946 C: 1929
2015-07-09 20:39:56	Color Temp: 40585 K - Lux: 352 - R: 528 G: 768 B: 940 C: 1917
2015-07-09 20:40:07	Color Temp: 39990 K - Lux: 352 - R: 526 G: 765 B: 935 C: 1907
2015-07-09 20:40:18	Color Temp: 40490 K - Lux: 349 - R: 523 G: 760 B: 930 C: 1896
2015-07-09 20:40:28	Color Temp: 39890 K - Lux: 348 - R: 521 G: 757 B: 925 C: 1886
2015-07-09 20:40:39	Color Temp: 39590 K - Lux: 348 - R: 528 G: 760 B: 928 C: 1889
2015-07-09 20:40:50	Color Temp: 40924 K - Lux: 339 - R: 505 G: 738 B: 904 C: 1840
2015-07-09 20:41:01	Color Temp: 40876 K - Lux: 337 - R: 503 G: 734 B: 899 C: 1830
2015-07-09 20:41:11	Color Temp: 40508 K - Lux: 336 - R: 504 G: 733 B: 897 C: 1824
2015-07-09 20:41:22	Color Temp: 40094 K - Lux: 335 - R: 500 G: 728 B: 890 C: 1811
2015-07-09 20:41:33	Color Temp: 40622 K - Lux: 332 - R: 497 G: 723 B: 885 C: 1800
2015-07-09 20:41:43	Color Temp: 40465 K - Lux: 330 - R: 495 G: 720 B: 881 C: 1792
2015-07-09 20:41:54	Color Temp: 40093 K - Lux: 330 - R: 496 G: 719 B: 879 C: 1786
2015-07-09 20:42:05	Color Temp: 39935 K - Lux: 328 - R: 495 G: 716 B: 875 C: 1778
2015-07-09 20:42:16	Color Temp: 40360 K - Lux: 326 - R: 493 G: 712 B: 871 C: 1768
2015-07-09 20:42:26	Color Temp: 39722 K - Lux: 325 - R: 491 G: 709 B: 866 C: 1758
2015-07-09 20:42:37	Color Temp: 39879 K - Lux: 322 - R: 487 G: 703 B: 859 C: 1745
2015-07-09 20:42:47	Color Temp: 40322 K - Lux: 322 - R: 487 G: 703 B: 859 C: 1745



