

Glass as Ink:

**Seeking Spontaneity from the
Casting Process**

Sheila Marie Labatt

A thesis submitted in partial fulfilment of the requirements of the Royal
College of Art for the degree of Doctor of Philosophy

2018

Copyright Statement

This text represents the submission for the degree of Doctor of Philosophy at the Royal College of Art. This copy has been supplied for the purpose of research for private study, on the understanding that it is copyright material, and that no quotation from the thesis may be published without proper acknowledgment.

Abstract

Glass as Ink: Seeking Spontaneity from the Casting Process

This practice-based research addresses internal form in cast glass. That is, ink-like imagery, which is wholly contained within clear, colourless glass. For the purposes of this project, 'ink' refers to liquid ink as is used in Chinese brush painting and calligraphy rather than to ink applications such as those used in print media. The aim is not to use ink itself. Rather, it is to emulate ink, rendered inside glass, while exploring the material similarities between the two media, including their liquid properties and their ability to be worked opaque or translucent.

The project examines the interface between control and chance; where the artistic process ends and the unique properties of glass take over and are governed by heat, time and gravity. It also addresses the transformation of two-dimensional line drawing and ink wash into the third dimension.

My research question is how the kiln and furnace casting processes can best be exploited to render the fluid, gestural and expressionistic immediacy of brush and ink painting, three-dimensionally, in solid glass.

Following 14 years of studying and making art in Korea (1997–2003) and China (2003–2010), I have developed an affinity for brush and ink painting and, more specifically, for Chinese Grass script calligraphy and traditional landscape. This project aims to explore various methods of capturing apparent gesture and spontaneity in cast glass, in the form of 'ink' abstractions that evoke these styles of Chinese painting.

My methodology includes identifying and isolating the elements that characterise Chinese brushwork in calligraphy and landscape painting, which are intimately linked fine art forms in China. Studio tests include manipulating different types of glass to create a dynamic, rhythmic, assured and graceful ink aesthetic, interpreted in the third dimension. I use frameworked inclusions to explore ink-like line and experiment with glass powders to evoke different intensities of ink wash. All tests are recorded in detail and are used to anticipate and loosely control glass movement. My research into Chinese brushwork characteristics is used to identify a framework within which the studio work sits.

The variety, order and combination of techniques used to create the work constitute original knowledge in the field of cast glass. My method for reinterpreting the characteristics of Chinese painting, including line quality, ink wash, composition and balance, embedded three-dimensionally within the framework of cast glass, also contributes new knowledge. Based on systematic research and analysis, the terms 'casting', 'moulds', 'spontaneity' and the 'third dimension' are examined and defined anew.

摘要

玻璃如墨：探寻铸造过程中的自发性

这是一个关于铸造玻璃内部形式的实践性研究项目，即在透明、无色的玻璃内部表达类似墨的图案。为了本项目研究的目的，“墨”指代中国传统水墨绘画和书法中的液体墨汁，而非印刷技术中的介质。其主旨并不是使用墨本身，而是为了在玻璃内部模仿墨的效果，以揭示两种材料的相似性，比如：他们的液体特质，以及可呈现的透明和不透明性。

该项目试图探索控制力和偶然性之间的界限；当艺术家完成创作过程之后，转而发挥由热量、时间和重力所支配的玻璃材料的独特性质。另外，该研究还试图解决线条绘画和水墨二维形式到三维形式的转换。

本课题研究的主要问题是：窑制和热玻璃铸造过程中如何最佳的在固体玻璃中三维立体地渲染水墨绘画的流动、表达和表现主义即时性。

自从在韩国（1997-2003年）和中国（2003-2010年）从事艺术创作以来，我由衷地喜欢水墨画，尤其是中国的草书书法和传统山水画。本课题旨在探索铸造玻璃工艺所呈现的多样表现性和自发性，以抽象“墨”的形式唤起中国绘画风格的表达。

研究的方法论包括对于中国美术形式中有着密切关联的书法和山水画笔墨特征的辨析，而工作室的实验主要是在不同种类的玻璃中三维立体地表达具有生动、节奏、自信、优雅的水墨美学的实践研究。同时我还使用灯工工艺预先制作类似水墨线条的玻璃部件，或使用玻璃粉末等形式，探索不同浓度水墨效果的表达。所有的测试都被详细的记录在案，用于预测和在一定程度上控制玻璃的运动。对于中国笔触特征的研究同样也是为了确定工作室创作的框架内容。

作品创作过程中工艺技术的多样性、有序性和组合性构建了铸造玻璃领域中的原创性知识，重新解读中国传统绘画的方法，比如：勾线的质量、水墨效果、构图、平衡等，也都一一植入铸造玻璃三维立体的形式中，同样构建了新的知识内容。基于系统的研究和分析，研究课题对“铸造”、“模具”、“自发性”和“三维”这些术语进行了重新审视和界定。

Acknowledgements

This thesis is dedicated to my children, Fraser and Jessica, whose quiet confidence, optimism and tenacity, in all that they do, will inspire me always.

I am indebted to my supervisors, Alison Britton and Dr. Heike Brachlow, for sharing with me their vast and complementary knowledge and for their confidence and encouragement throughout. Thanks also to Annie Cattrell and Martin Smith for their insights and to the staff at the Rakow Research Library for their generous help.

I could not have completed this thesis without help and advice from my many friends and colleagues in China; in particular, Dr. Xue (Shelly) Lü for her guidance over the course of this project and for translating my abstract. Enormous thanks also to Wang Qin who has supported me and shared his deep knowledge of Chinese art and philosophy for many years. Thanks also to Professor Zhuang Xiaowei, whose belief in me ultimately led to this research project, and to Professor Xiao Tai, Sunny Wang and Luo Xiaosu, for their ongoing support.

I would also like to thank Gerry Blunt and Cathy Johns for their careful editing, Matilda Thaddeus-Johns for her patient formatting guidance and Yao Wang for her emergency IT assistance. Thanks also to Liam Reeves, Stefan Stefanou and Anthony Harris for their technical expertise and support.

Finally, I thank my parents, Sonia and Arthur Labatt, as well as Dominic Barton, Felicity Aylieff, Charlotte Humphrey and my fellow research students for helping me navigate the speed bumps.

Thank you.

Author's Declaration

During the period of registered study in which this thesis was prepared, the author has not been registered for any other academic award or qualification.

The material included in this thesis has not been submitted wholly or in part for any academic award or qualification other than that for which it is now submitted.

TABLE OF CONTENTS

Copyright Statement	ii
Abstract	iii
摘要	iv
Acknowledgements	v
Author's Declaration	vi
TABLE OF CONTENTS	1
TABLE OF FIGURES	5
LIST OF PLATES	18
I INTRODUCTION	19
1. Impetus for the Project.....	19
2. Aims and Scope.....	21
3. Thesis.....	22
II CASTING, SPONTANEITY AND FLOW	26
1. Introduction.....	26
2. Casting Definition and Context.....	26
a) Introduction.....	26
b) Casting Definition.....	28
(i) The Cast Object: Relative Weight and Density.....	28
(ii) The Casting Process: Relative Temperature.....	30
c) What is a Mould?.....	32
d) Temporal Placement of Casting.....	34
3. Spontaneity and Flow: Elusive Immediacy in Cast Glass.....	35
a) Spontaneity and Flow: A Working Definition.....	35
b) Spontaneity of Effect, shibusu (渋さ) and wúwéi (无为).....	37
4. Summary.....	39
III INK	41
1. Introduction.....	41
2. Reinterpreting Traditional Chinese Painting.....	42
3. The Four Treasures of the Study.....	47

a)	Brush	47
b)	Paper	49
c)	Ink Stick and Ink Stone	50
4.	Line	51
a)	Gesture in Brush and Ink Painting.....	51
b)	Chinese Calligraphy	52
(i)	Introduction.....	52
(ii)	Standard Script (楷书 kǎishū)	55
(iii)	Grass Script (草书 cǎoshū)	57
5.	Wash.....	60
a)	Introduction	60
b)	Wash Qualities	62
c)	Landscape	64
6.	Colour and Chops.....	71
7.	Ink and the Third Dimension.....	79
a)	The Third Dimension Problem in Art.....	79
b)	Calligraphy and Landscape Motifs	82
(i)	Two-dimensional Rendering.....	83
(ii)	Three-dimensional Rendering.....	87
8.	Summary	90
IV	GLASS.....	91
1.	Introduction.....	91
2.	Ancient Chinese Glass: Materiality and Appreciation	92
3.	Qing Dynasty Glass (1644–1912).....	96
4.	Contemporary Context	100
a)	Introduction	100
b)	The Chinese Studio Glass Movement.....	101
5.	Artist Survey: Technical and Aesthetic Context.....	113
a)	Introduction	113
b)	Technical Context: Voids, Bubbles and Displacement.....	114
c)	Aesthetic Context: Casting – Ink, Landscape and Calligraphy	118
d)	Aesthetic Context: Non-casting Techniques – Ink and Calligraphy.....	128
e)	Discussion	131
(i)	Bubbles, Voids and Movement.....	132
(ii)	Cross-cultural Inspiration.....	133

(iii) Spontaneity and shibusa (渋さ).....	134
(iv) White and the 'Leaving Blank' Principle.....	136
(v) Language and Communication.....	137
(vi) Dimensionality.....	139
6. Summary.....	142
V TECHNIQUES EXPLORED IN THIS PROJECT.....	144
1. Introduction.....	144
2. Choice of Glass.....	144
3. Introducing Colour into the Glass.....	149
a) Trapping Colour between Glass Slabs.....	149
b) Fusing Colour onto Sheet Glass.....	150
c) Hot Casting with Colour Inclusions.....	151
4. Manipulating Inclusions Three-Dimensionally.....	154
a) Introduction.....	154
b) Flow into a Void.....	155
c) Bubbles in Hot Casting.....	161
d) Bubbles in Kiln Casting.....	163
5. Summary.....	170
VI RESULTS.....	172
1. Introduction.....	172
2. Evaluation.....	173
a) Grass Script II.....	173
b) Ink Pot II.....	178
c) Wash IV.....	180
d) Fan.....	183
e) Fan II.....	187
f) Flying White.....	190
g) Out of the Box III.....	194
h) Parallax.....	196
i) Bonzai.....	201
j) Krakatoa.....	205
VII CONCLUSION.....	210
1. Thesis.....	210
2. Contributions to Knowledge.....	215

a) Introduction	215
b) Aesthetic.....	216
c) Technical.....	216
d) Linguistic.....	216
3. Further Investigation	217
APPENDIX I DATES, ROMANISATION AND NAMES	220
APPENDIX II AMORPHOUS SOLIDS AND TEMPERATURE	223
APPENDIX III PATE DE VERRE AS FUSING.....	224
APPENDIX IV CV.....	227
APPENDIX V TESTS AND RESULTS.....	232
APPENDIX VI PLATES	350
APPENDIX VII GLOSSARY	362
BIBLIOGRAPHY.....	369

TABLE OF FIGURES

Figure 1 <i>Huangshan</i> , 2005-2006, Sheila Labatt, cast glass, milky veiling in upper third resembles the top of Mount Huangshan, 23x6x6cm. Photo: Xiao Jin.....	20
Figure 2 <i>Huangshan (Yellow Mountains)</i> , 2007. Photo: ©Aaron D. Feen.....	20
Figure 3 <i>Memories of Mt. Huangshan</i> , 1961, Zhang Daqian, ink and colour on paper, 137x69 cm hanging scroll. Source: sothebys.com/en/auctions/ecatalogue/lot.1226 © 2018 Sotheby's	20
Figure 4 <i>Evening Dress with Shawl</i> , 2004, Karen LaMonte, cast glass, hollow and lightweight relative to its size. 150x121x60cm. Collection: Corning Museum of Glass (2005.3.21)	28
Figure 5 <i>Stella</i> candle holder, 1960s, Sven Palmquist for Orrefors, blown crystal. The centre hole is the diameter of a pencil, making the piece dense in relation to its size. Ø6.5x6cm.	28
Figure 6 <i>Horizontal Outcast</i> , 2011, John Sharvin, hot-sculpted glass, dense in relation to its size, 55x22x30cm. Source: jessieblackmer.com/student-portfolio	29
Figure 7 <i>Quiver</i> , 1998, Daniel Clayman, cast glass and bronze, mass and volume are not defining criteria, 23x53x24cm. Source: danielclayman.com/protection	29
Figure 8 Achaemenid Persian Phiale (shallow bowl), c. 450–330 BCE, cast glass, hollow and thin-walled, Ø17.5x 3.2cm. Collection: Corning Museum of Glass (59.1.578).....	30
Figure 9 <i>Pacific Bowl</i> , 1991, Ann Robinson, cast crystal glass, thin walls in relation to weight, Ø64.5x30.5cm. Museum of New Zealand Te Papa Tongarewa, Wellington (1996-0033-32)....	30
Figure 10 Title unknown, 2012, Ian Whittaker, float glass slumped at working temperature (without flowing) into a sand mould, dimensions unknown. Source: ianwhittaker.com/glass-slumping	32
Figure 11 Lorin Silverman using jacks and paddle as a 'mould' to contain the glass (2013). Video still: Sheila Labatt.....	33
Figure 12 <i>Abstract Landscape</i> , 1962, Lui Shou Kwan, father of the New Ink Movement, brush and ink on paper, challenging traditional landscape painting aesthetics, 45x46cm. Source: alisan.com.hk/en/artists.....	42
Figure 13 <i>Beautiful Dream 4</i> , 2008, Duan Jianyu, ink on cardboard, challenging traditional landscape painting in new media, 51x60cm. Collection: M+ Museum of Visual Culture, Hong Kong, © Duan Jianyu	43
Figure 14 <i>Family Tree (Detail)</i> , 2000, Zhang Huan, performance and photography, calligraphy reinterpreted in non-traditional body painting. Source: zhanghuan.com.....	43
Figure 15 <i>Book from the Sky</i> , 1987–1991, Xu Bing, mixed media installation/hand-printed books and scrolls, printed from blocks inscribed with faux Chinese characters. Installation at Taipei Fine Arts Museum, 2014. ©Xu Bing Studio.	44
Figure 16 <i>Viewing the City's Places of Interest in Springtime</i> , 2007, Yao Lu 姚璐, Chromogenic print, landscape reinterpretation in new media, 80x80cm. Source: uk.phaidon.com.....	45
Figure 17 <i>CCTV 'Ink' Making-of</i> , 2009-2010, WeareFLINK, video (still, 5:13), research into ink movement in water. Source: vimeo.com/20410575.....	45

Figure 18 <i>Ink (Directors Cut)</i> , 2010, WeareFLINK, award-winning landscape animation video (still, 0:09), for CCTV, Beijing. Source: vimeo.com/20409478	46
Figure 19 He Wenjun (2009) painting calligraphy with his (then) largest brush ever made. Source http://metro.co.uk/2009/09/23/brush-with-greatness-the-world-record-breaking-paintbrush-439954/	47
Figure 20 <i>One Stroke Snake Painting for 2013</i> , 2013, (video still, 2:17), using a single Chinese brush to demonstrate a range of wash and line in one stroke. Source: https://www.youtube.com/watch?v=dKJkBFEWc3g	48
Figure 21 Organic straight lines using Chinese brush and ink (left), straight, even lines using broad-topped metal pen and ink (top right) and reed-nib and ink (bottom right)	48
Figure 22 Tung oil soot ink stick and lidded ink stone, used for grinding liquid ink. Source: Blue Heron Arts.....	50
Figure 23 <i>The Line</i> (detail), 1954, Saul Steinberg, ink on paper, drawing without gesture. Collection: The Saul Steinberg Foundation.....	52
Figure 24 Untitled, 1948, Saul Steinberg, ink on paper, focused yet gestural drawing style, emanating from the shoulder, 36x29cm. Collection: Saul Steinberg Papers, Beinecke Rare Book and Manuscript Library.....	52
Figure 25 Untitled, 2005, Cy Twombly, acrylic on canvas, liberating semantics in gestural painting, 318x469cm. © Cy Twombly Foundation	54
Figure 26 <i>Sumi II</i> , 1957, Mark Tobey, Chinese calligraphy-inspired, ink on paper, 33x 24cm. Source seattleartresource.com/mystic-modernism	54
Figure 27 The character for 'eternity', 永 (yǒng), in six calligraphic styles, showing progressive abstraction from Standard script (left) to Grass script (right).....	55
Figure 28 The eight basic strokes of Standard script and the character 永 (yǒng/eternity), showing gently-tapering lines and 'silkworm heads' and 'goose tail ends' in the héng stroke (upper left)	56
Figure 29 Pen and ink Gothic (or Blackletter) calligraphy style, showing straight, even lines and sharp angles	56
Figure 30 Practice paper showing square grids, with six properly-balanced Standard script characters to copy. © 2001-2013 Good Characters, Inc.....	57
Figure 31 Autobiography (detail), 777AD, Huai Su, ink on paper, 28x755cm handscroll, his brush was 'as swift as a galloping stallion'. Collection: National Palace Museum, Taipei (故書-000062-00000)	58
Figure 32 縛 (fù, to bind), character from Mao Zedong's poem 'Mount Liupan' (1935), in his own wild cursive Grass script calligraphy (1961). Source: Chinese Calligraphy, Ouyang Zhongshi et al.	58
Figure 33 Extreme abstraction of cursive Latin script, representing the extent to which Grass script is abstracted from Standard script. Illustration: Sheila Labatt	59
Figure 34 Chrysanthemum (菊花 júhuā) in Standard script, two characters in 20 strokes	59

- Figure 35 *Poem by Cui Shu* (detail), Ming Dynasty, early to mid-16th century, Wen Peng, ink on paper, chrysanthemum (菊花 júhuā) in Grass script, two characters in a single stroke also demonstrating the 'flying white' technique, 84x42cm hanging scroll. Collection: Freer Gallery of Art, (F1980.10).....59
- Figure 36 *Morpheus*, 1988, Helen Frankenthaler, diluted acrylic on unprimed canvas, showing flat, luminous, merging washes. 295x229cm. Source: Miles McEnery Gallery, 201460
- Figure 37 *Xiao and Xiang Rivers*, Five Dynasties (907–960AD), Dong Yuan, ink and colour on silk, early example of literati ink wash painting, shunning traditional concepts of beauty in landscape painting in favour of spiritual expression, 50x141cm handscroll. Collection: Palace Museum, Beijing62
- Figure 38 The Five Colours of Black in dry and wet brush techniques. Source: <https://sns.91ddcc.com/t/44307>62
- Figure 39 *Sitting in the Rain on Mount Qingcheng*, 1933, Huang Binhong, ink and colour on paper, demonstrating the Five Colours of Black, 87x44cm hanging scroll. Collection: Zhejiang Provincial Museum, Hangzhou.....63
- Figure 40 *Black series*, c.1963, Ad Reinhardt, oil on canvas, works inspired by Chinese landscape painting. Photo credit: John Loengard; The LIFE Picture Collection64
- Figure 41 *The Kangxi Emperor's Southern Inspection Tour, Scroll Three: Ji'nan to Mount Tai*, c.1698, Wang Hui, ink and colour on silk, traditional Chinese landscape, alive with expression, movement and qi, 68x1394cm handscroll. Collection: Metropolitan Museum of Art, New York (1979.5a-d).....65
- Figure 42 *Mountain Landscape with River and Travelers*, 1553, Pieter Bruegel the Elder, pen and brown ink landscape drawing demonstrating energy and flow, and evoking qi, 23x 34cm. Collection: The British Museum, London (183006001).....66
- Figure 43 *Early Spring*, 1072, Guo Xi, ink and light colour on silk, floating perspective or the 'angle of totality', 158x108cm. Collection: National Palace Museum, Taipei (故-畫-000053-00000)67
- Figure 44 *Landscape with Bridge*, 1909, Pablo Picasso, oil on canvas, cubist landscape painted from multiple vantage points, 81x100cm. Collection: Narodni Galerie, Prague.....68
- Figure 45 *Yellow Islands*, 1952, Jackson Pollock, oil on canvas, non-representational abstract expressionist landscape, 144x185cm. Collection: Tate, London (T00436).....70
- Figure 46 After Wang Wei's *Clearing of Rivers and Mountains after Snow*, 1668, Wang Shimin, ink on paper, vertical format landscape, abstract-expressionistic yet recognisable as a landscape, 134x60cm hanging scroll. Collection: National Palace Museum, Taipei.....70
- Figure 47 *White Clouds at the Xiao and Xiang Rivers*, 1627, Dong Qichang, ink on paper, leaving blank space. 'Form does not differ from emptiness, emptiness does not differ from form.' 29x341cm handscroll. Collection: Liaoning Provincial Museum, Shenyang71
- Figure 48 *Phantom Landscape II, No. 1*, 2006, Yang Yongliang, ink jet print, black and white literati-style landscape using digitally-manipulated photographs of factories, construction cranes, power lines and densely-stacked skyscrapers, 60x132cm. ©Yang Yongliang:74

- Figure 49 *Emperor Minghuang's Journey to Shu*, Song Dynasty (960–1279), attributed to Li Zhaodao, ink on silk, showing 'grue' and other muted colours, 56x81cm hanging scroll. Collection: National Palace Museum, Taipei (中-畫-000003-00000)75
- Figure 50 *Splashed-Color Landscape*, 1965, Zhang Daqian, ink and colour on paper, showing vibrant, mineral colours, used on blank area on front surface of a contemporary Chinese landscape, 60x96cm. Collection: The Metropolitan Museum of Art, New York (1986.267.361)75
- Figure 51 Vermilion imprint of the Qianlong Emperor's white jade seal, carved c.1793, bearing the inscription 自强不息 (zìqiáng bùxī, strive continuously to become stronger), 4x4cm. Source: sothebys.com/en/auctions/ecatalogue/2017/important-chinese-art-hk0745/lot.362376
- Figure 52 *In Memory of Confucius in Dream* (仲尼梦奠帖), date unknown (627–641), Ouyang Xun, regarded as the best example of Standard script calligraphy in China, bearing many scholars' and collectors' chops, demonstrating widespread appreciation of the work, 34x26cm. Collection: Liaoning Provincial Museum, Shenyang77
- Figure 53 *Ink Fall*, 2009, Denis Brown, giclée print on watercolour paper, Western contemporary calligrapher uses red Chinese chops in conjunction with his signature, 48x33cm. Source: quillskill.com/prints/inkfall78
- Figure 54 *Soaring*, 2010, Chen Jinhu 陈金虎, ink on paper, chops as subject matter rather than signature, 52x73cm. Source: Shanghai Ding Jie Gallery Catalogue78
- Figure 55 *LOVE*, 1966–1999, Robert Indiana, polychrome aluminum, the sculpture is an extrusion of two-dimensional imagery and is therefore two-dimensional, 366x366x183cm. Location: New York City. Photo: Hu Totya (2006)80
- Figure 56 How do we know whether the figure is three-dimensional? Source: imaginingthetenthdimension.blogspot.co.uk/2012/01/poll-86-impossible-to-see-3rd-dimension 80
- Figure 57 永 (yǒng), 2012, Sheila Labatt, three-quarter view, hotworked glass, refraction and depth create apparently three-dimensional, calligraphic inclusion, 10x10x10cm. Photo: Sheila Labatt82
- Figure 58 永 (yǒng), 2012, Sheila Labatt, top view, encased image reads as segments of unidimensional lines and is therefore two-dimensional. Photo: Sheila Labatt82
- Figure 59 Carved stele (detail), Yan style Chinese calligraphy, Stele Forest museum, Xian, China. Photo: Tony Y.J. Chou (2008)83
- Figure 60 *Mosquito Nails Painting* (part of a series), c.2010, Chen Chun-Hao. 'Mosquito nail' reinterpretation of a Song Dynasty landscape painting (left). Detail (right). Source: ignant.com/2012/06/25/nail-art/ © Chen Chun-Hao83
- Figure 61 *Writing IX Temple Jar*, 2013, Jared FitzGerald, porcelain, abstract calligraphic lines on surface of three-dimensional object that can notionally be rolled out into a two-dimensional plane, 54x51cm. Source: fitzgeraldfinearts.com/exhibitions/haughton-international-fair-2014/selected-works?view=slider#2384
- Figure 62 The character 永 (yǒng) painted on eggshell piece, using black glass powder and acrylic medium. Photo: Sheila Labatt84

- Figure 63 Allusion to chops, painted on eggshell piece using vermilion glass powder and acrylic medium. Photo: Sheila Labatt.....84
- Figure 64 *Drinking Tea*, 2001-2003, Xue Lei, hand-painted porcelain, complex shapes in contemporary ceramic objects (cans), painted in traditional Jingdezhen blue. Source: Galerie Hubert Winter.....85
- Figure 65 Untitled, c.2009, Dustin Yellin, two-dimensional, encased 'ink' imagery, dimensions unknown. Source: Samuel Freeman Gallery, Eden Disorder Exhibition, March 201085
- Figure 66 *Fossil*, 2004, Lu Bin, unglazed porcelain, bas relief carved characters evoke ancient oracle bones. 9x38x14cm. Collection: Sheila Labatt. Photo: Sheila Labatt86
- Figure 67 Mountain-shaped censer, Western Han Dynasty (206 BC–AD 9), red earthenware with green glaze, Ø18x23cm. Collection: Lucy Maud Buckingham (1924.239)87
- Figure 68 Mountain-shaped censer, from the tomb of Liu Shen (d. 113 BCE), Western Han Dynasty, bronze with gold inlay, three-dimensional landscape, Ø12x26cm. Collection: Hebei Provincial Museum, Shijiazhuang87
- Figure 69 *Under the Wave off Kanagawa*, c. 1830–32, Katsushika Hokusai, polychrome woodblock print, ink and colour on paper, 26x38cm. Collection: The Metropolitan Museum of Art, New York (JP1847).....88
- Figure 70 *The Wave* 浪, 2005, Ai Weiwei, celadon-glazed ceramic, three-dimensional representation of stylised waves, 16x43x38cm. Source: metmuseum.org/exhibitions/. © Ai Weiwei.....88
- Figure 71 《饮水思源》 *Flowing*, 2014, Chua Boon Kee, forged stainless steel, large-scale, three-dimensional Grass script calligraphy. Location: 124 Shaftsbury Avenue, London.....88
- Figure 72 Starling Murmuration in Gretna Green, 2013, 'ink wash' come to life. Photo credit: Owen Humphreys89
- Figure 73 Press-moulded, translucent glass bi, imitating jade, ritual burial disc, Han Dynasty (206 BC–220AD), Ø16x0.5cm. Collection: Corning: Museum of Glass (51.6.548).....95
- Figure 74 Vase, imitating ceramics in mould-blown, opaque glass, from the period of Qing Emperor Yongzheng (r.1723–c.1735). Yellow wares were strictly reserved for the Emperor. Ø11x11cm. Collection: British Museum, London (1873.1215.1) ©2017 Trustees of the British Museum.....97
- Figure 75 Pair of cameo cut, covered jars, Qing Dynasty, 18th Century, displaying advanced lapidary skills and rare traditional Chinese landscape motifs, Ø13x14cm. Collection: Suntory Museum of Art, Tokyo98
- Figure 76 *1889 Exhibition* vase, 1889, Thomas Webb & Sons, cameo cut glass in Chinoiserie style, H: 49.5cm. Source: <https://www.christies.com/lotfinder/Lot/a-thomas-webb-sons-cameo-glass-5845750-details.aspx>.....98
- Figure 77 Snuff bottle, Qing Dynasty, Yu Shuyun, inside-painted landscape with Grass script calligraphy and red chop, height 6cm. Source: sothebys.com/en/auctions/ecatalogue/2013/bloch-vii-hk0495/lot.70 (2013) ©2018 Sotheby's 99

- Figure 78 *The Flower of Meditation Speaks the Truth of Dharma*, 2000, Loretta Hui-shan Yang, traditional Chinese references in transparent hot and kiln cast glass, with Liuli Gongfang chop in frame, 72x19x16cm. Source: liuli.com.cn/news/20th_dharma_speaks_sc.....102
- Figure 79 *Bowl*, 2007, František Vízner, cast and cut glass, Ø32cm. Source: frantisekvizner.com © 2010 František Vízner Collection104
- Figure 80 *Grey Flute Series: Sea Blue*, 2006, Zhuang Xiaowei, cast glass, inspired by minimalist, cast Czech glass, 63x18x17cm. Collection: National Museum of Scotland (V.2008.2)104
- Figure 81 *Dignity of Han Official*, 2008, Luo Xiaosu, Chinese historical reference rendered in Western, cubist aesthetic, 80x27x12cm. Photo: courtesy of the artist.....105
- Figure 82 *A Study on the Space of Buddhist Statues*, 2016, Luo Xiaosu, inspired by the Buddhist caves at Dunhuang, dimensions unknown. Photo: courtesy of the artist105
- Figure 83 *City Gate Series VII*, 2006, Guan Donghai, opaque and translucent cast glass, glass inspired by London's preservation of old buildings and ancient Chinese architecture, 47x32x13cm. Source: liuliart.cn/Photo/HTML/Photo_584106
- Figure 84 *Fruit of the Sea VII*, 2007, David Reekie, opaque and translucent cast glass, pâte de verre, enamel, the 'intrinsic beauty of glass holds little fascination' for him, 41x16x14cm. Source: caa.org.uk/exhibitions/archive/2008/myths-and-legends/david-reekie/107
- Figure 85 'Young Chinese Glass Family', 2006, early Shanghai University glass studio-members on Sheila Labatt's rooftop in Xintiandi, Shanghai. Photo: Fraser Barton.....110
- Figure 86 Preparation of Long Horn Miao headdress, consisting of a horn-shaped armature, ancestors' hair and yarn. Photo: Roberto Stocco111
- Figure 87 *Miao Mix*, 2006, Sheila Labatt, cast crystal with steel nails, Award of Excellence, Nanjing, 2007, 50x90x15 cm. Photo: Xiao Jin.....111
- Figure 88 *The Long History of Chinese Ink Painting*, 2012, Sheila Labatt, cast crystal, 71x26x9 cm. Photo: Xiao Jin112
- Figure 89 *New Shanghai II*, 2007, Sheila Labatt, cast crystal, referencing Shanghai's unrelenting construction of skyscrapers, red chop reference in lower left corner, Academy Award (Best in Show), Shanghai, 2008, 38x10x10cm. Photo: Xiao Jin.....112
- Figure 90 *Asahi Lumina with Bronze and Mirrorized Disk*, 1991–1993, Tom Patti, glass, highly-controlled and symmetrical bubble placement, centred inside a near-cube, symbol of stability and permanence, 9x16x12. Corning Museum of Glass (2007.4.187) Gift of the Ben W. Heineman Sr. Family114
- Figure 91 *Double C Boat*, from 1999–2003 series, Steven Weinberg, cast crystal, using precise bubble placement to delicately drag colour from the bottom, 17x36x9cm. Source: echtgallery.com/steven-weinberg/115
- Figure 92 *Flower Block*, 2012, Steffen Dam, blown, cast and fused glass, static bubbles contrast with veiling displaced by bubble in lower left corner, 28x58cm. Collection: Corning Museum of Glass, 27th Rakow Commission (2012.3.36).....116
- Figure 93 *L'instant juste avant III*, 2002, Antoine Leperlier, cast glass, geometry bordering on organicity, 18x18x19cm. Source: antoine-leperlier.com, œuvres 2002.....117

- Figure 94 Untitled, 1984, Willi Pistor, optical glass, bubble movement produces organic and asymmetrical veiling, 13x21x13cm. Source: liveauctioneers.com/item/5373710_782-objekt-willi-pistor-glass-object-contemporary118
- Figure 95 凝霜7 (*Snow 7*), 2007, Xue (Shelly) Lü, pâte de verre, spontaneous-looking, abstract 'ink' marks, inspired by denuded trees, Ø16cm. Source: Two Cities Gallery, Shanghai, Foundation Spring Show exhibition catalogue119
- Figure 96 *Ink 15*, 2005, Xue (Shelly) Lü, centrifugally cast glass, fluid and spontaneous ink-like marks, Ø26. Photo: courtesy of the artist119
- Figure 97 *Poetics of the Handmade II*, 2011, Zhuang Xiaowei, cast glass, spontaneous 'ink' application, 90x19x15cm. Source: litvak.com/external-gallery/750120
- Figure 98 *Ink in Water Drapery Study*, 2008, Karen LaMonte, bas relief cast glass, evokes liquid ink, 60x92x7cm. Source: karenlamonte.com121
- Figure 99 *The Plate Series 2*, 盘器系列, 2008, Xiao Tai, cast glass, oblique reference to ink painting, Ø32x5cm. Photo courtesy of the artist121
- Figure 100 *Landscape Series 1* 山水之, 2013, Xiao Tai, fused and slumped glass, abstract traditional Chinese landscape with traditional colours, 25x18x2cm. Source: taiglass.org, Landscape Series121
- Figure 101 *Non-Calligraphy XVI*, 2008, Wang Qin, cast glass, evokes contemporary brush and ink calligraphy, 91x52x6.5cm. Source: wangqinstudio.com, Non-Calligraphy Series122
- Figure 102 *Happy Mover*, 2008, Yang Xiaojian, ink on paper, contemporary brush and ink calligraphy, 150x90cm. Collection: Sheila Labatt122
- Figure 103 *Zen Mountain II*, 2010, Wang Qin, cast glass and antique wooden frame, evokes contemporary ink landscape painting in a traditional frame, 33x58x18cm. Source: wangqinstudio.com, Zen Mountain Series123
- Figure 104 *Late Spring*, 2008, Wang Qin, cast glass, abstracted, traditional Chinese landscape demonstrating classical methods for representing depth of field, 91x52x6.5cm. Source: wangqinstudio.com, Distant Mountains Series123
- Figure 105 *Zen Mountain IV*, 2011, Wang Qin, cast glass, scale of iconic Chinese karst mountains evokes the sublime vastness of nature, three-dimensionally, 45x32x6cm each. Source: wangqinstudio.com, Zen Mountain Series124
- Figure 106 Yangshuo's karst mountains as depicted on the ¥20 note and reproduced in miniature in *Zen Mountain IV*124
- Figure 107 *Zen Mountain III*, 2010, Wang Qin, cast crystal, high-ratio dimensions of 99.5x11x3cm evoke the sublimity of nature and the universe and the scale and format of Chinese landscape scrolls. Source: wangqinstudio.com, Zen Mountain Series125
- Figure 108 *Flux et Fixe XXVIII*, 2013, Antoine Leperlier, cast glass, pâte de verre and ceramic, using Chinese colours, evokes spattered Chinese 'ink' with a red chop on a white background, as paper, 30x30x9cm. Source: antoine-leperlier.com, œuvres 2013125

- Figure 109 *Chair et Os XXIX*, 2016, Antoine Leperlier, cast glass, evokes brush and ink wash and tall, sheer Chinese landscape mountains, 27x27x10cm. Source: antoineleperlier.com, œuvres 2016.....126
- Figure 110 *Shanghai Opener*, 2012, Guillaume and Sophie LePenher, cast glass and yew wood, Shanghai World Financial Centre form, symbol of modern Shanghai, 109x12x12cm. Source: <http://www.behance.net/lepenher>127
- Figure 111 *Passage #1*, 2012, Guillaume and Sophie LePenher, yew wood and cast glass, mirror-image seal script characters, 51x34x11cm. Source: www.behance.net/lepenher128
- Figure 112 *Oval Blacknet #1*, 2006, Tobias Møhl, blown glass showing spontaneous and gestural threadlike 'ink' lines, evoking Asian cloud motif, approx. dimensions 23x37x14cm. Collection: Corning Museum of Glass (2006.3.65).....129
- Figure 113 Northeast Asian cloud motif. Source: pngtree.com/freepng/clouds-decorative-figure_619698.html129
- Figure 114 *Red Happiness*, 2005, Sunny Wang, blown and cut glass, abstracted character for 'double happiness' 囍, 27x23x19cm. Source: <http://www.statesofillumination.com/dr-sunny-wang/>.....129
- Figure 115 *5 Element Guard*, 2002, Anthony Scala, cast and coldworked glass, Chinese sword guard (detail), depicting the five elements in Chinese philosophy, rendered in accurate, unabstracted standard script characters. Source: [anthonyscalaglass.co.uk/Glass Swords...](http://anthonyscalaglass.co.uk/Glass%20Swords...)130
- Figure 116 *Ghost*, 2010, Ayako Tani, frameworked borosilicate, floating, three-dimensional Grass script-like calligraphy, H: 14cm. Source: ayakotani.co.uk.....130
- Figure 117 *Updraft Murmuration*, 2012, Sheila Labatt, cast crystal, bubbles displacing molten glass to cause movement in veiling, 34x21x8cm. Photo: Xiao Jin132
- Figure 118 罅 (hù), 2008, Sheila Labatt, cast crystal, the moment before the bubble fires out of the block, 16.5x11x11cm. Photo: Xiao Jin133
- Figure 119 *Inrush*, 2010, Mia Pearlman, paper, ink and clips, the third dimension represented in traditionally two-dimensional medium, 488x152x122cm. Source: miapearlman.com140
- Figure 120 *Murrine Rubik's Cube*, 2010, Robin Culbertson, fused and stretched glass, the design remains unchanged throughout the entire length of the hexagonal cane, as is revealed when the cane is sliced. Source: <https://i.pinimg.com/564x/f9/14/2d/f9142df595fd6d27647cfa4a06f24f5a.jpg>.....141
- Figure 121 *Ghost*, 2010, Ayako Tani, frameworked borosilicate glass, with wood frame that constrains the calligraphy and brings the work into the second-dimension, 15x21x4cm. Source: ayakotani.co.uk.....141
- Figure 122 Untitled, 2016, Sheila Labatt, kiln cast Glastma and Gaffer glass, veiling that partially obscures the 'ink' lines, Ø15x8cm. Photo: Sylvain Deleu146
- Figure 123 Untitled, 2016, Sheila Labatt, kiln cast Glastma and Gaffer glass, appealing veiling in contexts other than this research, 20x13x10cm. Photo: Sylvain Deleu.....146
- Figure 124 Bespoke, hot cast billet, 6x6x3cm, using 'black' Gaffer transparent powder that tuned purple due to thin application of colour. Photo: Sheila Labatt.....147

Figure 125 <i>Wash IV</i> (detail), 2016, Sheila Labatt, kiln cast Glastma and Gaffer glass, 'purple' billets like the one depicted in in Figure 124 turned blue, post firing, in an ink-wash effect, Ø15x20cm Photo: Sylvain Deleu	148
Figure 126 Good greyscale using Bullseye stringer and powder eggshells on Tekta, 60x60x6mm Photo: Sheila Labatt.....	148
Figure 127 <i>Krakatoa</i> (detail), 2013, Sheila Labatt, cast crystal, Kugler Colours powder, rendering full spectrum of black to light grey 'ink' washes, 27x19x8cm. Photo: Xiao Jin	148
Figure 128 Thin layer (less than 1mm) of opaque black, grey and white Kugler Colours powders, suspended in a rice gluten solution, applied to clear lead crystal slab (top view), ready for reassembly (with similar slabs) for casting, 2013, 19x8x(variable slab thicknesses)cm. Photo: Sheila Labatt.....	149
Figure 129 Eight slabs like the one in Figure 128, reassembled with powder inclusions, ready for taping and re-casting. Photo: Sheila Labatt	150
Figure 130 Preparation of elements for fusing, using 60x60x3mm Bullseye sheet glass (Tekta) and 2 and 1mm stringers. Photo: Sheila Labatt.....	151
Figure 131 Fused Bullseye element, stringers flush with the glass sheet. Photo: Sheila Labatt	151
Figure 132 Hot casting Glastma glass and flameworked Gaffer cane into refractory mould, inside kiln, pre-heated to 600. Photo: Sheila Labatt	152
Figure 133 Steel mould on marver, pre-heated by several 'throw-away' gathers, ready to accept molten glass. Photo: Sheila Labatt	152
Figure 134 Adding and manipulating cane inclusions with tweezers. Photo: Sheila Labatt ..	152
Figure 135 Flameworked inclusions, warming in a kiln, on the top surfaces of moulds, for quick inclusion into hot glass. Photo: Sheila Labatt.....	153
Figure 136 <i>Grass Script II</i> (detail), 2015, Sheila Labatt, manipulated, flameworked Gaffer cane inclusions in hot cast Glastma glass, diameter Ø15x15cm. Photo: Sylvain Deleu.....	153
Figure 137 Fused black ceramic enamel powder and acrylic medium painted onto slumped Glastma eggshells (about 1mm thick), in Asian cloud motif, 2012. Photo: Sheila Labatt.....	154
Figure 138 Block of hot cast glass (detail), 2012, with distorted eggshell inclusions showing spontaneous, gestural, brush and ink-like marks, 28x12x11cm. Photo: Sheila Labatt.....	154
Figure 139 Fused 2mm stringers, 60x60x6mm. Photo: Sheila Labatt.....	156
Figure 140 Fused black powder on Tekta, 60x60x6mm each. Photo: Sheila Labatt.....	156
Figure 141 Fused eggshells on Tekta, red circles designate good liquid ink-like effects, 60x60x6mm. Photo: Sheila Labatt.....	156
Figure 142 Bullseye dots fused on 3mm Tekta, in regular (left) and random (right) arrangements. 60x60x6mm each. Photo: Sheila Labatt.....	156
Figure 143 Four Bullseye flow test set-up configurations, with voids, in fabricated Ceraboard moulds (left column) and results (right column). Photos: Sheila Labatt.....	157
Figure 144 Diagram of glass flow results based on the different set-up configurations shown in Figure 143. Illustrations: Sheila Labatt.....	158
Figure 145 Stainless steel mould for hot casting billets, 6x6x3cm. Photo: Sheila Labatt	159

Figure 146 Custom clear and 'inky' billets [Figure 124] in conical refractory mould, ready for firing into a void at the bottom of the mould, held open by one horizontal billet. Photo: Sheila Labatt	159
Figure 147 Clear, slumped Glasma billet with fused cane. Photo: Sheila Labatt.....	159
Figure 148 Imagery inside dense, black block is revealed when cut, showing heavy ink-like effects associated with contemporary Chinese calligraphy. 10x8x2cm. Photo: Sheila Labatt	160
Figure 149 <i>Kuafu Overtaking the Fleeting Rays of the Sun #20</i> , 2001, Wang Dongling 王冬龄, ink on paper, heavy application of ink in contemporary Chinese calligraphy, 138x261cm. Source: bonhams.com/auctions/15409/lot/4468/ © Bonhams 2001-2018.....	160
Figure 150 Thin slices from a dense, seemingly 'black' block, appearing blue, assembled and fused to resemble high-ratio format and flowing mountain imagery in traditional Chinese landscape scrolls. 33x10x2cm. Photo: Sylvain Deleu.....	160
Figure 151 Deep, narrow holes in the bottom of a mould, created using the lost wax process, cause bubbles to rise when air is trapped by molten glass. Photo: Sheila Labatt.....	161
Figure 152 <i>Out of the Box</i> (detail), bubbles from bottom of mould, Photo: Sylvain Deleu.....	161
Figure 153 <i>Out of the Box</i> , 2015, Sheila Labatt, hot cast Glasma furnace glass and flameworked Gaffer cane, holes in bottom of mould created air bubbles, moving cane inclusions to create gestural tapers. Photo: Sylvain Deleu.....	161
Figure 154 <i>Out of the Box III</i> , 2015, Sheila Labatt, Glasma furnace glass and flameworked Gaffer cane, nail plunger created divots to trap air, creating bubbles to move cane inclusions into gestural tapers. Photo: Ester Segarra	162
Figure 155 Wooden plunger with chilled nails quickly cools molten glass to create depressions that will become air pockets, then bubbles, when the next layer of molten glass covers them. Photo: Sheila Labatt.....	162
Figure 156 Placement of nails in wooden plunger, diagram from studio notes. Sketch: Sheila Labatt	162
Figure 157 <i>Out of the Box II</i> , 2015, Sheila Labatt, sodium bicarbonate creates carbon dioxide bubbles that run through cane inclusions during hot casting, creating 'seed' bubbles (upper third) that remained trapped inside the piece. Photo: Ester Segarra.....	163
Figure 158 Sliced and drilled lead crystal slabs, with powder, ready to accept next slabs, to rebuild the block. Photo: Sheila Labatt.....	165
Figure 159 <i>Shan Shui</i> 山水 #5, 2008, Sheila Labatt, fired crystal and Kugler Colours powders, demonstrating bubble travel dragging colour asymmetrically, due to varying slab depths and hole diameters and placement. 24x15x5cm. Photo: Xiao Jin.....	165
Figure 160 Equal and opposite flow. Sketch: Sheila Labatt.....	166
Figure 161 <i>Ink Pot</i> , 2010, Sheila Labatt, cast crystal and Kugler Colours powders, rising bubbles push colour inclusions down, demonstrating equal and opposite reactions. 21x6x5cm. Photo: Sheila Labatt.....	166
Figure 162 Shallow, sandblasted grids, filled with black ceramic enamel powder. Photo: Sheila Labatt	167

Figure 163 Grid cut on the lathe to a depth of 1.5mm and filled with black glass powder. Photo: Sheila Labatt.....	167
Figure 164 Untitled, 2013, Sheila Labatt, Glasma furnace glass and ceramic enamel, shallow sandblasted grid caused black powder to turn blue due to light application of colour. 10x6x6cm. Photo: Sylvain Deleu.....	167
Figure 165 Untitled, 2013, Sheila Labatt, Glasma glass and ceramic enamel, deeper lathe-cut grid with heavier application of colour gives blacker, dramatically different result. 5x7x7cm. Photo: Sheila Labatt.....	167
Figure 166 Holes drilled through blunt, sharp and irregular ends of Bullseye stringer inclusions. Photo: Sheila Labatt.....	168
Figure 167 Untitled, 2013, Sheila Labatt, cast Bullseye Tekta and stringers, gestural, even tapers caused by bubbles dragging broken stringer tips, 6x6x6cm. Photo: Sylvain Deleu.....	168
Figure 168 <i>Da Shan Shui</i> 大山水, 2009, Sheila Labatt, cracked 'bubble' piece, with brush and ink-like 'grue' inclusions, 26x64x8 cm. Photo: Xiao Jin.....	169
Figure 169 <i>Tsunami</i> , 2010, Sheila Labatt, crystal and Kugler Colours powders, re-fired object into an oversized mould with a completely different form, creating a new ink-like effect. 14x71x11 cm. Photo: Xiao Jin.....	170
Figure 170 <i>Grass Script II</i> , 2015, Sheila Labatt, cast glass and frameworked inclusions, Ø15x15cm, ¾ front view. Photo: Sylvain Deleu.....	173
Figure 171 <i>Biographies of Lian Po and Lin Xiangru</i> (detail), c.1095, Huang Tingjian, ink on paper, Grass script calligraphy, showing fluid, gestural and spontaneous strokes with a good balance of ink and 'blank' space, 34x1,840cm handscroll. Collection: The Metropolitan Museum of Art, New York (1989.363.4).....	174
Figure 172 <i>Grass Script II</i> , ¾ view, translucent exterior softens the inclusions, facets cut to 90° for balanced profile, Photo: Sheila Labatt.....	175
Figure 173 Frameworked Gaffer cane inclusions. Photo: Sheila Labatt.....	176
Figure 174 Surface bubbles to be ground out during coldworking. Photo: Sheila Labatt.....	177
Figure 175 <i>Ink Pot II</i> , 2015, Sheila Labatt, cast glass, Ø15x15cm. ¾ view. Photo: Sylvain Deleu.....	178
Figure 176 Untitled (detail), 2006, Wang Dongling, ink on paper, heavy application of ink, in broad, dynamic, slashing strokes, covering most of the page, 125x210cm. Credit: Michael Goedhuis Gallery.....	178
Figure 177 <i>Wash IV</i> , 2016, Sheila Labatt, cast glass, Ø15x20cm. Photo: Tania Dolders.....	180
Figure 178 <i>Mountains Hidden in Clouds and Mist</i> , 2008, Li Huayi, ink and colour on paper, this contemporary Chinese landscape is moodier than traditional Chinese landscape painting, evokes the sublime and maintains a good balance of traditional blank and painted space, 120x240cm. Source: Beijing Centre for the Arts.....	181
Figure 179 Mostly vertical billet placement, inside mould, leaving a large void at the bottom into which the glass flowed. Studio sketch.....	182
Figure 180 Untitled, Ming Dynasty (1368 to 1644), Mo Shilong, brush and ink calligraphy on gold paper, fan shape. Collection: Honolulu Museum of Art (4019.1).....	183

Figure 181 <i>Fan</i> , 2014, Sheila Labatt, cast glass, 30x19x5cm. Photo: Sylvain Deleu.....	183
Figure 182 Huáng 璜, Warring States period (500–201 BC), carved jade, 12.2cm (length). Collection: National Palace Museum, Taipei (購玉 000536N000000000)	184
Figure 183 With its reflection, <i>Fan</i> resembles a <i>bì</i> Photo: Sylvain Deleu	184
Figure 184 Truncated triangular cross section of fired cone. Photo: Sheila Labatt.....	185
Figure 185 Arrangement of triangular segments in fan-shaped mould. Photo: Sheila Labatt	185
Figure 186 <i>Fan II</i> , 2014, Sheila Labatt, cast glass, 30x19x5cm. Photo: Ester Segarra	187
Figure 187 <i>Shanshui</i> , c1960s, Fu Baoshi, ink and colour on paper, contemporary, menacing landscape on fan, 14x43cm. Source: nipic.com/show/2/27/2189dee9638000d6	187
Figure 188 Nearly opaque cone, showing few brush and ink characteristics. Photo: Sheila Labatt	189
Figure 189 Truncated cone section revealing apparent wash and line imagery. Photo: Sheila Labatt	189
Figure 190 Triangular sections in fan-shaped mould, arranged to form a 'wash' continuum. Photo: Sheila Labatt.....	189
Figure 191 <i>Flying White</i> , 2013, Sheila Labatt, cast glass, 19x13x6cm, Photo: Sheila Labatt	190
Figure 192 Block showing lengths of cane sandwiched between hot cast gathers. Photo: Sheila Labatt.....	191
Figure 193 Arrangement of drilled segments back into a block for taping and re-firing. Photo: Sheila Labatt.....	191
Figure 194 Damaged <i>Flying White</i> ready for re-firing into a new form, with plenty of space inside the mould for the glass to flow. Photo: Sheila Labatt.....	192
Figure 195 Re-fired <i>Flying White</i> [Figure 191], shows no characteristics of the original inclusions. Photo: Sheila Labatt.....	193
Figure 196 <i>Out of the Box III</i> , 2015, Sheila Labatt, cast glass, 15x10x10cm. Photo: Ester Segarra.....	194
Figure 197 <i>Parallax</i> , 2013, Sheila Labatt, cast glass, Ø15x8cm. Photo: Ester Segarra.....	196
Figure 198 <i>Parallax</i> (detail), inclusions are distorted and appear farther away because of concave lenses. Photo: Ester Segarra.....	197
Figure 199 Bubbles showing on surface of hemisphere after hot casting and prior to grinding. Photo: Sheila Labatt.....	199
Figure 200 <i>Bonzai</i> , 2013, Sheila Labatt, cast glass, 10x7x7cm. Photo: Ester Segarra.....	201
Figure 201 <i>Willow Tree</i> , 1754, Jin Nong, ink on paper, 'bird and flower' ink painting on paper, showing delicate branches and leaves that appear in traditional landscapes, 25x32cm. Collection: Tianjin Municipal Art Museum, Tianjin	202
Figure 202 Assembly and orientation of elements, showing location of drilled hole, sketch from studio notes	203
Figure 203 <i>Krakatoa</i> , 2013, Sheila Labatt, lead crystal, 27x19x8cm. Photo: Xiao Jin	205
Figure 204 Preparation of glass slabs, filling grids (top right) and coating remaining surfaces with glass powder and acrylic impasto medium mixture. Photo: Sheila Labatt.....	207

Figure 205 Welded, single-use, mild steel box used to support the mould and heavy molten lead crystal. Photo: Sheila Labatt208

Figure 206 Curved continuum, graph showing the temperature relative to specific volume of a given glass, in relation to its viscosity. Source: Steven Weinberg223

Figure 207 *Green Amplexor*, 2011, Alicia Lomne, fragile and hollow pâte de verre, fused glass frit does not flow freely, 21x15x17cm. Source: alicialomne.com/224

Figure 208 *Mother Earth*, nd, Kimiaki and Shin-Ichi Higuchi, pâte de verre, hollow yet robust, 71x34x34cm. Source: <https://www.cmog.org/bio/kimiake-higuchi>224

LIST OF PLATES

Plate 1	<i>Xiao Shan Shui</i> (小山水), 2014, Sheila Labatt, 11x8x2cm. Photo: Sylvain Deleu.....	351
Plate 2	<i>Wash IV</i> , 2016, Sheila Labatt, Ø15x20cm Photo: Sylvain Deleu	352
Plate 3	<i>Grass Script II</i> , 2015, Sheila Labatt, Ø15x15cm Photo: Sylvain Deleu.....	353
Plate 4	Untitled, 2014, Sheila Labatt, 20x13x10cm Photo: Sylvain Deleu.....	354
Plate 5	<i>Ink Pot</i> , 2015, Sheila Labatt, Ø15x15cm Photo: Sylvain Deleu.....	355
Plate 6	<i>Fan II</i> , 2014, Sheila Labatt, 30x19x5cm Photo: Sylvain Deleu.....	356
Plate 7	Untitled, 2015, Sheila Labatt, Ø15x15cm Photo: Sylvain Deleu.....	357
Plate 8	<i>Fan</i> , 2014, Sheila Labatt, 30x19x5cm Photo: Sylvain Deleu.....	358
Plate 9	<i>Parallax</i> , 2013, Sheila Labatt, Ø15x7.5cm Photo: Ester Segarra.....	359
Plate 10	<i>Out of the Box II</i> , 2015, Sheila Labatt, 15x10x10cm Photo: Sylvain Deleu.....	360
Plate 11	<i>Bonzai</i> , 2013, Sheila Labatt, 10x6.5x6.7cm Photo: Sylvain Deleu	361

I INTRODUCTION

1. Impetus for the Project

My fascination with graphic, expressive and mostly monochrome paintings and prints, such as those of Robert Motherwell and Franz Kline, began years before I moved to Korea (1997–2003), and subsequently to China (2003–2010).

While living in Korea, I discovered the beauty, balance and importance of brush and ink calligraphy. This set me on a journey into the history, aesthetics and personal practice of Chinese calligraphy, considered the highest art form across Northeast Asia.¹ I learned to speak and write Korean and Mandarin Chinese, allowing me not only to earn art degrees in Seoul and Shanghai but to also explore Chinese calligraphy in greater depth.²

My interest in traditional Chinese landscape painting came later, while I was studying glassmaking at Shanghai University under Professor Zhuang Xiaowei, father of the Chinese Studio Glass movement.³ I had been experimenting with

¹ I refer to Chinese calligraphy because traditional calligraphy practice throughout Northeast Asia (China, Korea and Japan) uses Chinese characters and has the same, originally Chinese, brush and ink traditions. In addition to Chinese characters, Korean and Japanese practice includes their respective, distinctive scripts, which were developed millennia after Chinese characters had been adopted: Hangul (한글) was invented in Korea in 1446 AD and is one of the most phonemic spelling systems in the world. In Japan, Hiragana (ひらがな), originally used by women, was adapted from Chinese characters in the fifth century and Katakana (カタカナ), originally reserved for men, was adapted, also from Chinese characters, in the ninth century.

² I earned a BA in Metal Art and Design from Hong-ik University (2001) and an MA in Glass from Shanghai University (2010); I remain the only Westerner to have done so in either university.

³ Vanessa Lee Taub, *Artist Zhuang Xiaowei: The Father of Chinese Contemporary Glass Sculpture*, 2011

<https://www.youtube.com/watch?v=Z5GM93gah_A>. [accessed 21 September 2017]. Professor Zhuang established the first art glass studio in Mainland China, at the Fine Arts College of Shanghai University (2000), and was the Founding Director of the Shanghai Museum of Glass (2008). He is considered the co-founder of the Chinese Studio Glass movement, with Guan

trapping air bubbles inside cast glass when I observed veiling in the upper third of a test piece [Figure 1]⁴ that evoked Huangshan (黄山, Yellow Mountain) [Figure 2], a steep, oft-depicted mountain in Chinese landscape painting [Figure 3].



Figure 1 *Huangshan*, 2005-2006, Sheila Labatt, cast glass, milky veiling in upper third resembles the top of Mount Huangshan, 23x6x6cm. Photo: Xiao Jin



Figure 2 *Huangshan (Yellow Mountains)*, 2007. Photo: ©Aaron D. Feen



Figure 3 *Memories of Mt. Huangshan*, 1961, Zhang Daqian, ink and colour on paper, 137x69 cm hanging scroll.

Source: sothebys.com/en/auctions/ecatalogue/lot.1226
© 2018 Sotheby's

Since then, I have continued to seek methods for evoking ink and Chinese landscape painting inside cast glass.⁵

This research is the culmination of twenty years' appreciation of Chinese calligraphy and over ten years' exploration into evoking ink and Chinese landscape painting inside cast glass.

Donghai, Associate Professor and Head of Glass at Qinghua (Tsing Hua) University, Beijing.

⁴ Veiling is a milky field inside cast glass, often at the intersection of billets or cut elements used in the casting process.

⁵ See Chapter V – Techniques Explored in this Project

2. Aims and Scope

A primary objective of the project is to not only revisit aspects of brush and ink, and line and wash in a new medium, but to transpose them into the third dimension. It is outside the scope of the research to review the many artists and scholars who have explored translating two-dimensional media into the third dimension. For the purposes of the project, it is more important to establish a method for assessing whether inclusions, which are fully encased in a transparent material such as glass, are indeed three-dimensional. I therefore use basic Euclidean geometry principles to devise a method for determining the dimensionality of elements that cannot be assessed by touch.

In this research, I also investigate the ability of cast glass to exhibit spontaneous qualities, using ink-like inclusions as a visual reference. Ink, in this context, refers to Chinese brush and ink painting characteristics that evoke calligraphy and traditional landscape painting, in the third dimension.

The ink qualities used to gauge spontaneity are those found in the gestural, flowing lines of Grass script calligraphy⁶ and, in landscapes, the 'Five Colours of Black' ink wash technique.⁷

The history of Chinese painting spans millennia and my purpose is not to survey Chinese art history or discuss symbolism. Instead, I limit my discussion to schools of calligraphy and landscape painting whose characteristics illustrate the line and wash qualities that contextualise my research.

In addition to ink imagery, cast glass and spontaneity are key elements. Although glassmakers agree that casting refers to hot, liquid glass that takes on the shape of a mould, my research indicates that opinions vary as to what additional glassmaking techniques constitute casting. I therefore develop my

⁶ See Chapter III – Ink > Line > Grass Script (cǎoshū 草书)

⁷ See Chapter III – Ink > Wash > Wash Qualities

own working definition, to establish the technical parameters of the project.⁸

Spontaneity is another elusive concept in the context of this project. I therefore review definitions and theories on the subject, both Eastern and Western, to address the possibilities for spontaneity in cast glass and to supplement my analysis of Grass script calligraphy and landscape painting.

3. Thesis

As a lawyer-turned-artist, I rely on rules and definitions to help me navigate the world. Chapter II therefore analyses a range of definitions of two critical elements in the title of the project: casting and spontaneity.

Beyond the accepted notion that casting requires liquid glass and a mould, the breadth of opinion as to what else constitutes casting is surprising, given that the Studio Glass movement is now over 50 years old.

My research reveals that the only agreed-upon element is that the glass casting process must include the use of a 'mould'. I therefore analyse definitions of moulds and mould-making, which show a similar dearth of consensus. The research having yielded inconclusive results, I establish my own working definitions of 'casting' and 'moulds', which are essential for setting the technical parameters of the project.

'Spontaneity' also requires defining because it is key to the aesthetic aspect of this research. Dictionary definitions are unhelpful in that they do not apply well to the expressive arts and only lead me to believe that nothing is truly spontaneous. Even the 'butterfly effect' in Chaos Theory is not truly spontaneous because it can notionally be described by fractal mathematics.⁹

⁸ See Chapter II – Casting, Spontaneity and Flow > Casting Definition and Context

⁹ See Chapter II – Casting, Spontaneity and Flow > Spontaneity and Flow: Elusive Immediacy in Cast Glass > Spontaneity and Flow: A Working Definition

As with casting and mould-making, I therefore combine elements of various definitions and philosophies to arrive at my own, more satisfactory working definition, which helps underscore that only *apparent* spontaneity is possible in glass casting.

Although spontaneity is not strictly possible when casting glass forms, it can be made visible in the flow of molten glass. ‘Flow’ also occurs when an artist is completely immersed in their work and in the heightened state of focus described by Mihály Csikszentmihályi as the ‘Zone’.¹⁰

The Daoist philosophy of *wúwéi* (无为), doing through not doing, describes a similar state in which a person is so absorbed in their task that they feel as though they are doing nothing. The difference between the two is that in Daoist philosophy a person in a state of *wúwéi* radiates virtue (德 *dé*), whereas someone in the Zone is considered ‘optimally happy’. Therefore, *wúwéi* describes one’s outward character; the Zone centres on the individual. Yet both are reflected in artistic output.

The Japanese philosophy of *shibusa* (渋さ) best describes spontaneity in the context of this research. In Japanese aesthetics, ultimate beauty in art lies on a continuum between ‘restraint’ and ‘exuberance’, closer to the restraint end. *Shibusa*, sometimes called ‘restrained spontaneity’, distinguishes between two types of spontaneity: spontaneity of *action* and spontaneity of *effect*. I consider spontaneity of action to be *true* spontaneity and spontaneity of effect to be *apparent* spontaneity.

Spontaneity in the context of this research is spontaneity of effect, or apparent spontaneity. It is evaluated based on the characteristics of brush and ink calligraphy and landscape, as executed by an artist in the state of *wúwéi*, exhibiting virtue (德 *dé*), and painting with *shibusa*’s spontaneity of action – true spontaneity.

¹⁰ See Chapter II – Casting, Spontaneity and Flow > Spontaneity and Flow: Elusive Immediacy in Cast Glass > Spontaneity of Effect, *shibusa* (渋さ) and *wúwéi* (无为)

Chapter III describes the characteristics of Chinese ink painting that I use to evaluate the research results. I introduce the work of contemporary artists who are reinterpreting traditional calligraphy and landscape using non-traditional materials. I also describe the characteristics of calligraphy and landscape that underpin this research.

Grass script calligraphy is the most gestural and spontaneous of the Chinese scripts, as well as the most difficult to execute (and read), because it is highly abstract and requires the artist to be in the state of mind described by *wúwéi*. The 'ink' line inclusions in the work are based on this script.

Chapter III also explains traditional Chinese landscape painting in terms of *ink wash* characteristics that, along with those of Grass script lines, comprise the aesthetic aim of the research. I also introduce the most important 'colour' in landscape painting – white – in which leaving blank space on the paper or silk is heavily influenced by Daoist philosophy.

Chapter III concludes with a discussion of dimensionality. I analyse mathematical principles and review ostensibly three-dimensional art works to illustrate the difficulty of rendering Chinese painting in the third dimension. A further complication arises in determining the dimensionality of inclusions inside a transparent medium, such as glass, because one cannot touch the inclusions. In this chapter, I therefore establish my own rules for confirming that the inclusions in my work are indeed three-dimensional.

In Chapter IV, I review aspects of Chinese glassmaking history that have had a direct effect on the contemporary Chinese Studio Glass movement and on my own work, since I was part of the early days of that movement. To further contextualise my work, I also introduce and discuss work by glassmakers, both Chinese and Western, who are exploring ink, calligraphy or landscape painting in glass.

Chapter V explains my research methodology and provides technical details for my exploration of apparent spontaneity, flow and brush and ink painting in the

third dimension.

Chapter VI reviews results, in selected finished pieces, that exemplify the techniques described in Chapter V, and includes detailed technical notes. I also evaluate each piece, based on the criteria set out in the body of the thesis.

Chapter VII summarises the thesis, by chapter. It sets out original contributions to knowledge that this research has generated and suggests promising avenues for further investigation.

The dating system for Chinese art history, the romanisation¹¹ system I use and people's names, as they are recorded in this thesis, are explained in Appendix I. Appendix II summarises the peculiar relationship between amorphous solids and temperature. I argue for *pâte de verre* as a fusing technique in Appendix III. Appendix IV is my CV, which illustrates my participation in the early years of the Chinese Studio Glass movement. Appendix V is a complete transcription of my studio notes, with firing schedules, sketches, photographic images and commentary on test results. Appendix VI is a selection of plates showing the creative output of the project. This is followed, in Appendix VII, by a glossary of terms as they are used in this thesis and a selected bibliography of material consulted in the course of my research.

¹¹ Transliteration into the Latin alphabet.

II CASTING, SPONTANEITY AND FLOW

1. Introduction

The 'casting process' establishes the technical scope of this research and 'spontaneity' describes some of its aesthetic aims. Both ideas appear in the title of the project and are addressed in this chapter. I discuss 'ink', the third term in the title, separately and in greater depth in Chapter III.

Glassmakers agree that casting involves liquid glass that takes on the shape of a mould. Opinions vary, though, as to which additional glassmaking techniques fall within the scope of casting and, as a consequence, what constitutes a mould. This chapter discusses some of these views and explains how I arrive at a working definition of casting, which is essential for establishing the technical parameters of this research.

The chapter also reviews my investigation into 'spontaneity' and 'flow', to contextualise my studio work, within both Western theory and Northeast Asian philosophy.

2. Casting Definition and Context

a) Introduction

Glass casting is the process of introducing fully molten glass into a mould. As the glass cools, it retains the negative shape of the mould and the resulting object is considered *cast glass*. This can be achieved in a variety of ways, either using a kiln to heat the glass or using liquid glass, gathered from a furnace.

Two common kiln casting methods include:

1. melting chunks of glass (billets) that have been placed inside a mould at room temperature, and
2. melting room-temperature glass pieces in a reservoir, which is suspended above a mould – such as an ordinary flowerpot, with a hole in the bottom – allowing molten glass to flow through the hole and into the mould. In both cases, the glass takes on the form of the mould.

Liquid glass can also be gathered from a crucible inside a furnace and poured or drizzled into a mould. As with kiln casting, the glass adopts the form of the mould and is considered cast glass.

Some glassmakers include additional techniques, such as fusing and slumping, in their understanding of the casting process and the cast object.

The lack of a generally-accepted and *exhaustive* definition of casting creates a problematic ambiguity that, in the context of this project, would have opened too many avenues for exploration.

To narrow the technical parameters of my research, I survey different views on the *cast object* in terms of relative weight and density and the *casting process* in terms of temperature. Since many hot and warm glassmaking techniques have been described (accepted or rejected) as casting, I conclude that no generally-accepted, comprehensive definition exists. I therefore arrive at a working definition, for the purposes of this project, based on my review of others' definitions of casting and mould-making and on my own glassmaking experience.

I then further refine the technical framework for the project by establishing the temporal placement of casting, as I have defined it, within hybrid processes that I use to create each piece.

b) *Casting Definition*(i) *The Cast Object: Relative Weight and Density*

John Perreault has written that cast glass refers to a 'solid' glass object, which he defines in terms of 'weight, mass and quiet presence'.¹² In addition to glass being solid to the touch at room temperature, his understanding of solidity refers to an unspecified size to weight ratio in which cast glass must be heavy relative to its dimensions.

The trouble with this view is that large, otherwise heavy works can be hollow and



Figure 5 *Stella* candle holder, 1960s, Sven Palmquist for Orrefors, blown crystal. The centre hole is the diameter of a pencil, making the piece dense in relation to its size. Ø6.5x6cm.

therefore lightweight in relation to their size.

Likewise, small, relatively

light pieces can be heavy relative to their dimensions.

Karen LaMonte's ethereal, life-sized cast glass dresses [Figure 4], for example, weigh up to several hundred kilos but are hollow and therefore lightweight in relation to their size. She even describes them as 'gravity defying'¹³ and 'fragile',¹⁴ suggesting weightlessness and a lack of Perreault's 'solidity'.



Figure 4 *Evening Dress with Shawl*, 2004, Karen LaMonte, cast glass, hollow and lightweight relative to its size. 150x121x60cm. Collection: Corning Museum of Glass

¹² John Perreault, 'Portfolio: Cast Glass, Hot and Warm', *The UrbanGlass Art Quarterly*, 75 (1999), p. 35

¹³ Smithsonian American Art Museum, *Karen LaMonte: Artist Talk* (Smithsonian American Art Museum, Washington DC, 2010) http://americanart.si.edu/multimedia/video/lamonte/lamonte_talk.cfm?width=730&height=530 [accessed 14 December 2016]

¹⁴ Karen LaMonte, and Smithsonian American Art Museum, Interview: Cast Dresses, 2010

<http://americanart.si.edu/multimedia/video/lamonte/lamonte_interview.cfm?width=490&height=320> [accessed 16 January 2017]

In contrast, blown objects are usually lightweight in relation to their size. Vessel walls need not be thin, though, and blown work can have a high weight to size ratio, suggesting solidity [Figure 5].

Similarly, hot-sculpted objects are heavy in relation to their size because they are not usually hollow.¹⁵ John Sharvin's hot-sculpted work [Figure 6], for example, which references human interaction with nature, is one such example.¹⁶

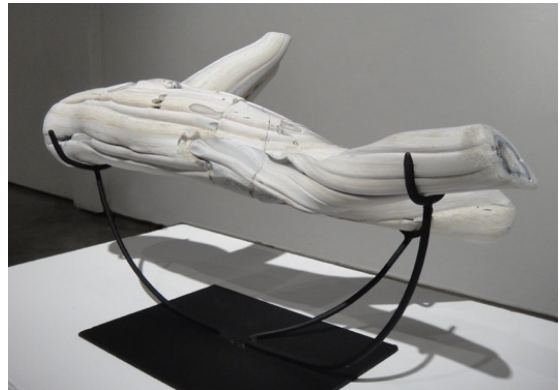

Figure 6 *Horizontal Outcast*, 2011, John Sharvin, hot-sculpted glass, dense in relation to its size, 55x22x30cm. Source: jessieblackmer.com/student-portfolio

Yet Perrault specifically characterises cast glass as falling in the realm of 'the solid as opposed to the hollow' and compares it to blown glass, metaphorically, as 'rock ice rather than [...] soap bubbles'.¹⁷

The Dictionary of Art states that glass 'casts are generally stronger, as well as lighter and cheaper, if hollow',¹⁸ suggesting that castings may of course be hollow. Daniel Clayman's cast works [Figure 7], for instance, have hollow interiors because, according to Matthew Kangas, 'mass and volume have never been defining criteria for him as a sculptor'.¹⁹



Figure 7 *Quiver*, 1998, Daniel Clayman, cast glass and bronze, mass and volume are not defining criteria, 23x53x24cm. Source: danielclayman.com/protection

¹⁵ In hot sculpting, molten glass is gathered and worked on a long, solid metal rod (a punty) as opposed to a blow pipe, which is used in glass blowing.

¹⁶ John Sharvin, 'Artist Statement', nd <<http://yeahsharvin.wix.com/sharvinglass#!statement>> [accessed 26 September 2017]

¹⁷ Perreault (1999)

¹⁸ Jane Turner, ed., *The Dictionary of Art*, 34 vols (New York: Grove, 1996), vi

¹⁹ Matthew Kangas, 'Daniel Clayman: The Object Is the Image', *The UrbanGlass Art Quarterly*, 75 (1999), p. 40

Furthermore, hollow cast pieces can be as thin-walled as blown work. Examples can be seen in ancient cast bowls [Figure 8] and in Ann Robinson's *Pacific Bowl*, which was cast using about 50kg of glass but whose walls are relatively thin [Figure 9].²⁰



Figure 8 Achaemenid Persian Phiale (shallow bowl), c. 450–330 BCE, cast glass, hollow and thin-walled, Ø17.5x3.2cm. Collection: Corning Museum of Glass (59.1.578)



Figure 9 *Pacific Bowl*, 1991, Ann Robinson, cast crystal glass, thin walls in relation to weight, Ø64.5x30.5cm. Museum of New Zealand Te Papa Tongarewa, Wellington (1996-0033-32)

(ii) *The Casting Process: Relative Temperature*

A cast object cannot, therefore, be defined simply as *solid* or distinguished based on whether it is heavy or light, thick or thin, or hollow. It must be defined as a 'reproduction of a three-dimensional object²¹ produced by means of a *mould*'.²²

To help define the cast *object*, I looked to the casting *process* itself.

My research revealed that there is no agreed temperature needed for casting. The only consensus is that a heat resistant refractory mould is required.²³

²⁰ Dowse Art Museum, *Ann Robinson Casting Light: A Survey of Glass Castings, 1981-1997* (Lower Hutt, Aotearoa, NZ: The Dowse Museum, 1998), Exhibition Catalogue

²¹ I define the third dimension for the purposes of this research in Chapter III – Ink > Ink and the Third Dimension

²² The Dictionary of Art, volume IV

²³ Refractory moulds are made from mixtures of plaster and heat-resistant materials. They begin to deteriorate around 900°. Recipes for refractory

Since different glassmaking techniques use moulds to form glass at a variety of temperatures, I needed to establish a temperature range (and viscosity level) within which to conduct my research and to deem my work *cast*.

Using moulds with fully liquid glass (about 835° Celsius and above, depending on the type of glass)²⁴ is typically considered casting. In kiln and hot casting, for example, glass flows freely 'into the recesses – and even into the finest intaglio designs of [a] mould'.²⁵

Some glassmakers consider additional techniques as casting. Perreault, for instance, defines casting to include fusing (about 760°–820°, not hot enough to flow freely)²⁶ but excludes other, even lower-temperature processes.²⁷

Steven Weinberg,²⁸ Lucartha Kholer²⁹ and Bill Gudenrath³⁰ hold the most liberal view of casting and include slumping³¹ (between about 600° and 700°, working

moulds can be found in, Angela Thwaites, *Mixing with the Best: Investigation and Comparison of Contemporary Working Methods and Mould Making Materials for Use in the Kiln Forming of Glass* (London: Arts and Humanities Research Board, Royal College of Art, 2002), p. (CD)

²⁴ Temperatures for various techniques are given in ranges because different effects, such as fusing and slumping, can be created at different temperatures depending on the desired effect and the composition and thermal properties of the glass being used.

²⁵ Hugh Tait, ed., *5000 Years of Glass* (London, UK: British Museum Press, 2012), p. 267

²⁶ Fusing occurs when pieces of glass are hot enough for their surfaces to liquefy and bond with each other but are not hot enough to flow. Fusing can involve a mould but can also be executed flat, on a kiln shelf, which is not a 'mould', as I define it in the next subsection. I believe that fusing includes the *pâte de verre* technique. My arguments are set out in Appendix III – *Pate de verre* Technique as Fusing.

²⁷ Perreault, p. 35

²⁸ Steven Weinberg, 'Glass Casting Techniques', *Glass Art Society Journal*, 1985, p. 100

²⁹ Kohler, p. 60

³⁰ Bill Gudenrath interview with Sheila Labatt re: Casting Definition, Corning Museum of Glass, 21 June, 2013

³¹ Slumping, also known as 'sagging', is the process of heating glass to working temperature, when it becomes soft and gradually bends under its own weight to take on the form of a mould into or over which it moves. It is not hot enough to flow freely.

temperature) [Figure 10].³² Gudenrath, for instance, believes that casting is ‘a process in which *softened glass* is made to conform to the shape of a mould’, which therefore includes fusing and slumping.

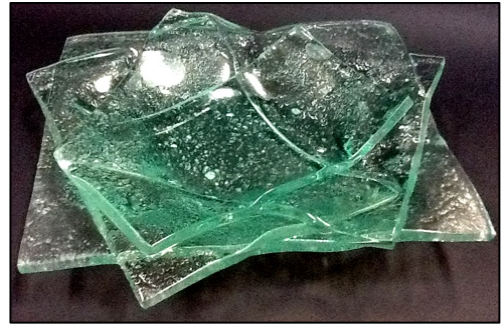

Figure 10 Title unknown, 2012, Ian Whittaker, float glass slumped at working temperature (without flowing) into a sand mould, dimensions unknown. Source: ianwhittaker.com/glass-slumping

If temperature and viscosity were the defining criteria for casting, the glass community would have agreed upon a figure or formula to define the process. To date, no such figure or formula has been established.³³

The range of techniques, across various temperature ranges, that ostensibly define the casting *process* is too broad to establish the parameters for this project, particularly since different types of glass require different firing schedules. I have, therefore, limited my casting definition to cases in which the temperature is high enough to liquefy the glass, allowing it to flow freely. I therefore do not consider slumping or fusing to be casting processes.³⁴

c) *What is a Mould?*

Cast *objects* cannot be defined in terms of form or mass and the casting *process* cannot be explained by temperature or its effect on the viscosity of different types of glass. I therefore looked to the definition of moulds because,

³² Working temperature is a range of temperatures at which warm or hot glass is soft enough to move and be shaped.

³³ Such an exercise would be futile for studio purposes, in any event, since one of the properties of glass, as an amorphous solid (see Appendix II), is that its viscosity is impossible to measure in a studio setting. It is even difficult to measure, in a laboratory. See: Ozgur Gulbilen, John C. Mauro, Olus N. Boratav, and Guo Xiaojun, ‘Viscous Flow of Medieval Cathedral Glass’, *Journal of the American Ceramic Society*, 2017, pp. 1–7

<http://onlinelibrary.wiley.com/doi/10.1111/jace.15092/epdf?r3_referer=wol&tracking_action=preview_click&show_checkout=1&purchase_referrer=onlinelibrary.wiley.com&purchase_site_license=LICENSE_DENIED> [26 September 2017]

³⁴ This definition aligns with the Corning Museum of Glass website, which defines ‘slumping’ and ‘fusing’ separately from ‘casting’ on their website.

as Shawn Waggoner writes (and many others concur), '[...] you don't just cast glass. What casting really means is that you're involved in a moldmaking process [...]'.³⁵

The narrowest definition addresses form. Harriette Anderson writes that 'two major requirements for molds that have contour [...] are that the inside bottom of the mold be flat and the walls have a gentle slope.'³⁶ Judith Conway, though, holds the more generally-accepted view that the 'correct combination of heat, time and gravity will allow the glass to gently conform to almost any shape of mould'.³⁷

Since *form* is not the defining criterion for a mould, one must look instead to its *function*. Weinberg, as a kiln casting glassmaker, writes that a mould must be a negative physical form.³⁸ Glassblower Lorin Silverman, though, believes that a mould can also include tools that can contain glass while it is being blown. He says that 'jacks and a paddle'³⁹ for instance, constitute a mould because they force the glass into a given shape and allow the glass 'nowhere else to go' [Figure 11].⁴⁰



Figure 11 Lorin Silverman using jacks and paddle as a 'mould' to contain the glass (2013).
Video still: Sheila Labatt

³⁵ Shawn Waggoner, 'Larger Things to Come: The Cast Glass of John Lewis', *Glass Art*, 10 (1994), p. 59

³⁶ Harriette Anderson, *Kiln-Fired Glass*, 2nd ed. (McLean, VA: H. Anderson, 1997), p. 27

³⁷ Judith Conway, 'Kiln Forming Glass: An Intro to Glass Slumping', *Glass Craftsman*, October–November 2000, Rakow Library CMOG, p. 30

³⁸ Weinberg (1985), p. 109

³⁹ Jacks and paddles are used, in glassblowing and hot sculpting, to form glass. Jacks are a large, metal, tweezer-shaped tool and a paddle is a flat, water-laden, wooden board. The two are often used in combination.

⁴⁰ Lorin Silverman interview with Sheila Labatt re: Moulds, Corning Museum of Glass, 4 September, 2013

I have adopted Silverman's premise that a mould must contain the glass, allowing it nowhere else to go.⁴¹ However, I disagree that his tools constitute a mould because, in glass blowing, the blow pipe rotates constantly. Were the pipe to stop, the glass would fall to the floor because it does, in fact, have 'somewhere else to go'.

d) *Temporal Placement of Casting*

I have delineated the parameters of my research by defining cast glass as a three-dimensional *object*, produced by means of a mould, and the casting *process* as requiring a negative mould that wholly contains liquid glass, allowing it 'nowhere else to go'.

The final issue in deeming when a piece is *cast*, for the purposes of the project, concerns when the casting element of the process occurs within a hybrid series of techniques.

In this project, cast pieces incorporate processes or elements which were created using non-casting techniques, such as flameworking.⁴² If these were included in glass that is cast, within my working definition, the result would be a cast object. If the reverse were to take place, where glass was first cast and then stretched into cane and/or flameworked, as far as that is possible, the result would no longer be cast glass, because the finished piece had not ultimately taken on the shape of a mould. In this project, the casting component must therefore be the final hot process in the chain.⁴³

⁴¹ See also: Kohler (1998), pp. 58–59, who contends that a mould must be strong enough to 'hold the glass' (contain it) as it becomes molten, behaving, in effect, like a 'mini glass tank'.

⁴² Flameworking, also known as lampworking, is a technique in which glass rods and tubes are softened and manipulated in the flame of a torch.

⁴³ Coldworking, in order to finish a piece through grinding and polishing, does not diminish its status as a 'cast' object.

3. Spontaneity and Flow: Elusive Immediacy in Cast Glass

Life is a series of natural and spontaneous changes.
Don't resist them [...]. Let reality be reality. Let things
flow naturally forward in whatever way they like.
Attributed to Laozi, 571–531 BCE

a) *Spontaneity and Flow: A Working Definition*

By most dictionary definitions, nothing is truly spontaneous.

The Oxford Living Dictionaries, for instance, define spontaneity as an action being 'performed or occurring as a result of a sudden impulse or inclination and without premeditation or external stimulus',⁴⁴ yet every apparently spontaneous action originates from an external stimulus. For example, a calligrapher's stroke begins with a momentary premeditation that is the external stimulus for her action. Many years' training is also an external stimulus because every practice session leads to each, apparently-spontaneous stroke.⁴⁵

Even in Chaos Theory, the butterfly effect, described by James Gleick, begins with an external stimulus – the batting of a butterfly's wings – that causes a chain of seemingly spontaneous weather reactions. These are not spontaneous, though, in that they can, in principle, be predicted by fractal mathematics.⁴⁶ According to Plato, 'God always geometrizes', meaning that

⁴⁴ 'Spontaneous', *Oxford Living Dictionaries* (Oxford University Press, 2017) <http://www.oxforddictionaries.com/definition/english/spontaneous#spontaneous_3> [accessed 31 March 2015]

⁴⁵ In *The Culture of Spontaneity*, Daniel Belgrad suggests that similar arguments can be made for all improvisational arts such as jazz music, modern dance and stream of consciousness writing. See: Daniel Belgrad, *The Culture of Spontaneity: Improvisation and the Arts in Postwar America* (Chicago: University of Chicago Press, 1998) pp. 35–39

⁴⁶ Nonlinear events (such as turbulence, weather or stock markets) are, in practice, impossible to predict. In theory, though, they can be described by fractal mathematics. Sources: Jonathan Wolfe, 'What Is Chaos Theory?', *Fractal Foundation*, nd <<http://fractalfoundation.org/resources/what-is-chaos-theory/>> [accessed 11 January 2017] and Geoffrey R. Goodson, *Chaotic Dynamics: Fractals, Tilings, and Substitutions*, Cambridge Mathematical Textbooks (Cambridge, UK ; New York, NY: Cambridge University Press, 2017)

there is order to everything in nature, whether it is apparent or not, and that nothing is truly spontaneous.⁴⁷

Other definitions concern ‘unpredictability’ and events ‘occurring without apparent external cause’.⁴⁸ These references are more apt in the context of this project because inclusions only *appear* to have moved without external cause. As in the butterfly effect, however, their distortions result from initial conditions – the preparation of a piece prior to casting – creating a chain of seemingly unpredictable reactions that causes glass to flow ‘of its own accord’.⁴⁹

The dictionary also defines a spontaneous *act* as occurring in an ‘open, natural and uninhibited manner’.⁵⁰ This definition characterises glass flow well and also describes Grass script calligraphy, which the inclusions in this project are intended to evoke.⁵¹

I have therefore assembled parts of each dictionary definition to arrive at the most appropriate one to describe the results of this research.⁵² Cast objects, as I have defined them, must contain apparently spontaneous inclusions that evoke brush and ink painting⁵³ and exhibit an ‘open, natural, and uninhibited’ aesthetic,⁵⁴ having occurred ‘without apparent external cause’⁵⁵ and without

⁴⁷ Widely attributed to Plato. See: Mandelbrot, Benoit B., ‘Fractals and the Geometry of Nature’

<http://users.math.yale.edu/~bbm3/web_pdfs/encyclopediaBritannica.pdf> [accessed 11 January 2017] p. 175

⁴⁸ ‘Spontaneous’, *Oxford Living Dictionaries* (Oxford University Press, 2017)

<http://www.oxforddictionaries.com/definition/english/spontaneous#spontaneous__3> [accessed 31 March 2015]

⁴⁹ Ibid.

⁵⁰ Ibid.

⁵¹ See Chapter III – Ink > Line > Chinese Calligraphy > Grass Script

⁵² See Chapter VI – Results

⁵³ Described in Chapter III – Ink

⁵⁴ ‘Spontaneous’, *Oxford Living Dictionaries* (Oxford University Press, 2017)

<http://www.oxforddictionaries.com/definition/english/spontaneous#spontaneous__3> [accessed 31 March 2015]

⁵⁵ Ibid.

being ‘tended or cultivated’.⁵⁶ Given that my process combines both control and unpredictability, the inclusions must, therefore, *appear* to have arisen ‘of their own accord’.⁵⁷

b) *Spontaneity of Effect, shibusu (渋さ) and wúwéi (无为)*

Dictionary definitions are only partially helpful in illustrating the aesthetic aims of this research. Examining theories that address spontaneity and flow in the art context is also useful.

Glass flow, which *evokes* gestural brush and ink lines and washes, constitutes ‘spontaneity of effect’ within the Japanese aesthetics philosophy of shibusu (渋さ). This theory holds that ultimate beauty in art lies on a continuum between restraint and exuberance and suggests that it belongs closer to the restraint end.⁵⁸ Shibusu, sometimes called ‘restrained spontaneity’,⁵⁹ also distinguishes between two types of spontaneity: spontaneity of action and spontaneity of effect.

Spontaneity of action comes from the artist’s hand as guided by their unconscious. I liken this to *true* spontaneity (to the extent that that is possible). Spontaneity of effect, on the other hand, is caused by an external event or stimulus, such as accidental ash contamination in a kiln or an inadvertent knock to a clay pot before it has dried.⁶⁰ Spontaneity of effect is similar to the *apparent* spontaneity that occurs when glass, having been arranged to produce a deliberate outcome, creates the *illusion* of spontaneity of action.

The Daoist (Taoist) philosophy of wúwéi (无为) refers to effortlessness (‘doing

⁵⁶ Ibid.

⁵⁷ Ibid.

⁵⁸ David E. and Michiko Young, *Spontaneity in Japanese Art and Culture* (BC: Canada: Coastal Tides Press, 2012), p. 104

⁵⁹ Ibid., p. 18

⁶⁰ Ibid

by not doing')⁶¹ and spontaneity.⁶² People in a state of wúwéi are in sincere absorption of their task.⁶³ They may feel as though they are doing nothing but could, in fact, be creating a masterpiece.⁶⁴

Mihály Csikszentmihályi identified a similar condition he calls 'the Zone' or 'flow', in artists who in are a state of 'heightened focus' and are so immersed in their work that they disregard necessities of life.⁶⁵ The difference between the Zone and wúwéi is the Zone is said to bring ultimate happiness,⁶⁶ whereas wúwéi carries an additional moral connotation. When people are 'optimally effective' in wúwéi, they 'radiate charisma and virtue', referred to as dé (德).⁶⁷ The Zone is therefore 'self' centred whereas dé is a quality of one's character and is outward focused.⁶⁸

The paradox in the latter theory is that 'the highest virtue does not try to be virtuous, and so really possesses virtue'.⁶⁹ In other words, the harder one tries

⁶¹ A thorough historical and philosophical discussion of wúwéi in the context of glass (pâte de verre) can be found in Qu Jin Ziqin 屈金, 'Developing Pâte de Verre Glass Art through the Chinese Philosophy of Wu Wei' (PhD Thesis, University of Sunderland, 2017)

⁶² Edward E. Slingerland, *Trying Not to Try: The Art and Science of Spontaneity* (New York: Broadway Books, 2014), pp. 8, 99

⁶³ Ibid., p. 205

⁶⁴ Ancient Advaita philosophy describes a similar state of intuition as 'free, and actionless consciousness'. Source: John Henry Richards, tran., *Ashtavakra Gita*, 2nd ed. (Abhaya Books, 2015) <<http://realization.org/p/ashtavakra-gita/richards.ashtavakra-gita/richards.ashtavakra-gita.html>> [accessed 11 January 2016], paragraph 1.12

⁶⁵ Mihály Csikszentmihályi, *Flow: The Psychology of Optimal Experience*, Harper Perennial Modern Classics (New York: Harper and Row, 2009)

⁶⁶ Mihály Csikszentmihályi, *Flow, the Secret to Happiness*, TED Talks, 2004

https://www.ted.com/talks/mihaly_csikszentmihalyi_on_flow 20 October 2016 11 [accessed 15 January 2017]

https://www.ted.com/talks/mihaly_csikszentmihalyi_on_flow. [accessed 10 July 2017]

⁶⁷ Slingerland, p. 8

⁶⁸ Many people I have spoken to in Korea and China describe Westerners as individualistic and therefore selfish. They describe themselves, on the other hand, as community oriented. This East/West distinction was even being taught at university level while I was a student at Hong-ik University in the late 1990s.

⁶⁹ Attributed to ancient Chinese Taoist philosopher Laozi, c. sixth century BCE, reputed author of the *Tao Te Ching*, which can be translated as *The Book of the Way of Virtue*.

to enter wúwéi, the less likely one is to be able to do so, making it impossible to fake virtue (dé). This raises the question of how true to shibusu's 'spontaneity of action' (true spontaneity) gestural ink-like glass inclusions are. I believe that they must be described in terms of 'spontaneity of effect' (apparent spontaneity) because they only mimic spontaneity of action, and the work of someone who is in wúwéi and exhibiting dé.

In addition to considering appropriate dictionary definitions of spontaneity, I therefore also evaluate inclusions in terms of their *likeness* (spontaneity of effect/apparent spontaneity) to brush and ink painting that has been executed by an artist in the Zone or in a state of wúwéi.

4. Summary

Defining casting is necessary to establish the technical scope of the project, yet my research shows that there is no comprehensive definition of cast glass, the glass-casting process or moulds – some of the most commonly-used glassmaking terms.

A cast *object* cannot be defined by its weight or density. Nor can the casting *process* be defined in terms of temperature. It is agreed within the glassmaking community, though, that casting, at the very least, requires a mould. Yet this, too, has no agreed or exhaustive definition.

I therefore formulate my own working definition: a mould is a hollow form, rather than a tool or an action, which completely contains molten glass, allowing it nowhere else to go. Defining a mould, by extension, defines casting as the term appears in the title of the project.

In this project, I use multiple processes to create each piece and therefore impose a supplementary rule for the purposes of this project: casting, as I have defined it, must be the last hot process in the series, for the piece to be considered cast.

I then address aesthetic considerations.

First, I assemble elements of otherwise inadequate spontaneity definitions to devise my own. 'Spontaneous' inclusions must exhibit an open, natural and uninhibited aesthetic, without *apparent* external cause and without being tended or cultivated. They must, therefore, *appear* to have arisen of their own accord.

I then review theories and philosophies that apply to the expressive arts including Csikszentmihályi's theory of flow (the Zone), and the Daoist philosophy of wúwéi. Both posit that spontaneity arises when an artist is so absorbed in their craft that the work feels effortless. This level of spontaneity translates directly into the nuances of their work.

Finally, I discuss the Japanese philosophy of shibusa that distinguishes between spontaneity of action (which I view as true spontaneity) and spontaneity of effect, or apparent spontaneity. Glassblowing represents spontaneity of action because the maker's movement transfers immediately to the glass. Inclusions in cast glass, on the other hand, represent spontaneity of effect because they do not benefit from immediacy in the glassmaking process, and only appear spontaneous.

III INK

A few drops of ink, a sheet of paper as a material for the accumulation and coordination of moments and acts, are all that is required. Paul Valéry⁷⁰

1. Introduction

This chapter contextualises the project within traditional Chinese painting and contemporary responses to it.

I begin by presenting a selection of artists who have explored new methods and materials for interpreting traditional Chinese calligraphy and landscape painting.⁷¹

The chapter describes the painting styles that inspired those artists and, more particularly, the characteristics of Grass script calligraphy and traditional landscape painting that underpin the aesthetic aims of this research.

The qualities that characterise line and wash in Chinese calligraphy and landscape painting begin with the materials used to create them – the Four Treasures of the Study – paper, brush, ink stick and ink stone.

In some pieces, I incorporate the colours used in traditional landscapes, including Daoist and Zen concepts of leaving blank space, the sparing use of colour and the vermilion ‘chop’.

The chapter concludes with an analysis of the third dimension in art and the problems that arise in the context of three-dimensional imagery embedded in a clear medium. For this reason, I develop a working definition of the third

⁷⁰ Paul Valéry, *Degas, Manet, Morisot*, ed. by Jackson Mathews, trans. by David Paul, Bollingen Series, XLV, 12 (Princeton, NJ: Princeton University Press, 1989), p. 67

⁷¹ Artists exploring these themes in glass are discussed in the next chapter.

dimension to describe the 'ink' inclusions in my work. I then use this definition to illustrate whether Chinese landscape and calligraphy works, interpreted in the third dimension, are in fact so. This approach contextualises the evaluation of the inclusions in my work and that of other glassmakers.

2. Reinterpreting Traditional Chinese Painting

Chinese painters have drastically reinterpreted traditional landscapes since at least the mid-twentieth century, beginning with Hong Kong painter Lui Shou Kwan 呂壽琨.⁷² According to Tang Hoichiu, Kwan was the founder of the Chinese New Ink Painting movement.⁷³ He was highly knowledgeable about the history of Chinese landscape painting, yet used traditional media – brush and ink on paper or silk – to challenge millennia of aesthetic tradition [Figure 12].



Figure 12 *Abstract Landscape*, 1962, Lui Shou Kwan, father of the New Ink Movement, brush and ink on paper, challenging traditional landscape painting aesthetics, 45x46cm. Source: alisan.com.hk/en/artists

Contemporary artists have followed in Kwan's footsteps, breaking with aesthetic tradition. In addition, they are using new media to address personal and social concerns.

⁷² Although Hong Kong was a British colony during his lifetime, Lui Shou Kwan (pinyin: Lǚ Shòukūn) (1919–1975) is considered to be a renowned Chinese painter.

⁷³ Tang Hoichiu, and Daphne King, 'Philosophical Quests and Artistic Propagation: Lui Shou-kwan as Father of New Ink Movement', in *A Legacy of Ink: Lui Shou-Kwan: 40 Years on* (Hong Kong: Alisan Fine Arts, 2015), Exhibition Catalogue



Figure 13 *Beautiful Dream 4*, 2008, Duan Jianyu, ink on cardboard, challenging traditional landscape painting in new media, 51x60cm. Collection: M+ Museum of Visual Culture, Hong Kong, © Duan Jianyu

In *Beautiful Dream 4* [Figure 13], for instance, Duan Jianyu 段建宇 uses ink on cardboard. In Sally Whitman Coleman's opinion, Duan's work addresses the status of 'high art' in contemporary China as well as the deterioration and 'packaged' commodification of traditional Chinese culture.⁷⁴ Beyond symbolism, the work also 'celebrates the cardboard's well-worn materiality', with the corrugation simulating rippling water and 'animating a clichéd representation' of Guilin's karst mountains⁷⁵ and their reflections in the Li river.⁷⁶

Zhang Huan 张洵 uses his own body as his ground in a performance piece that addresses identity in a highly personal photographic self-portrait series [Figure 14]. As Maxwell Hearn explains, Zhang had recently moved from China to the United States and, with only rudimentary command of the English language, felt the need to define his identity, through his art.⁷⁷ For his performance piece, *Family Tree*, for example, three people painted brush and ink calligraphy on Zhan's face, continuing to write significant or

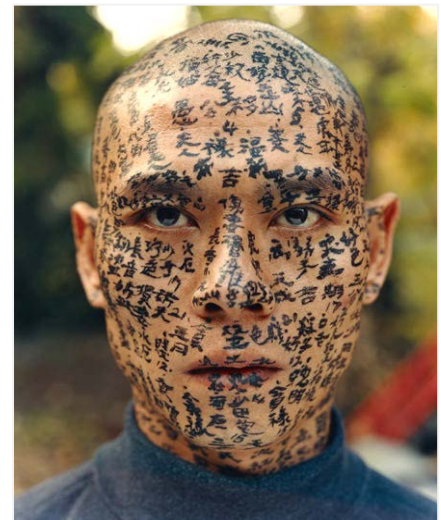

Figure 14 *Family Tree (Detail)*, 2000, Zhang Huan, performance and photography, calligraphy reinterpreted in non-traditional body painting. Source: zhanghuan.com

⁷⁴ Sally Whitman Coleman, 'Make the Time: Contemporary Chinese Art at the Metropolitan Museum of Art', *Chinese Art, Metropolitan Museum of Art*, 2014 <http://www.the-art-minute.com/make-the-time-contemporary-chinese-art-at-the-metropolitan-museum-of-art/> [accessed 30 August 2016]

⁷⁵ See Chapter IV – Glass > Artist Survey: Technical and Aesthetic Context > Aesthetic Context: Casting – Ink, Landscape and Calligraphy

⁷⁶ Wang Xin, 'What Beautiful Dreams Are Made Of', *Asian Art, The Metropolitan Museum of Art*, 2014 <http://metmuseum.org/blogs/now-at-the-met/2014/beautiful-dreams> [accessed 30 August 2016]

⁷⁷ Maxwell K. Hearn, Wu Hung, and Metropolitan Museum of Art (New York, N.Y.), eds., *Ink Art: Past as Present in Contemporary China* (New York: The Metropolitan Museum of Art, 2013), p. 66

political names and fables until Zhang's face had turned completely black. At that point, he says, 'my identity had disappeared. My face turned black. My appearance disappeared as well. Nobody knew the colour of my skin, and it was as if my identification no longer existed. I disappeared'.⁷⁸

Xu Bing 徐冰 uses installation to explore pseudo-calligraphy and communication in *Book from the Sky* (天书 *Tiānshū*) [Figure 15]. For this provocative work, Xu created and printed some 4,000 faux, yet realistic-looking Chinese characters that incorporate brush stroke components of a Ming Dynasty font.⁷⁹

Xu's asemic writing creates cross-cultural, 'induced illiteracy',⁸⁰ requiring audiences to have, according to Leslie Ross, a 'willingly appreciative lack of comprehension'.⁸¹ Evidence shows, though, that the opposite is true. According to Jerome Silbergeld, Chinese readers have been 'surprised, often dismayed and sometimes angry to discover that the words could not be read'.



Figure 15 *Book from the Sky*, 1987–1991, Xu Bing, mixed media installation/hand-printed books and scrolls, printed from blocks inscribed with faux Chinese characters. Installation at Taipei Fine Arts Museum, 2014. ©Xu Bing Studio.

⁷⁸ Ibid., p. 70

⁷⁹ Rather than painting his invented characters, Xu used moveable type wood blocks that he carved personally, reviving the skills used when the Chinese invented the wooden moveable type printing press, c. 1297, several centuries before Gutenberg invented his in 1450 – there being no evidence of a link between the two. (The Chinese had also invented the world's earliest fixed-type printing press c. 593. See: Michael Twyman, *The British Library Guide to Printing: History and Techniques*, British Library Guides (Toronto: University of Toronto Press, Scholarly Publishing Division, 1999), pp. 20–21

⁸⁰ Jerome Silbergeld, 'Book from the Sky: A Work by Xu Bing', *Princeton University Art Museum*, 2003
<https://etcweb.princeton.edu/asianart/assets/archivedmaterials/Xu%20Bing%20handout.pdf> [accessed 30 August 2016]

⁸¹ Leslie Ross, *Language in the Visual Arts: The Interplay of Text and Imagery* (Jefferson, NC: McFarland & Company, Inc., Publishers, 2014), p. 181

Many readers of Chinese even consider the work an ‘abuse of language’.⁸²



Figure 16 *Viewing the City's Places of Interest in Springtime*, 2007, Yao Lu 姚璐, Chromogenic print, landscape reinterpretation in new media, 80x80cm. Source: uk.phaidon.com

Yao Lu's 姚璐 work addresses the destructive effects of urbanisation on the majesty of nature, represented for millennia in Chinese landscape painting [Figure 16].

In a further break from traditional media, Lu photographed mundane scenes, such as mounds of garbage covered in green netting used to keep rubbish from becoming airborne. He then digitally assembled and manipulated the images to create works that resemble traditional Chinese mountainscapes, shrouded in mist.

Finally, video makers are bringing traditional ink painting even further into the digital era, through animation.

A Hamburg company, WeareFLINK, for example, created a multi-award-winning 2010 promotional video for CCTV, China's main television network. For aesthetic reference, the designers injected Chinese ink into a water tank [Figure 17]⁸³



Figure 17 *CCTV 'Ink' Making-of*, 2009-2010, WeareFLINK, video (still, 5:13), research into ink movement in water. Source: vimeo.com/20410575

⁸² Silbergeld (2003). A comprehensive discussion of language and communication is outside the scope of this research but this fascinating field is becoming increasingly relevant in today's globalised art world.

⁸³ WeareFLINK, *CCTV 'Ink' Making-of*, 2010 <vimeo.com/20410575> [accessed 14 September 2015]

and observed its spontaneous, dynamic and unfettered movement, allowing them to digitally animate traditional ink wash painting [Figure 18].⁸⁴



Figure 18 *Ink (Directors Cut)*, 2010, WeareFLINK, award-winning landscape animation video (still, 0:09), for CCTV, Beijing. Source: vimeo.com/20409478

Others are developing computer programmes that simulate Chinese brush and ink calligraphy.

Chu Siu-Hang, for instance, focuses on recreating the sensitivities of ink painting on paper, such as ink dispersion in wet and drybrush and ‘split-tuft’ techniques.⁸⁵ His revolutionary software replicates these and other vital aspects of Chinese calligraphy by allowing the user to alter brush pressure, using a stylus and tablet to create realistic, rhythmic and gestural calligraphic strokes.⁸⁶

⁸⁴ WeareFLINK, and Niko Tziopoulos, ‘Ink’ (Directors Cut), 2009 <<http://vimeo.com/20409478>> [accessed 15 September 2015]
For a comparison to earlier analogue landscape animation, see Te Wei, *Feeling from Mountain and Water* (Shanghai: Shanghai Animation Film Studio, 1988) <https://www.youtube.com/watch?v=mE5F78_PUTM> [accessed 2 December 2016]

⁸⁵ Chu Siu Hang, ‘Making Digital Painting Organic’ (PhD Thesis, The Hong Kong University of Science and Technology, 2007), p. 15

⁸⁶ *Ibid.*

3. The Four Treasures of the Study

The qualities that characterise line and wash in traditional Chinese painting, and are key to this research, begin with the materials used to create them: the Four Treasures of the Study.⁸⁷ Each of these plays a critical role in the aesthetics of landscape painting and calligraphy.

a) *Brush*

The traditional Chinese brush is made from a variety of animal hair,⁸⁸ from soft to coarse, in varying combinations and lengths. Synthetic hair is not used.

Brushes can even be made of human hair, in which the hair from a baby's first haircut is used in the belief that the brush will inspire and bring good fortune to the child as they grow up. This practice illustrates the cultural importance of the brush and, by extension, brush and ink painting in China. Although baby-hair brushes are considered mementos today, they are known to have actually been used in painting as far back as 1,400 years ago.⁸⁹

Chinese brushes have a long, thick body (with a pointed tip) and can hold more liquid than similarly-sized brushes used in other painting traditions, with the largest useable brush ever made [Figure 19] able to



Figure 19 He Wenjun (2009) painting calligraphy with his (then) largest brush ever made. Source <http://metro.co.uk/2009/09/23/brush-with-greatness-the-world-record-breaking-paintbrush-439954/>

⁸⁷ Ouyang Zhongshi, and Fong Wen C., eds., *Chinese Calligraphy (Culture & Civilization of China)*, trans. by Uta Lauer and others (New Haven ; Beijing: Yale University Press, 2008), p. 45

⁸⁸ Including that of Siberian Weasels (known as Yellow-Rat-Wolves), pigs, mice, buffalo, wolves and rabbits, while exotic ones can be made from tiger, fowl and deer.

⁸⁹ Chen Tingyou, *Chinese Calligraphy*, Introductions to Chinese Culture, Updated ed (Cambridge: Cambridge University Press, 2011), pp. 39–40

soak up to 45 kilograms of liquid ink.⁹⁰

A traditional Chinese brush therefore allows for long, continuous strokes [Figure 20] that can be dark, light, thick, thin, tapering or turning, all within the same stroke, an important feature of Grass script calligraphy, described below. The same versatile brush can also execute washes that display a full range of tones, texture, dotting, dry scrubbing and wet applications.



Figure 20 *One Stroke Snake Painting for 2013, 2013*, (video still, 2:17), using a single Chinese brush to demonstrate a range of wash and line in one stroke. Source: <https://www.youtube.com/watch?v=dKJkBFEWc3g>

The lines created with a Chinese brush are organic. They are never hard or uniformly straight [Figure 21, left].⁹¹ Nor do they produce sharp corners as is possible with a metal-tipped pen, used in Western calligraphy [Figure 21, top



Figure 21 Organic straight lines using Chinese brush and ink (left), straight, even lines using broad-topped metal pen and ink (top right) and reed-nib and ink (bottom right)

⁹⁰ Ibid. See also: Mike Wing, *Chinese Calligraphy Demonstration: Master Guoliang Huang*, 2010 <https://www.youtube.com/watch?v=INQ6dh4yda8> [accessed 11 March 2017]

⁹¹ Sharp angles may appear where lines intersect but the lines themselves do not turn on sharp angles. The Chinese calligraphy in Figure 21 is a detail from 'Excerpt from the Duobao Pagoda Stele in standard script', Qing Dynasty, Qian Feng (1740–1795), ink on paper, 84x42cm hanging scroll. Collection: Freer Gallery of Art and Arthur M. Sackler Gallery, Smithsonian Institution, Washington, D.C.: Gift of Robert Hatfield Ellsworth in honour of the 75th Anniversary of the Freer Gallery of Art, F1998.83

right], or a reed nib in Islamic calligraphy [Figure 21, bottom right].⁹² This organicity contributes to the spontaneity this research seeks to emulate in cast glass inclusions.

b) *Paper*

Paper, I understand, was invented by the Chinese; Western paper is to us no more than something to be used, while the texture of Chinese paper [...] gives us a certain feeling of warmth, of calm and of repose. Western paper turns away the light, while [Chinese] paper seems to take it in, to envelop it gently, like the soft surface of first snowfall. It gives off no sound when it is crumpled or folded, it is quiet and pliant to the touch as the leaf of a tree. Junichiro Tanizaki⁹³

Rice-based *xuān* paper (xuānzhǐ 宣紙), also plays a critical role in Chinese ink painting.⁹⁴ It is soft and has very little tooth, compared to most watercolour paper. It is also extremely fine – about half the thickness of newsprint and about 25 grams per square meter.⁹⁵ Despite its apparent fragility, it is stretched and mounted wet, without falling apart. In addition, its archival quality gives *xuān* paper a reputation for lasting ‘1,000 years’.⁹⁶

Most importantly for this research, it is highly absorbent, allowing for quick, spontaneous strokes to set immediately and not bleed. Its thinness also allows

⁹² As central as calligraphy has been to Chinese culture and art, the many styles of Islamic calligraphy also have a long and important history of ‘expressing Islamic culture and civilization’. Alkandari, Fahad, ‘Islamic Ceramic Ornamentation and Process: Proposals for a New Aesthetic Vocabulary in Contemporary Architectural Embellishment within Kuwait’ (PhD Thesis, University of Central Lancashire, 2011) p. XXIII

⁹³ Junichiro Tanizaki, *In Praise of Shadows*, trans. by Thomas J. Harper and Edward G. Seidensticker (Sedgwick: Leete’s Island Books, 1977), pp. 9–10

⁹⁴ *Xuān* paper can also be made from mulberry, grass straw and hemp but is still referred to as rice (or *xuān*) paper.

⁹⁵ Even the lowest student-quality watercolour paper is about 300 grams per square metre.

⁹⁶ ‘Chinese Rice Paper / Xuan Zhi / Xuan Paper’, *InkDance Chinese Painting Gallery*, nd, <http://www.inkdancechinesepaintings.com/knowledge/chinese-rice-paper.html> [accessed 5 November 2015]

ink to seep through to the other side. This creates a softer, less-saturated painting on an underlying page, which is sometimes considered more valuable than the original.⁹⁷ I therefore regard faint or slightly blurry lines as positive attributes when evaluating 'ink' inclusions in glass.

c) *Ink Stick and Ink Stone*

A stick of compressed pine soot is ground on a satin-finished stone [Figure 22], with a little water, to create an opaque, permanent ink that has a slight sheen.⁹⁸ Ink grinding allows the artist to retain control over its quality and density. Inferior, commercially-available liquid inks are only used for practising.⁹⁹



Figure 22 Tung oil soot ink stick and lidded ink stone, used for grinding liquid ink. Source: Blue Heron Arts

Although well-prepared ink is crucial to the overall quality of a painting, its subtlety makes it less

⁹⁷ Jin Dian Shan interview with Sheila Labatt re: The Five Colours of Black (墨分五色), Shanghai, 13 April 2013.

⁹⁸ In contrast, watercolour is transparent, matte, and usually uses plant-based gum arabic as a binder. The Chinese ink's sheen is due to its density and composition: soot, as a permanent pigment, and animal glue, which prevents the ink from bleeding when the wet xuān paper is stretched and mounted. Watercolour paper must be stretched prior to painting. The soot in Chinese ink also affects its colour – blue-black, brown-black and a true black – depending on the part of the pine tree that was used to create the soot. Xue (Shelly) Lü interview with Sheila Labatt re: Colours of Ink (水墨 shuǐmò), London, 18 June, 2017. A more complete discussion of the chemistry of inks, dyes and watercolour paints is outside the scope of this research.

⁹⁹ Some Western painters still grind their own colour, as part of the 'magic of creativity' and because it is usually cheaper to do so. Like ink grinding, it allows for complete control over colour and consistency. It is messy, though, and many pigments are toxic, unlike soot. Grinding one's own colour is therefore more complicated than grinding ink, which is one of the reasons that traditional Chinese ink grinding has remained more common than colour grinding for Western paints. Francois Delamare and Bernard Guineau, *2000 Colors: The Story of Dyes and Pigments* (New York: Harry N. Abrams, 2000) and Jonathan Janson, 'Hand Grinding and the Purchase of Materials', *Essential Vermeer* <http://www.essentialvermeer.com/palette/palette_grinding_and_materials.html#.WHOVsLGcYdV> [accessed 12 December 2016]

important in the context of this research, since less nuanced painting characteristics are used to evaluate the work

What is important though, in the context of spontaneity, is that all serious artists grind their own ink because the slow, repetitive, circular process forms an intimate part of their preparation for painting: to induce a sense of serenity and, ultimately, a state of wúwéi.¹⁰⁰

4. Line

a) *Gesture in Brush and Ink Painting*

Accomplished Chinese brush and ink painting begins with the artist's state of heart/mind (心 *xīn*) that results in a *gesture*, beginning at the shoulder and traveling down through to the hand and brush, to the page. Traces of the painter's spirit and vitality are thus made visible and the ink becomes a metaphor for personal flow.¹⁰¹

The idea of gesture in the context of this research can be summarised in two pen and ink line drawings by Saul Steinberg: The stiff, seated, nearly inactive figure in *The Line* [Figure 23]¹⁰² is drawing a uniformly weighted, highly controlled, straight, objective, non-gestural line in which the activity is restricted to the hand. This line quality is never seen in Chinese calligraphy.

¹⁰⁰ Naomi Okamoto, *The Art of Sumi-E: Beautiful Ink Painting Using Japanese Brushwork* (Search Press, 2015), p. 16. For a demonstration of ink grinding, see Henry Li, *How to Make Sumi Ink from Inkstick and Inkstone*, Blue Heron Arts, 2009 <<https://www.youtube.com/watch?v=CeeCCf-F8os>> [accessed 17 November 2016]

¹⁰¹ Denis Brown, 'Ink 2008: For All Writers', *Quill Skill*, 2008 http://www.quillskill.com/frameset/frameset_movies.html [accessed 27 August 2017]

¹⁰² Saul Steinberg, *Drawings for the Children's Labyrinth* (detail), 1954, 10th Milan Triennial, ink on paper folded into 29 sections, 46x1026cm (Nieves; Box edition, 2014). Collection: Saul Steinberg Foundation

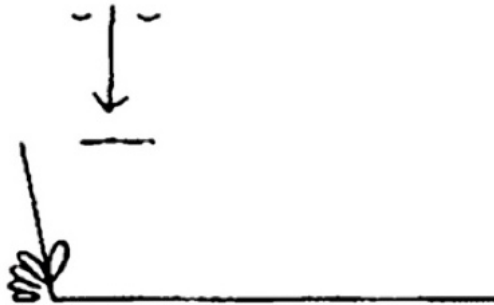

Figure 23 *The Line* (detail), 1954, Saul Steinberg, ink on paper, drawing without gesture. Collection: The Saul Steinberg Foundation

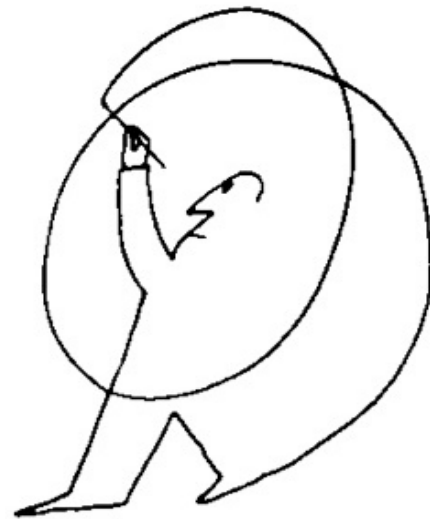

Figure 24 Untitled, 1948, Saul Steinberg, ink on paper, focused yet gestural drawing style, emanating from the shoulder, 36x29cm. Collection: Saul Steinberg Papers, Beinecke Rare Book and Manuscript Library

The untitled drawing [Figure 24],¹⁰³ on the other hand, shows a standing figure drawing a spontaneous, relaxed and expressive line and demonstrates a freedom of movement not seen in *The Line*. In Chinese calligraphy, as in this image, the painter usually stands to execute lines that emanate from their shoulder.

b) *Chinese Calligraphy*

(i) *Introduction*

In China, one begins with calligraphy practice (at school) before moving on to landscapes, making calligraphy skills the basis for all brush and ink painting.

Not only is calligraphy considered the highest art form in ancient China, it is also an important communication tool. Many dialects of Chinese are as mutually

¹⁰³ Saul Steinberg, Untitled, 1948, Beinecke Rare Book and Manuscript Library, Yale University <http://www.saulsteinbergfoundation.org/contact.html> [accessed 5 April 2013]. Reproduced in Deirdre Blair, *Saul Steinberg: A Biography* (New York: Nan A. Talese/Doubleday & Co Inc., 2012)

unintelligible as, say, English is to Polish.¹⁰⁴ For reading and writing, however, all dialects share the same characters (with the same meaning but, often, different pronunciations).¹⁰⁵ In ancient times, this unique feature of written Chinese allowed educated people to communicate across dialects by drawing characters, sometimes even with a stick on the ground in front of them.¹⁰⁶ In this project, only the *characteristics* of calligraphic lines are relevant. As abstractions of calligraphy, therefore, the lines in the finished pieces do not replicate characters. Instead, they *evoke* calligraphy, language or any other idiosyncratic references but do not bear formal semantic suggestion.

Cy Twombly used a similar approach in his *Bacchus* series. These large-scale, spontaneous, confident and energetic lines were inspired by Chinese calligraphy and, as Edmund White explains, ‘liberate’ the words (Bacchus,

¹⁰⁴ Scholars cannot agree on how many dialects exist in China. By some measures, there are seven and by others, at least 200. The official dialect is the Beijing form of Mandarin (普通话 pǔtōnghuà, lit. ordinary speech). It is therefore the dialect of instruction in schools. People who speak Mandarin and their own dialect are considered bilingual.

¹⁰⁵ One exception is *nú shū* (奴书, lit. women’s book), an ancient phonetic script secretly devised and used by the (forcibly) uneducated women of the matriarchal Moso tribe, in a remote area of Hunan Province. See: Orié Endō, ‘Endangered System of Women’s Writing from Hunan, China’, *World of Nushu*, nd <http://nushu.world.coocan.jp/home> [accessed 3 July 2016]. In the contemporary context, ‘phonocentrically-obsessed’ youth celebrate their identity by developing internet languages for which they devise new characters that reflect the sounds of their own dialect (方言文字话 fāngyán wénzì huà, lit. dialect text words). See Liu Jin, ‘Deviant Writing and Youth Identity: Representation of Dialects with Chinese Characters on the Internet’, *Chinese Language and Discourse*, 2 (2011), pp. 58–79

¹⁰⁶ Recognisable Chinese characters, dating back some 4,000 years, comprise the oldest, continuously used writing system in the world. They are the basis for all Northeast Asian calligraphy and are still used in Korea and Japan, alongside their own alphabets/syllabaries. These were developed millennia after they had adopted Chinese characters: Hangul 한글 in Korea (invented in 1446 AD) and, in Japan, Hiragana ひらがな (adapted from Chinese characters, fifth century AD, and originally used by women) and Katakana カタカナ (adapted from Chinese characters, ninth century AD, and originally reserved for men). An extensive bibliography on the history of East Asian writing systems can be found at David Lurie ‘History of East Asian Writing Systems’, 2004 <http://www.columbia.edu/~dbl11/Lurie.EAwriting04x.pdf> [accessed 1 July 2016]

Psilax and Mainomenos) from their 'semantic baggage', retaining pure 'gesture and movement' [Figure 25].¹⁰⁷



Figure 25 Untitled, 2005, Cy Twombly, acrylic on canvas, liberating semantics in gestural painting, 318x469cm. © Cy Twombly Foundation



Figure 26 *Sumi II*, 1957, Mark Tobey, Chinese calligraphy-inspired, ink on paper, 33x 24cm. Source seattleartresource.com/mystic-modernism

Likewise, abstract expressionist Mark Tobey's ink paintings [Figure 26] were inspired by Chinese calligraphy, which he learned from a Chinese artist.¹⁰⁸ His abstractions also demonstrate the spontaneity, balance and vitality of Chinese brush work, without reference to ordinary semantics. He therefore gives viewers a 'sense of the calligraphic art forms that inspired [him]', as is the intent in this project's glass inclusions.¹⁰⁹

The lines that are important to this research are those of Grass script calligraphy, a gestural, highly personal abstraction of the basic Chinese Standard script. In the following sections, I describe Standard script as a way to contextualise the characteristics of Grass script, by contrasting the two.

¹⁰⁷ Edmund White, 'Cy Twombly: Late Paintings 2003–2011, by Nela Pavlouskova', *Sunday Book Review, The New York Times*, 2015 https://www.nytimes.com/2015/06/28/books/review/cy-twombly-late-paintings-2003-2011-by-nela-pavlouskova.html?mcubz=0&_r=0 [accessed 30 September 2016]

¹⁰⁸ Virginia M. Mecklenburg, *American Realism: The Sara Roby Foundation Collection* (Washington, DC: Smithsonian Institution Press, 1987), Exhibition Catalogue

¹⁰⁹ Ross, p. 182

As a starting point, Figure 27 illustrates the progressive abstraction of Standard script (left) and shows that Grass script (right) sits at the furthest end of the sequence. The character 永 (yǒng), meaning eternity, is used to compare and contrast six scripts and is often used when practising Standard script because it comprises (a version of) each of the eight basic strokes, all within the same character:¹¹⁰



Figure 27 The character for 'eternity', 永 (yǒng), in six calligraphic styles, showing progressive abstraction from Standard script (left) to Grass script (right)

(ii) *Standard Script (楷書 kǎishū)*

Standard script – also known as regular script – was one of the last calligraphy styles to develop¹¹¹ and is the first one taught to school children and to beginners, such as myself. It is also the most easily recognised and legible Chinese script and is the basis for all cursive styles (including Grass script), as well as printing fonts.

As can be seen in Figure 27 and Figure 28, Standard script characters are well defined and controlled. Although their strokes are never loose or expressionistic, neither do they appear rigid.

¹¹⁰ Each stroke also has its own name. Scholarly opinions vary, though, as to the number of basic strokes but eight, minus any variations, is the generally-accepted number. Note that these examples are computer-generated and somewhat 'devoid of spirit'. Source: Manny Ling, 'Calligraphy Across Boundaries' (PhD, University of Sunderland, 2008), p. 94

¹¹¹ Standard script was first practised at the end of the Han Dynasty, around 220 AD, and matured during the Tang Dynasty (618–907 AD).

The strokes are also individually named, predictable (hence the name Standard) and have neither sharp corners nor abrupt ends. They either taper gradually or comprise ‘silkworm heads’ and ‘goose tail ends’, as can be seen in the *héng* (橫) stroke in the upper left corner of Figure 28.

The lines can be straight but are never rigidly so and, although they have corners and turns, these are never sharp, as they can be in pen and ink Gothic style calligraphy, for example [Figure 29].

Most importantly, they are written slowly, with precision and control. Standard script strokes must also reflect a confidence and ease of execution that comes with years of

practice and is important in all good brush and ink painting, including Grass script calligraphy and landscape painting.

Not only are the strokes’ shapes strictly prescribed, so too is their composition within a character. The strokes are written separately and with confidence, according to the rules of stroke order – generally left to right and top to bottom, with certain exceptions.¹¹²

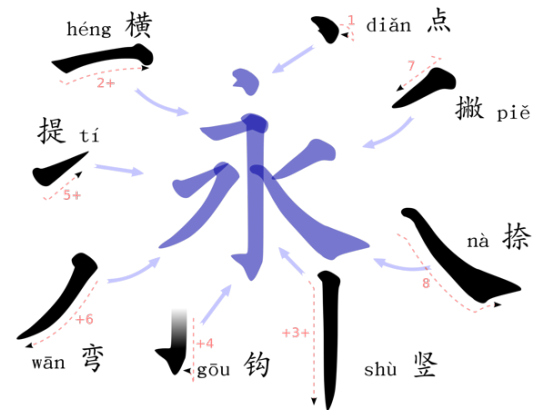

Figure 28 The eight basic strokes of Standard script and the character 永 (yǒng/eternity), showing gently-tapering lines and ‘silkworm heads’ and ‘goose tail ends’ in the *héng* stroke (upper left)



Figure 29 Pen and ink Gothic (or Blackletter) calligraphy style, showing straight, even lines and sharp angles

¹¹² Demonstration of 永 yǒng (eternity) executed in Standard script: 永 (Yong) ‘Forever’ or ‘Eternity’ in Chinese Calligraphy 書法 [Regular Script], Top Chinese Arts, 2012 <<http://topartchina.com/top-chinese-calligraphy/永-yong-forever-or-eternity-in-chinese-calligraphy-書法>> [accessed 15 September 2015]

Thus, well-written strokes combine to form properly-proportioned and visually-balanced characters, each of which (usually) represents one morpheme and meaning.¹¹³ Each character must also be centred within a notional square grid (which is often printed on low-quality practice paper [Figure 30]). Finally, multiple well-balanced, properly-proportioned characters, comprising perfectly-executed strokes, must occupy a balanced position within the overall composition.

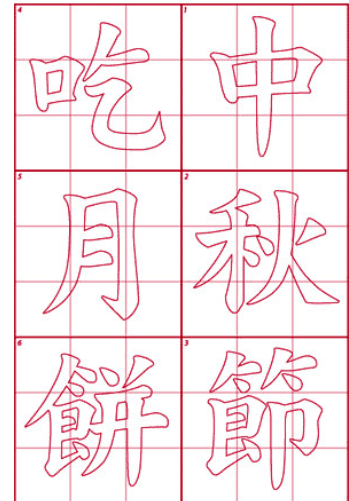

Figure 30 Practice paper showing square grids, with six properly-balanced Standard script characters to copy. © 2001-2013 Good Characters, Inc.

Standard script therefore requires excellent brush control and takes years of practice to master, particularly since nothing in a sometimes very long piece can be erased, rewritten or painted over. Only then is it considered appropriate for a painter to practise Grass script.¹¹⁴

(iii) Grass Script (草书 cǎoshū)

Grass script is considered the most advanced and elegant of the scripts, requiring many years of practice, following mastery of Standard script.¹¹⁵ It is a highly abstract and animated response to Standard script and is written more quickly than any of the other scripts. This speed of execution creates the spontaneity and immediacy that characterise the script and are of importance in this project. Tang (T'ang) Dynasty monk, Huai Su's 'wild' Grass

¹¹³ This is distinct from Western scripts, in which individual letters (other than 'a' or 'i', in English, for example) do not have their own meaning but signify sounds that make up words.

¹¹⁴ This idea has a parallel in drawing, for example, where it is often said that one must first be able to draw accurately, from sight, before abstraction is appropriate.

¹¹⁵ Demonstration of 永 yǒng (eternity) executed in Grass script: 永 (Yong) 'Forever' or 'Eternity' in Cursive [Grass Script] Calligraphy, Top Chinese Arts, 2008 <www.youtube.com/watch?v=mZobMS08LY0> [accessed 15 September 2015]

script (狂草 kuángcǎo, lit. mad grass), for instance, was highly praised and described as being as 'swift as a galloping stallion' [Figure 31].¹¹⁶

In addition to his political notariety, Chairman Mao Zedong (Mao Tse-tung), also a poet and talented calligrapher, was known for his quick brush strokes, too, and his particularly unorthodox and unrestrained wild cursive Grass script [Figure 32].

Unlike Standard script, where uniformity is paramount, Grass script has no prescribed rules, meaning that each artist has their own, unique style. Comparing Mao's style to Huai Su's [Figure 31] demonstrates exactly how personal Grass script is. All good examples of the script, though, exhibit fluidity, gesture and rhythm.

In Grass script, the brush is hardly lifted from the page, creating long, spontaneous lines that can be likened to an extreme abstraction of cursive script in the Latin alphabet [Figure 33]. Grass script is also sometimes

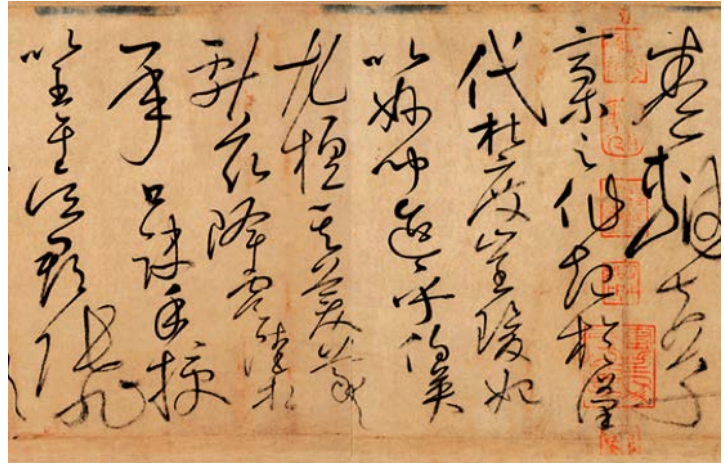

Figure 31 Autobiography (detail), 777AD, Huai Su, ink on paper, 28x755cm handscroll, his brush was 'as swift as a galloping stallion'. Collection: National Palace Museum, Taipei (故-書-000062-00000)



Figure 32 縛 (fù, to bind), character from Mao Zedong's poem 'Mount Liupan' (1935), in his own wild cursive Grass script calligraphy (1961). Source: Chinese Calligraphy, Ouyang Zhongshi et al.

¹¹⁶ Huai Su's 'wild' style was allegedly a function of his drunkenness while painting. Still, his *Autobiography* handscroll is considered one of the best examples of Grass script in Chinese history. Sources: Vincent Poon, 'Huai Su's Autobiography: Modelling (Shu Version), History, English Translation and A Preliminary Study', *Vincent's Calligraphy*, 2017 <<http://www.vincentpoon.com/autobiography-of-huai-su.html>> [accessed 10 August 2017] and David Hinton, ed., *Classical Chinese Poetry: An Anthology*, trans. by David Hinton, Paperback (New York, NY: Farrar, Straus and Giroux, 2010), p. 172

referred to as cursive script.¹¹⁷

This degree of abstraction can be seen, for example, when comparing the word for chrysanthemum (菊花 júhuā) in Standard and Grass scripts. In Standard script, the two characters comprise 20 distinct strokes [Figure 34], whereas both characters are rendered in a single, continuous stroke in Grass script [Figure 35].¹¹⁸

Figure 35 is also a good example of the most recognised characteristics of Grass script lines: continuous and rounded, displaying a balance of weight, speed, rhythm and ink quality. The artist also varies the pressure (known as 'push and release'), turning the brush as the line progresses, with attention to balancing energy, inertia and weight.

Unlike Standard script, Grass script is executed with a vigorous immediacy that reflects the calligrapher's state of heart/mind (心 xīn) and spirit.

The brush strokes are therefore lively, spontaneous, and unpredictable, giving the writing a sense of flow and ordered chaos.



Figure 33 Extreme abstraction of cursive Latin script, representing the extent to which Grass script is abstracted from Standard script. Illustration: Sheila Labatt



Figure 34 Chrysanthemum (菊花 júhuā) in Standard script, two characters in 20 strokes



Figure 35 *Poem by Cui Shu* (detail), Ming Dynasty, early to mid-16th century, Wen Peng, ink on paper, chrysanthemum (菊花 júhuā) in Grass script, two characters in a single stroke also demonstrating the 'flying white' technique, 84x42cm hanging scroll. Collection: Freer Gallery of Art, (F1980.10)

¹¹⁷ The nomenclature is used inconsistently. Most people consider cursive script to be a distinct script that is slightly easier to read than Grass script. Others use the script names interchangeably, probably because they exhibit similar gestural characteristics.

¹¹⁸ Image of *Poem by Cui Shu* (detail) courtesy of Freer Gallery of Art and Arthur M. Sackler Gallery, Smithsonian Institution, Washington, DC: Purchase – Regents' Collections Acquisition Program (F1980.10)

I believe that, although abstract expressionists only referred to their inspiration as Chinese calligraphy – in general, without reference to a particular script – they were most likely influenced by Grass script, whether they were aware of it or not.

One final characteristic of Grass script is that its long strokes and rapid execution sometimes result in delicate ‘flying white’ strokes (飞白 fēibái), in which the brush is allowed to dry slightly, causing the hairs to split [Figure 35]. Flying white strokes would be considered faulty (败笔 bàibǐ) in Standard script, in which the ink must remain fully saturated. In Grass script, though, they are a recognised brushwork technique – rather than a style or script (like Standard and Grass) – that produces raw, animated lines and accentuates the spontaneity of the painting process.

5. Wash

a) Introduction

Several Western painting genres use wash techniques, in which diluted colour is loosely deposited, as if the brush were ‘washing’ the paper or canvas.

Although this is particularly common in watercolour painting, other media have also been used. For instance, Helen Frankenthaler poured diluted paint directly onto raw canvas to create abstract expressionistic, ‘soak-stain’ colour field paintings [Figure 36].¹¹⁹ Her works display gently-merging, luminous washes



Figure 36 *Morpheus*, 1988, Helen Frankenthaler, diluted acrylic on unprimed canvas, showing flat, luminous, merging washes. 295x229cm. Source: Miles McEnery Gallery, 2014

¹¹⁹ Frankenthaler began by using oil paint diluted with turpentine but later switched to acrylic and water because the heavy application of turpentine had been causing her canvases to deteriorate. Source: Phillip Barcio, ‘The Revolution Abstract Acrylic Painting Brought to the Medium’, *Ideal Art: Online*

whose qualities nevertheless differ from Chinese ink washes, which are painted using unique tools: the Four Treasure of the Study, described above.

Ink wash is specifically linked to traditional Northeast Asian painting. In China, it is often associated with *literati painters* (文人 wén rén), who were highly educated bureaucrats – not academics – in Imperial China.¹²⁰ Many of them excelled at the highest traditional art forms: poetry, calligraphy and painting.¹²¹

The literati are also known for the reformation of rigid, formulaic landscape painting conventions by seeking spiritual expression through their largely monochromatic works [Figure 37].¹²² Masterful examples of this expressionism reflect a painter's psychological state, possibly wúwéi, and are an intangible quality to be emulated in the context of this project.

Galleries for Contemporary Abstract Art, nd

<<http://www.ideelart.com/module/csblog/post/292-1-abstract-acrylic-painting.html>> [accessed 31 March 2018]

¹²⁰ Beginning in the Northern Song Dynasty (960–1127)

¹²¹ 'Academic' or 'court' painters were professional artists who depended for their livelihood on permanent employment as painters or on selling their paintings. As such, their work was designed to please the ordinary citizen. Many court painters were somewhat educated but few possessed the literary or cultural background of a *literatus*, and none pursued the Confucian ideal of governmental service. *Literati* painters, on the other hand, were highly-educated, cultured amateurs who had passed civil service exams. They practiced the 'Three Perfections' in Chinese art – calligraphy, landscape painting and writing poetry – as a means of self-expression (rather than to appeal to the masses by painting formulaic, so called 'beautiful pictures', as the academic/court painters were doing). Although painting was never an aspect of the government exams, many *literati* either painted on the side, while playing the role of scholar-officials for the emperor, or had the wealth to devote themselves fully to their art. Source: Benjamin A. Elman, 'Civil Service Examinations (科 举 kējǔ)', *Berkshire Encyclopedia of China* (Great Barrington, MA; Berkshire: Berkshire Encyclopedia of China, 2000), pp. 405–410 <<https://www.princeton.edu/~elman/documents/Civil%20Service%20Examinations.pdf>> [accessed 10 January 2017]

¹²² China Online Museum, 'Literati Painting', nd

<<http://www.comuseum.com/painting/schools/literati-painting/>> [accessed 20 January 2017]



Figure 37 *Xiao and Xiang Rivers*, Five Dynasties (907–960AD), Dong Yuan, ink and colour on silk, early example of literati ink wash painting, shunning traditional concepts of beauty in landscape painting in favour of spiritual expression, 50x141cm handscroll. Collection: Palace Museum, Beijing

b) *Wash Qualities*

Black ink wash is commonly used in Chinese landscape painting and, when skilfully executed, can seemingly display many colours. This key characteristic of highly accomplished Chinese landscape painting is called *mò fēn wǔ sè* (墨分五色), which commonly translates as the ‘Five Colours of Black’ [Figure 38].^{123,124}

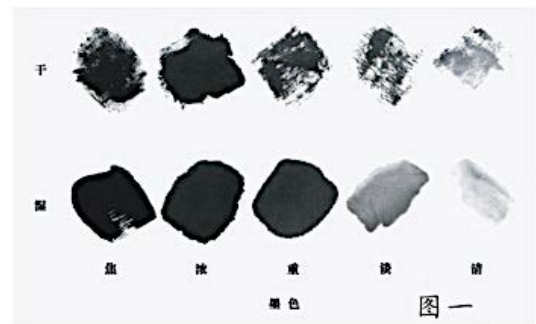

Figure 38 The Five Colours of Black in dry and wet brush techniques. Source: <https://sns.91ddcc.com/t/44307>

¹²³ *mò fēn wǔ sè* (墨分五色) – The ‘Five Colours of Black’, usually refers to the following colours: Dark Black (浓墨 *nóng*), Light Black (淡墨 *dàn*), Black (黑 *hēi*), Dry Black (干墨 *gān*) and Wet Black (湿墨 *shī*). Some, on the other hand, consider the five colours to be Soot Black (焦墨 *jiāo*), Dark Black (浓墨 *nóng*), Strong Black (重墨 *zhòng*), Light Black (淡墨 *dàn*) and Clear Black (轻墨 *qīng*). Regardless of the nomenclature, the intent is that rendering the broadest range of wash tonality is essential in accomplished landscape painting. University of Sunderland PhD candidate, Shi Dian 时典 (known as Dian Shi in the West) is investigating the ability of metal oxides to render calligraphy with *mò fēn wǔ sè* effects in glass. Project proposal: ‘An Investigation into Contemporary Chinese Glass Calligraphy through the Application of Metal Oxides in Studio Glass’, 2017.

¹²⁴ Although *mò fēn wǔ sè* (the Five Colours of Black) is associated with landscape painting, contemporary calligrapher Jin Dian Shan contends that this aesthetic should also be considered in the context of Grass script calligraphy since flying white strokes [Figure 35] incorporate different saturations of black. Source: Jin Dian Shan interview with Sheila Labatt, Shanghai, April 1, 2013

It is often associated with Huáng Bīnhóng (黃賓虹 1865–1955) – considered one of the last of the literati painters – who is known for his dense, yet luminous landscapes [Figure 39].¹²⁵



Figure 39 *Sitting in the Rain on Mount Qingcheng*, 1933, Huang Binhong, ink and colour on paper, demonstrating the Five Colours of Black, 87x44cm hanging scroll. Collection: Zhejiang Provincial Museum, Hangzhou

¹²⁵ Huáng Bīnhóng developed his own ‘Seven Methods of Ink’ principles but the Five Colours of Black are more commonly referred to in connection with his work. See Guan Zhi, ‘Seven Principles of Brush and Ink: The Aesthetic Principles of Brush and Ink in the Field of Traditional Chinese Brush and Ink Painting’, *Majestic Ink*, 2017 <http://www.inkgz.com/blog/seven-principles-of-brush-and-ink-the-aesthetic-principles-of-b> [accessed 28 May 2017] and Chen Xiao, ‘The Untrammelled Brushwork: Huang Binhong’s Late Landscape Paintings’, *Hong Kong University of Science and Technology, Virginia Review of Asian Studies*, (2013), pp. 143–68

c) *Landscape*

Traditional landscape painting is considered – along with calligraphy and poetry (the Three Perfections) – the highest art form in China. In the ultimate tribute to the genre, US painter Ad Reinhardt viewed Chinese landscape painting as ‘one of the greatest achievements in art and human history’¹²⁶ and described these landscapes as:

[...] at once organized, organic, atmospheric and airless, immanent and transcendent, ideal, unreal, and most real. They are complete, self-contained, absolute, rational, perfect, serene, silent, monumental, and universal. [...] Some are formless, lightless, spaceless, timeless, a “weighted nothingness” with no explanations, no meanings, nothing to point out or pin down.¹²⁷

His own *Black* series paintings – his ‘ultimate paintings’¹²⁸ – were inspired by ‘monotonal Chinese paintings rather than Western painting’s concepts of light and dark’ [Figure 40].¹²⁹



Figure 40 *Black* series, c.1963, Ad Reinhardt, oil on canvas, works inspired by Chinese landscape painting. Photo credit: John Loengard; The LIFE Picture Collection

¹²⁶ Reinhardt, Ad, ‘Cycles Through the Chinese Landscape’, in *Art-as-Art: The Selected Writings of Ad Reinhardt*, ed. by Barbara Rose (Berkeley: University of California Press, 1991), pp. 212–215, p. 215

¹²⁷ *Ibid.* p. 215

¹²⁸ Tate, ‘Ad Reinhardt: 1913–1967’, *Art and Artists*

<<http://www.tate.org.uk/art/artists/ad-reinhardt-1826>> [accessed 2 October 2017]

¹²⁹ The Museum of Modern Art, ‘Focus: Ad Reinhardt and Mark Rothko’ (gallery label), *MoMA, The Museum of Modern Art*, 2008

<<https://www.moma.org/collection/works/78976>> [accessed 10 march 2017]

In traditional Chinese landscapes, inspiration comes only partly from nature; according to Li Dongxu, much more is based on ‘the artist following his mind or the mental treatment of what he sees’.¹³⁰ The idea is not to replicate a scene but to capture its *qi* (气) (ch’i), its essence or life force¹³¹. Spiritual values therefore take priority over realistic expression [Figure 41]. To Reinhardt, the landscapes are at once ‘unreal and most real’.¹³²



Figure 41 *The Kangxi Emperor's Southern Inspection Tour, Scroll Three: Ji'nan to Mount Tai*, c.1698, Wang Hui, ink and colour on silk, traditional Chinese landscape, alive with expression, movement and *qi*, 68x1394cm handscroll. Collection: Metropolitan Museum of Art, New York (1979.5a-d)

Since the objective is not to replicate nature, Chinese landscapes are usually painted in the studio, from memory, rather than *en plein air*. There is no need for the painter to remain before his subject, since true artistry is said to come from the artist's ‘heart-mind’ (心 *xīn*),¹³³ a concept that loosely translates as

¹³⁰ Li Dongxu, *Chinese Landscape Painting*, trans. by Wen Jingen and Pauline Cherrett (Beijing: Foreign Language Press, 2009), p. 15

¹³¹ *qi* 气, the Taoist philosophy of energy flow, is a ‘vital force’ that exists in all living organisms. (The character 气 can also be translated as breath.) The concept permeates Northeast Asian culture and features extensively in traditional Chinese medicine and the martial arts. In landscape painting, it refers to the spirit of a landscape, as if it were alive with energy.

¹³² Reinhardt (1991), p. 215

¹³³ Wang Qin interview with Sheila Labatt re: Heart/Mind 心 and the Chinese Feel 中国感觉 – The Philosophy and Intangible Qualities of Chinese Painting, Shanghai, 1 April, 2013

'spirit'.¹³⁴ For this reason, Maxwell Hearn refers to them as 'mind landscapes'.¹³⁵

The concept of qì is not traditionally associated with Western drawing and painting. Still, these art forms can demonstrate the vital life force and spiritual values of qì, particularly if the artist had been in the Zone or a state of wúwéi as they were drawing or painting.¹³⁶

Pieter Bruegel the Elder's pen and ink drawing in Figure 42, for instance, conveys qì and many other characteristics of traditional Chinese landscapes. In fact, a Google search of images similar to *Mountain Landscape with River and Travelers* returns more Chinese landscape paintings than anything else, including important works such as those immediately preceding and following this Bruegel landscape: *The Kangxi Emperor's Southern Inspection Tour, Scroll Three: Ji'nan to Mount Tai* in Figure 41 and *Early Spring* in Figure 43.¹³⁷



Figure 42 *Mountain Landscape with River and Travelers*, 1553, Pieter Bruegel the Elder, pen and brown ink landscape drawing demonstrating energy and flow, and evoking qì, 23x 34cm. Collection: The British Museum, London (183006001)

It is difficult to identify concrete elements in a landscape painting that convey qì, in the way that one might discuss subject matter, colour or composition. For me,

¹³⁴ The character 心 (xīn) is used to refer to both the heart and the mind. In China, for example, mental health concerns are said to originate in the heart whereas they are said to come from the brain (mind) in the West.

¹³⁵ Maxwell Hearn, 'Landscape Painting in Chinese Art', *Heilbrunn Timeline of Art History. New York: The Metropolitan Museum of Art, 2000–*, 2008 <http://www.metmuseum.org/toah/hd/chin/hd_chin.htm> [accessed 15 April 2016]

¹³⁶ See Chapter II – Casting, Spontaneity and Flow > Spontaneity and Flow: Elusive Immediacy in Cast Glass > Spontaneity of Effect, shibusu (渋さ) and wúwéi (无为)

¹³⁷ Bruegel also created his landscapes from memory, in the studio, as the traditional Chinese landscape painters do.

some characteristics include dynamism that is expressed in the combination of heavy and light strokes, and painted and non-painted surfaces, both of which must balance the *yīn* and *yáng* (阴阳) of the work¹³⁸. Specific descriptors, though, are elusive. Whether a landscape demonstrates *qi* is subjective but is accepted as a given in widely-recognised masterpieces.

In some ways, a *qi*-imbued Chinese landscape can be compared to an enlightened Buddhist monk who, after many years of practising meditation – which can be learned, like painting techniques – reaches a higher, spiritual realm that cannot be fully described.

Patricia Buckley explains that Chinese landscape painting is not a ‘window’ and that it need not replicate the mechanics of vision by viewing a scene from a single angle.¹³⁹ It can depict multiple views and even multiple seasons in the same image – as if the painter were walking by and observing the scene from multiple vantage points. The first description of this phenomenon is attributed to literati painter Guo Xi (郭熙 1020–1090), who named it the ‘angle of totality’ [Figure 43].¹⁴⁰ Wybe Kuitert also describes it as ‘floating perspective’ or the ‘three perspectives’: viewing the



Figure 43 *Early Spring*, 1072, Guo Xi, ink and light colour on silk, floating perspective or the 'angle of totality', 158x108cm. Collection: National Palace Museum, Taipei (故-畫-000053-00000)

¹³⁸ *Yīn* and *yáng* describe how opposite forces are complementary and interdependent in all aspects of life, and include dualities found in Chinese painting, such as light and dark.

¹³⁹ Patricia Buckley Ebrey, ‘Guo Xi’s *Early Spring*’, *A Visual Sourcebook for Chinese Civilization*, nd

<<https://depts.washington.edu/chinaciv/painting/4Indguox.htm>> [accessed 25 November 2016]

¹⁴⁰ Yu Yibo, ‘Guo Xi’, *China Online Museum*, nd

<<http://www.comuseum.com/painting/masters/guo-xi/>> [accessed 25 November 2016]

image simultaneously from a level aspect, up from below and down from above.¹⁴¹

The Chinese treatment of multiple viewpoints manifests differently from cubist landscapes. Neither traditional Chinese landscape nor cubist painters sought to copy nature or replicate a scene as if viewed through a window. They all believed that depicting a landscape from multiple vantage points gave a more complete view of the subject. They differed, though, in their motivations.

The approach to multiple viewpoints in cubism was playful and experimental and sought to reconfigure the idea of space by doing away with stale conventions in painting – possibly in response to the advent of photography and particularly as they related to the canons of perspective. It was not simply a style or 'look' but an entirely new way of depicting space. Chinese landscape artists, on the other hand, followed generations of stylistically and motivationally similar approaches, painting from memory and the soul/mind, rather than exploring radically new forms of expression.

Traditional Chinese and cubist landscapes also differ aesthetically. The cubists created images within a flat, geometric framework. They analysed the subject from different angles, breaking it down into planes and pure form and reassembled the parts to create a collage effect [Figure 44].



Figure 44 *Landscape with Bridge*, 1909, Pablo Picasso, oil on canvas, cubist landscape painted from multiple vantage points, 81x100cm. Collection: Narodni Galerie, Prague

Chinese landscapes, on the other hand, are far less abstract and represent multiple viewpoints more subtly, shifting organically among them, rather than using hard lines, like the cubists often did, or creating dramatic juxtapositions with the elements [Figure 43].

¹⁴¹ Wybe Kuitert, *Themes, Scenes, and Taste in the History of Japanese Garden Art*, Japonica Neerlandica, 3 (Amsterdam: Gieben, 1988), p. 75

Chinese landscape painting is generally more difficult than calligraphy for Westerners to appreciate. They do not follow the rigid canons of modelling or linear perspective, such as vanishing points and foreshortening, and can therefore seem flat and perhaps even rudimentary. As James Elkins writes, Westerners often consider Chinese landscapes flat, and opine that perspective is non-existent.¹⁴² Benjamin March, though, explains that Chinese landscapes do, indeed, suggest three-dimensionality based on different conventions¹⁴³.

The seminal seventeenth century book on Chinese painting, *The Mustard Seed Garden Manual of Painting*, for example, instructs landscape painting novices to increase perspective in height as follows:

Draw in springs and waterfalls; wild geese may be drawn flying around the base of the mountains of a thousand *hsin*,¹⁴⁴ and huts may be placed at three different levels on the mountain. If that doesn't convey perspective in height, what does?¹⁴⁵

The manual also explains methods for achieving a sense of depth and extension: 'a light ink wash applied on the back of the picture will [seep through to] produce an effect of distant trees in a landscape in snow'.¹⁴⁶ Allowing the ink to soak through also illustrates one of the unique qualities of thin, absorbent, *xuān* paper.

Using traditional materials and ink washes, dots and lines, literati landscape painting emphasised spontaneous, abstract expressionism, centuries before American abstract expressionists like Jackson Pollock, Franz Kline and others

¹⁴² James Elkins, *Chinese Landscape Painting as Western Art History* (Hong Kong ; London: Hong Kong University Press, 2010), p. 13

¹⁴³ Benjamin March, 'A Note on Perspective in Chinese Painting', *The China Journal*, VII (1927), pp. 69–72

¹⁴⁴ A *hsin* is about nine and a half feet.

¹⁴⁵ Sze, Mai-mai, *The Mustard Seed Garden Manual of Painting: Jie Zi Yuan Hua Zhuan, 1679–1701: A Facsimile of the 1887–1888 Shanghai Edition*, ed. & trans. by Mai-mai Sze, Bollingen Series (Princeton, NJ: Princeton University Press, 1977), p. 163

¹⁴⁶ Sze, p. 100

did in the twentieth century. They, too, emphasised subconscious creation but their work differed both aesthetically and technically.



Figure 45 *Yellow Islands*, 1952, Jackson Pollock, oil on canvas, non-representational abstract expressionist landscape, 144x185cm. Collection: Tate, London (T00436)

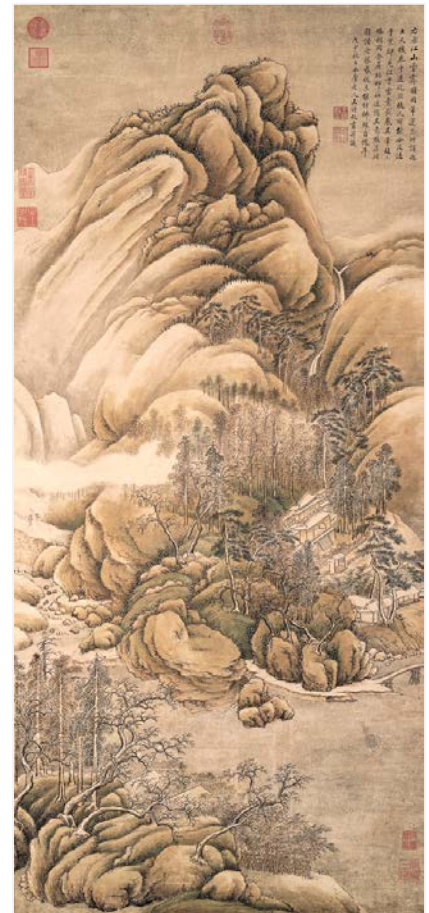

Figure 46 After Wang Wei's *Clearing of Rivers and Mountains after Snow*, 1668, Wang Shimin, ink on paper, vertical format landscape, abstract-expressionistic yet recognisable as a landscape, 134x60cm hanging scroll. Collection: National Palace Museum, Taipei (故-畫-000683-00000)

Chinese landscapes are not entirely abstract. Whereas Pollock painted intensely and vigorously to create entirely unrecognisable landscapes [Figure 45],¹⁴⁷ Chinese landscapes are painted more figuratively [Figure 46], in as calm, meditative and serene a state as possible. Although literati painters worked spontaneously, their work was still highly structured, with the relationships among the elements representing complex symbolism.¹⁴⁸

¹⁴⁷ Kim Evans, *Portrait of an Artist: Jackson Pollock*, 1987 <<https://www.youtube.com/watch?v=uy1SXVAIrDI>> [accessed 12 December 2016]

¹⁴⁸ Symbolism, in Chinese landscape painting, is inconsistently described. Some artists and scholars even maintain that symbolism does not exist at all. Xue (Shelly) Lü interview with Sheila Labatt re: Colours of Ink (水墨) and Symbolism, London, 18 June, 2017. A discussion of symbolism in Chinese landscape painting is outside the scope of this research, in which only the characteristics of brush marks are relevant.

Finally, Chinese traditional landscapes are commonly painted in high-ratio, horizontal or vertical format, where ratios of up to 1:27 are not unheard of. A high proportion is also in vertical format [Figure 46], whereas Western landscapes are usually painted in horizontal format. Indeed, as a concept derived from Western landscape painting, 'landscape' (as opposed to 'portrait') orientation in printing and computing indicates that a page is designed to be viewed horizontally.

6. Colour and Chops

The primary colours used in Chinese painting are black on a white ground. In landscape painting, white is created by leaving the paper or silk blank, unlike traditional Western oil paintings in which white would be painted.

The practice of leaving empty space (留白 *liú bái*, lit. remain white) in a Chinese painting [Figure 47] is rooted in Daoist and Zen Buddhist philosophies. Laozi's 老子 (Lao Tsu) second century BC *Dao de Jing* (Tao Te-ching) describes the concept of empty space in Daoism by comparing the void between heaven and earth to bellows, which are 'empty but do not collapse'.¹⁴⁹ In Zen Buddhism,



Figure 47 *White Clouds at the Xiao and Xiang Rivers*, 1627, Dong Qichang, ink on paper, leaving blank space. 'Form does not differ from emptiness, emptiness does not differ from form.' 29x341cm handscroll. Collection: Liaoning Provincial Museum, Shenyang

¹⁴⁹ Lao Zi, 'The Canon of Reason and Virtue (Lao-Tze's Tao Teh King)', trans. by D.T. Suzuki and Paul Carus, *1913 Translation of Second Century Text, Chapter 5—The Function of Emptiness* <<http://www.sacred-texts.com/tao/crv/>> [accessed 29 August 2017]

the Paramita Hridaya Sutra teaches that ‘form does not differ from emptiness, emptiness does not differ from form’.¹⁵⁰

These teachings had a significant impact on Chinese painting – as well as other arts, such as literature and music¹⁵¹ – and are considered critical in landscape painting.¹⁵²

Empty space in Chinese painting is different from the Western compositional principle of ‘negative space’, which helps define the subject, or positive space. Negative space, in English, also connotes a lesser feature and is not typically the subject of a painting. In Chinese painting, though, neither black nor white is favoured as the subject of the image. Blank space symbolises water (among other things), which is exactly one half of the Chinese word for landscape 山水, (shān shuǐ), or mountain water. Form, therefore, ‘does not differ from emptiness’.

Based on yīn and yáng principles, painted and non-painted spaces should balance each other and, in this respect, empty space in Chinese painting is akin to positive/negative composition practices in Western art.

The rhythmic vitality of the white spaces also defines the quality of the work’s qì. He Weimin explains, for example, that ‘when qì is still, a painting appears tranquil; when qì moves then a painting is dynamic and full of life’.¹⁵³

¹⁵⁰ Seung Sahn, *The Compass of Zen*, ed. by Hyon Gak, Shambhala Dragon Editions (Boston: Shambhala Publications, 1997), p. 130

¹⁵¹ Xue (Shelly) Lü. WeChat message to Sheila Labatt, ‘Leaving Blank’, 22 June 2017

¹⁵² Jin Dian Shan (2013) suggested to me that the concept of ‘leaving blank’ is also important in calligraphy.

¹⁵³ He Weimin, ‘The Mystery of Empty Space: Tradition in 20th Century Chinese Painting’, *The Ashmolean*, 2005

<http://www.heweimin.org/Texts/mystery_of_empty_space.pdf> [accessed 29 August 2017]

So important is the principle of leaving blank space in Chinese landscape painting that:

If one is able to realize how the ancients applied their
minds to the absence of brush and ink, one is not far from
reaching the divine quality in painting.
Yun Shouping (1633–1690)¹⁵⁴

Although white is the most important *colour* in Chinese landscape painting, others are also used. Many Chinese painters, though, have considered colour to be 'superficial, fleeting and elusive', according to Aschwin Lippe.¹⁵⁵

Traditional artists, notably the literati and the Traditionalist painters of the Qing (Ch'ing) Dynasty (1644–1912), for example, confined themselves to working in black on white because they considered colour a distraction. Maxwell Hearn explains that they also rejected the changeable qualities of light and shadow as a means of modelling, along with opaque pigments to conceal mistakes. Instead, they relied on line – the 'indelible mark of the inked brush'.¹⁵⁶

Not only did the literati consider pure brush and black ink the most authentic method of painting, the interference of other colours, particularly opaque ones, would have diminished the natural sheen of Chinese ink and the work's qì.

As in black and white photography, eschewing colour in Chinese painting produces stronger imagery, in my opinion. In *Phantom Landscape II, No. 1*, [Figure 48], for example, Yang Yongliang celebrates the power of black and white literati-style landscape painting in his digitally-manipulated contemporary photographic works, depicting dystopian references (densely-stacked sky scrapers, construction cranes and power lines).¹⁵⁷

¹⁵⁴ Ibid.

¹⁵⁵ Aschwin Lippe, 'The Waterfall', *The Metropolitan Museum of Art Bulletin New Series*, 12 (1953), p. 60

¹⁵⁶ Maxwell Hearn, 'Chinese Painting', *Heilbrunn Timeline of Art History, The Metropolitan Museum of Modern Art*, 2008
<http://www.metmuseum.org/toah/hd/chin/hd_chin.htm> [accessed 20 August 2017]

¹⁵⁷ Yang Yongliang also makes black and white videos using contemporary dystopian references to animate black and white literati-style landscape

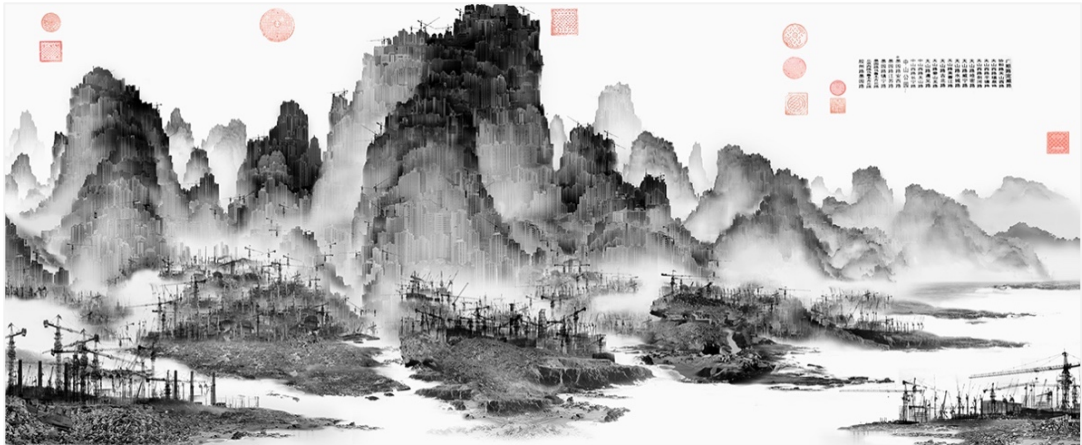

Figure 48 *Phantom Landscape II, No. 1*, 2006, Yang Yongliang, ink jet print, black and white literati-style landscape using digitally-manipulated photographs of factories, construction cranes, power lines and densely-stacked skyscrapers, 60x132cm. ©Yang Yongliang:

Although Chinese colours have been characterised technically as paint (suspended pigment) rather than ink (a colloid),¹⁵⁸ Chinese paintings are still referred to as ‘black water’ (ink) pictures (水墨画 *shuǐmòhuà*), probably because of their long association with ink painting.¹⁵⁹

Colour is used in moderation in traditional landscape painting and, according to Henry Li, is considered the ‘guest of the ink, rather than the host’.¹⁶⁰ Along with black and white, the standard colours are muted and diluted red, yellow and

paintings in digital media. See: Yang, Yongliang, *Phantom Landscape* (Yang Yongliang, 2010) <<http://www.yangyongliang.com/video/63.html?a=1>> [accessed 10 August 2017], Yang Yongliang, *Before the Rain* (Yang Yongliang, 2010) <<http://www.yangyongliang.com/video/64.htm>> [accessed 10 August 2017] and Yang Yongliang, *The Day of Perpetual Night* (Yang Yongliang, 2012) <<http://www.yangyongliang.com/video/60.html>> [accessed 10 August 2017]

¹⁵⁸ Chemistry World, ‘Ink Chemistry: There’s More to Ink than Meets the Eye, Says Joy Kunjappu’, *Chemistry World, The Royal Society of Chemistry*, 2003 <<https://www.chemistryworld.com/news/ink-chemistry/3002158.article>> [accessed 29 August 2017]

¹⁵⁹ Shuǐmò (水墨) translates as ‘ink’ but when the characters are read separately, they can mean water (水, Shuǐ) and black (墨, mò, when used as an adjective), respectively.

¹⁶⁰ Henry Li, *What Is the Difference between Chinese Painting Ink and Watercolour?*, Blue Heron Arts, 2016 <<http://painting-art.wonderhowto.com/how-to/understanding-difference-between-ink-watercolor-294082/>> [accessed 23 November 2016]

qīng (青), a combination of green and blue ('grue'), widely seen in Tang Dynasty landscapes (618–907) [Figure 49].¹⁶¹

Black ink comes from soot but the colour pigments come either from plant/vegetable dyes or minerals. The organic pigments are transparent and the mineral ones are opaque.



Figure 49 *Emperor Minghuang's Journey to Shu*, Song Dynasty (960–1279), attributed to Li Zhaodao, ink on silk, showing 'grue' and other muted colours, 56x81cm hanging scroll. Collection: National Palace Museum, Taipei (中-畫-000003-00000)

The transparent colours are diluted and appear weak in contrast to saturated black. The stronger, opaque colours are applied to the back of the thin, absorbent xuān paper (in a blank area) and allowed to bleed through to the front, softening them in the process.

In contemporary landscape painting, artists have explored the opaque, mineral colours differently, in two ways.

Painting the colour directly on top of the black ink (which does not mix or turn muddy, due to its binder) gives it a jewel tone. When the colour is applied to a blank (white) area, it becomes particularly

bright and saturated [Figure 50]. In this project, I replicate the traditional colours in certain pieces.



Figure 50 *Splashed-Color Landscape*, 1965, Zhang Daqian, ink and colour on paper, showing vibrant, mineral colours, used on blank area on front surface of a contemporary Chinese landscape, 60x96cm. Collection: The Metropolitan Museum of Art, New York (1986.267.361)

¹⁶¹ Each of these colours also carries one or more symbolic meanings that accord with the complex *five-element* theory (五行 wǔ xíng) in Chinese philosophy and medicine to describe interactions and relationships among natural elements. See Hsüan Hua, *Secrets of the Five Elements: Age-Old Treasures from China* (Burlingame, CA: Buddhist Text translation Society, 2005)

A final note on colour concerns the ubiquitous red chop (seal),¹⁶² which is an integral part of Chinese painting.¹⁶³ One or more chop impressions – a saturated vermilion, known as Chinese red in China and the West alike (中国红 zhōngguó hóng) – are stamped onto landscapes and calligraphy in lieu of a signature.¹⁶⁴



Figure 51
Vermilion imprint
of the Qianlong
Emperor's white
jade seal, carved
c.1793, bearing
the inscription 自
强不息 (zìqiáng
bùxī, strive
continuously
to become
stronger), 4x4cm.
Source:
sothebys.com/en/a
uctions/ecatalogue
/2017/important-
chinese-art-
hk0745/lot.3623

Since chops are traditionally hand-carved into stone or wood, they are considered unduplicable, theoretically accessible only to their owner, and therefore suitable for use as one's unique mark or identifier. Some people have several chops, which are used for different purposes, such as signing personal correspondence, official documents, paintings or calligraphy. They might also have chops that bear a favourite saying, such as the Qianlong Emperor's famous seal, c. 1793, with the inscription 自强不息 (zì qiáng bù xī) meaning to 'strive continuously to become stronger' [Figure 51].

Whereas Western artists traditionally sign their work once, often in the lower right corner of a painting, a Chinese painter places their chop(s) in compositionally strategic locations.

¹⁶² I am accustomed to using 'chop' instead of 'seal' and do so in this thesis. The name chop was adapted as 'Pigeon English in the Chinese ports' from the Hindi word chapa meaning stamp and is the word that I use. Source: Henry Yule, and A. C. Burnell, 'Hobson-Jobson: A Glossary of Colloquial Anglo-Indian Words and Phrases, and of Kindred Terms, Etymological, Historical, Geographical and Discursive, Article "Chop"', ed. by William Crooke (Online Edition, 1903)
<https://archive.org/stream/hobsonjobsonagl02croogoog/hobsonjobsonagl02croogoog_djvu.txt> [accessed 25 November 2016]

¹⁶³ The paste used with the chop is traditionally made from cinnabar.

¹⁶⁴ Although a person's name is represented in red, using a chop, it is generally considered back luck to write a person's name in red ink because, in ancient times, red was the colour in which the names of the deceased were written. Even today, people (including myself) are superstitious about writing names in red ink.

For centuries, it has also been common practice for scholars and collectors to affix their own chop to someone else's work, in appreciation of the masterpiece [Figure 52]. They might also add their own colophon – often poetry that they deem relevant to a painting's subject matter – in a compositionally appropriate location.

Another person's signature or writing on a Western painting is usually considered vandalism but the Chinese practice of adding a chop or poetry to someone else's work elevates its status. In contemporary terms, it is equivalent to 'liking' another person's post on Facebook. It also helps to date particularly old paintings by indicating their provenance.

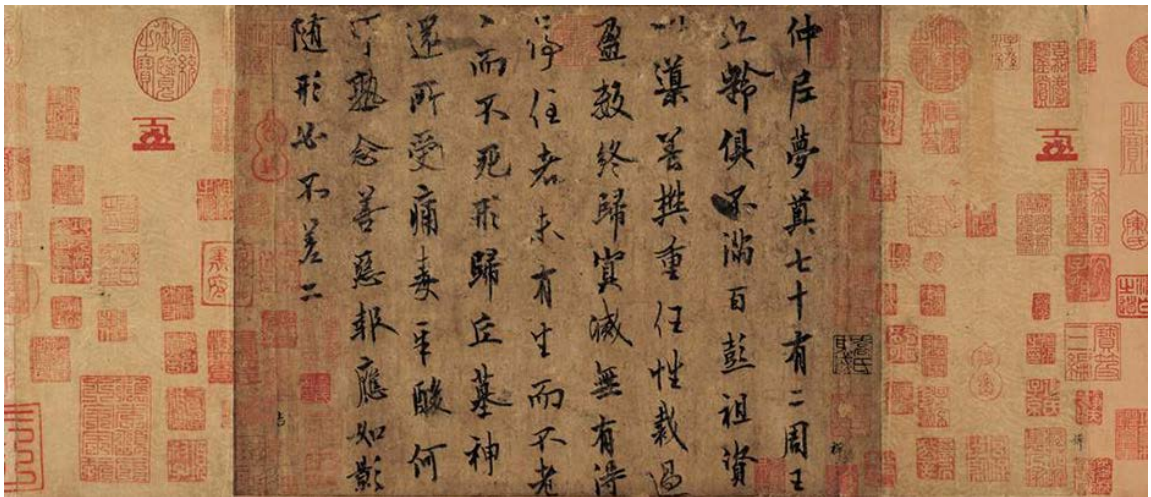

Figure 52 *In Memory of Confucius in Dream* (仲尼梦奠帖), date unknown (627–641), Ouyang Xun, regarded as the best example of Standard script calligraphy in China, bearing many scholars' and collectors' chops, demonstrating widespread appreciation of the work, 34x26cm. Collection: Liaoning Provincial Museum, Shenyang

Chops are still used, whether on important corporate and government documents or on mundane ones, like bank slips. Nowadays, they are usually affixed in addition to a person's written signature – a practice adopted from the West.

Vermillion seals have, in turn, been adopted by Western artists [Figure 53], though they have yet to be accepted in the West as an alternative to one's signature. Contemporary Chinese artists are using chops as subject matter rather than as an identifier [Figure 54].



Figure 53 *Ink Fall*, 2009, Denis Brown, giclée print on watercolour paper, Western contemporary calligrapher uses red Chinese chops in conjunction with his signature, 48x33cm. Source: quillskill.com/prints/inkfall



Figure 54 *Soaring*, 2010, Chen Jinhu 陈金虎, ink on paper, chops as subject matter rather than signature, 52x73cm. Source: Shanghai Ding Jie Gallery Catalogue

Digitally rendered chops are also being used in art and design around the world. Such are the beauty and captivating hold of this ancient Chinese symbol and practice.

7. Ink and the Third Dimension

a) *The Third Dimension Problem in Art*

Ever since Einstein got us thinking about the fourth dimension and string theorists got us worried about ten and eleven dimensions, we have not really given serious thought to the mundane old third dimension.

Venkatesh Rao¹⁶⁵

In Euclidean geometry, the first dimension is described as ‘length without breadth’ that we read as a line.¹⁶⁶ A painted line, though, is thick (more than a series of points without breadth) and is better described as ‘three points in space, not lying in a straight line, through which a plane may be drawn’.¹⁶⁷ In other words, it has both length and breadth – however negligible – and must therefore be thought of as a two-dimensional plane.¹⁶⁸

It follows that the third dimension is a plane with depth.

This poses a problem in art. A board, painted on one surface, for example, might have depth yet be considered a two-dimensional work because the painted subject lies on a flat picture plane. The question is how thick (how much depth) such an object must be before it is deemed three-dimensional. For the purposes of this research, I believe that if an object or image is extruded from a two-dimensional plane, it remains as such, regardless of the extent to which it is extruded [Figure 55].

¹⁶⁵ Venkatesh Rao, ‘The Third Dimension Is Not Simple’, *Ribbonfarm: Experiments in Refracted Perception*, 2007 <<http://www.ribbonfarm.com/2007/07/11/the-third-dimension-is-not-simple/>> [accessed 13 June 2015]

¹⁶⁶ Proclus, *A Commentary on the First Book of Euclid’s Elements*, trans. by Glenn R. Morrow, Princeton Paperbacks (Princeton, NJ: Princeton University Press, 1970), p. 79

¹⁶⁷ Helmholtz, H, ‘The Origin and Meaning of Geometrical Axioms’, *Mind, Digital Edition Compiled by Gabriele Dörflinger, Heidelberg University Library, 2007*, 1 (1876), pp. 301–321 <<http://www.uni-heidelberg.de/helios/fachinfo/www/math/txt/Helmholtz/geo2e.pdf>> [accessed 23 April 2017], p. 301

¹⁶⁸ Proclus, p. 92



Figure 55 *LOVE*, 1966–1999, Robert Indiana, polychrome aluminum, the sculpture is an extrusion of two-dimensional imagery and is therefore two-dimensional, 366x366x183cm. Location: New York City. Photo: Hu Totya (2006)

The concept of the third dimension is, therefore, not as 'mundane' as Rao has suggested. It is difficult to describe in the world outside pure mathematics, which suggests that the third dimension is 'space without time'¹⁶⁹ and that our eyes interpret the third dimension only as a series of receding two-dimensional planes or, as Rob Bryanton says, a 'a huge collection of snapshots which are immensely, richly structured'.¹⁷⁰ Without the invisible fourth dimension (time), therefore, a three-dimensional object must be experienced in ways other than sight, such as through touch.

This problem is further complicated when an object is encased inside a transparent solid, like glass. It can be seen but not handled. Glass artist Antoine Leperlier has described this duality as allowing one to be granted 'simultaneous access to the interior and exterior dimensions'.¹⁷¹ How is one to know, though, whether the object inside the form is three-dimensional [Figure 56]?

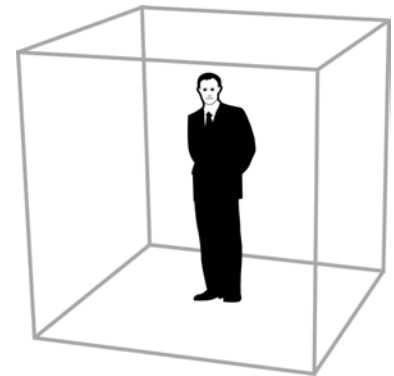

Figure 56 How do we know whether the figure is three-dimensional? Source: imaginingthetenthdimension.blogspot.co.uk/2012/01/poll-86-impossible-to-see-3rd-dimension

¹⁶⁹ Time (the fourth dimension), in addition to sight, is required in order to observe an object in the third dimension. A discussion of the fourth and higher dimensions is outside the scope of this research. Time, in the present context, relates to the moment at which molten glass ceases to flow and the 'ink' imagery becomes frozen, making 'time' and gravity visible. See Rob Bryanton, 'Imagining the Tenth Dimension: Impossible to See the Third Dimension?', 2012 <<http://imaginingthetenthdimension.blogspot.co.uk/2012/01/poll-86-impossible-to-see-3rd-dimension.html>> [accessed 17 June 2015]

¹⁷⁰ Rob Bryanton, *Imagining the Third Dimension* (Talking Dog Studios, 2011) <<http://www.youtube.com/watch?v=-D4swzK4sKk>> [accessed 17 June 2015]

¹⁷¹ Antoine Leperlier, *An Untimely Position* (Nancay, Fr: Galerie Capazza, 2002), Exhibition Catalogue <http://antoine-leperlier.com/medias/fichiers/an_untimely_position_english_text_pdf_32_ko.pdf> [accessed 12 March 2017]

Immanuel Kant proposed that the answer rests 'a priori on pure intuition'.¹⁷²
Edwin Abbott concurred and also addressed the sense of touch.¹⁷³

It is astonishing how much the Art – or I may almost call it
instinct – of Sight Recognition is developed by the habitual
practice of it and by the avoidance of the custom of feeling.

In glass terms, Leperlier speaks to the issue of inclusions in terms of the
imagination and the mental dimension:¹⁷⁴

It is by passing through this transparent obstacle that we
move from the world of reality to the world of the
imagination. Thanks to the image of this divide, we slip
from physical space to the mental dimension.

Although Kant's 'pure intuition', Abbott's 'instinct' and Leperlier's 'imagination'
describe how one might poetically define a three-dimensional inclusion, I
needed a more concrete method for evaluating whether the inclusions in my
glasswork were three-dimensional and within the parameters of the project.

Based on fundamental Euclidean principles and my view that extruded imagery
is two-dimensional, however far it is extruded, my criteria for defining three-
dimensional inclusions are: they are readable from all angles as a series of
receding two-dimensional picture planes (that they exhibit depth of field) and
from no angle as a unidimensional line, however thick.

¹⁷² Andrew Janiak, 'Kant's Views on Space and Time', *The Stanford Encyclopedia of Philosophy*, 2016
<<https://plato.stanford.edu/archives/win2016/entries/kant-spacetime/>>
[accessed 20 August 2017]

¹⁷³ Edwin A. Abbott, *Flatland: A Romance of Many Dimensions by A Square*,
Dover Thrift Editions (New York: Dover Publications, 1992), p. 21

¹⁷⁴ Leperlier, 2002



Figure 57 永 (yǒng), 2012, Sheila Labatt, three-quarter view, hotworked glass, refraction and depth create apparently three-dimensional, calligraphic inclusion, 10x10x10cm. Photo: Sheila Labatt



Figure 58 永 (yǒng), 2012, Sheila Labatt, top view, encased image reads as segments of unidimensional lines and is therefore two-dimensional. Photo: Sheila Labatt

The inclusions in Figure 57, for instance, appear three-dimensional because they exhibit depth of field. When viewed from above, however, the elements read as relatively unidimensional lines [Figure 58]. The inclusions are, therefore, two-dimensional, based on my assessment criteria, because the piece cannot be viewed from all angles as a series of receding two-dimensional picture planes. In other words, depth of field from all sides is not present.

b) *Calligraphy and Landscape Motifs*

The following discussion contextualises this research as to the dimensionality of inclusions that evoke Chinese calligraphy or landscape. These objects are not all encased in a transparent solid but, based on an assumption that touch is not an option, I apply my definition to them as if they were, to illustrate the difficulty of rendering Chinese painting in the third dimension.¹⁷⁵

¹⁷⁵ In Chapters IV – Glass and VI – Results, I apply the principles developed in this section to evaluate glasswork and inclusions.

(i) *Two-dimensional Rendering*

Ancient Chinese steles¹⁷⁶ replicate brush and ink calligraphy carved in stone [Figure 59]. While mathematically three-dimensional, in that both the stone and the carving occupy space on three axes (depth), the lines have been negatively extruded from a flat surface and must therefore be considered two-dimensional. (One might also assume that the stele was not originally conceived, in form and intention, to be a sculpture, as William Tucker suggests has traditionally been the case in relation to object-based works.)¹⁷⁷



Figure 59 Carved stele (detail), Yan style Chinese calligraphy, Stele Forest museum, Xian, China. Photo: Tony Y.J. Chou (2008)

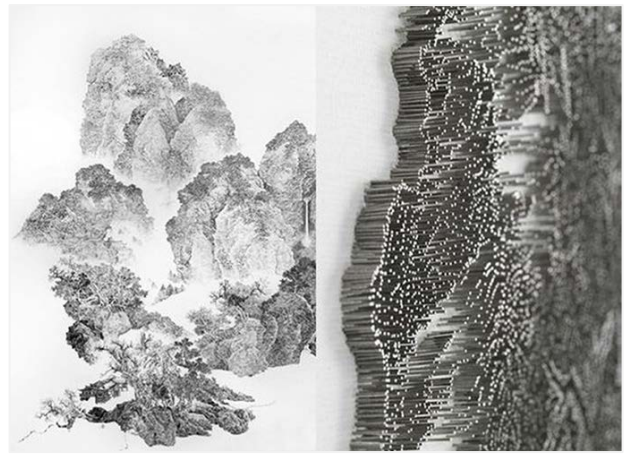

Figure 60 *Mosquito Nails Painting* (part of a series), c.2010, Chen Chun-Hao. 'Mosquito nail' reinterpretation of a Song Dynasty landscape painting (left). Detail (right). Source: ignant.com/2012/06/25/nail-art/ © Chen Chun-Hao

In the contemporary context, Chen Chun-hao (Howard Chen) uses a nail gun to drive up to 1 million headless 'mosquito nails' into canvas-covered wood, to replicate masterpieces of black and white Song Dynasty literati landscape painting [Figure 60]. Using this technique, he adds bas relief to traditional landscape, in a pointillist or digitally pixilated aesthetic. As with Indiana's *LOVE* [Figure 55], Chen's mosquito nail piece is an extrusion of a landscape image,

¹⁷⁶ Commemorative stone monuments, often several metres tall, carved with poetry or other enlightening text. They usually replicate masterful works of calligraphy, including that of emperors and other high officials. They are therefore used for ink rubbings, or displayed in museums as well as private homes. Making stele rubbings is an especially popular activity among tourists visiting Xian's famous Stele Forest museum, which houses some 3,000 steles.
¹⁷⁷ William Tucker, *The Language of Sculpture* (London: Thames and Hudson, 1974), p. 107

rather than a three-dimensional rendering of it, and is therefore two-dimensional.

Another difficulty in interpreting the dimensionality of ink painting arises when calligraphic lines, for example, are painted onto a surface like the ceramic *Writing IX Temple Jar* [Figure 61]. Although the jar is three-dimensional, the painting is not, since it has been executed on a continuous surface that can notionally be rolled out into a single plane, rather than as a series of receding ones.

This thought experiment can be illustrated by the technique I used to make 永 (yǒng) [Figure 57 and Figure 58].



Figure 61 *Writing IX Temple Jar*, 2013, Jared FitzGerald, porcelain, abstract calligraphic lines on surface of three-dimensional object that can notionally be rolled out into a two-dimensional plane, 54x51cm.

Source: fitzgeraldfinearts.com/exhibitions/houghton-international-fair-2014/selected-works?view=slider#23

To create the inclusions, I painted black (the character 永 [Figure 62]) and vermilion (an allusion to chops [Figure 63]) glass powders, suspended in acrylic medium, on fragments of eggshell.¹⁷⁸ The eggshells were then rolled up on a



Figure 62 The character 永 (yǒng) painted on eggshell piece, using black glass powder and acrylic medium. Photo: Sheila Labatt

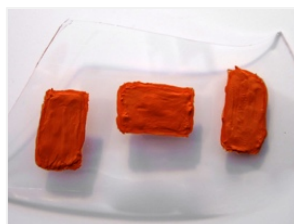

Figure 63 Allusion to chops, painted on eggshell piece using vermilion glass powder and acrylic medium. Photo: Sheila Labatt

marver¹⁷⁹ and fused onto an oblong gather¹⁸⁰ of hot glass. This was then covered over by a second, clear gather, ensuring that the combined inclusion was entirely embedded, and shaped into a cuboid form.

Just as the image 永 in Figure 62 can be rolled up onto a gather of hot glass,

¹⁷⁸ Thinly-blown (under 1mm) glass pieces.

¹⁷⁹ A flat, steel surface from which the eggshells could be 'picked up' (caused to adhere to the hot glass) by rolling the hot glass over them.

¹⁸⁰ The process of collecting molten glass from a furnace using a long, steel glassblowing tube (blowpipe) or rod (punty).

so it can theoretically be rolled out again, into its original two-dimensional form. The fact that the painted eggshells in Figure 62 and Figure 63 were rolled onto a cylinder is also the reason that the final image reads as two-dimensional lines, when viewed from the top, in Figure 58.



Figure 64 *Drinking Tea*, 2001-2003, Xue Lei, hand-painted porcelain, complex shapes in contemporary ceramic objects (cans), painted in traditional Jingdezhen blue. Source: Galerie Hubert Winter

For the same reason that the calligraphic marks on *Writing IX Temple Jar* are two-dimensional, the majority of contemporary artists purporting to have rendered Chinese brush and ink painting in the third dimension have not, in fact, done so. The imagery resides only on the surface of three-dimensional objects, however complex [Figure 64], and is therefore two-dimensional.

Dustin Yellin's sheet glass works house apparently three-dimensional, gestural ink lines and have been described, by Johnny Strategy and others, as three-dimensional [Figure 65].¹⁸¹

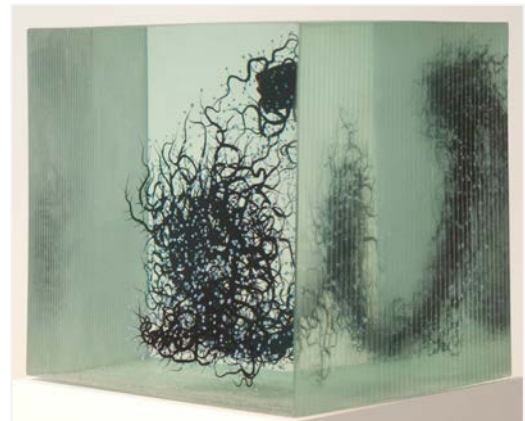

Figure 65 Untitled, c.2009, Dustin Yellin, two-dimensional, encased 'ink' imagery, dimensions unknown. Source: Samuel Freeman Gallery, Eden Disorder Exhibition, March 2010

Yellin's pieces are assembled from multiple layers of flat (two-dimensional) industrial sheet glass onto which lines have been painted in acrylic or collaged. When the object in Figure 65 is viewed from the front and back, the embedded imagery is read as two-dimensional receding planes and is therefore three-dimensional in that context. When viewed from the sides, though, it is clear that the object has been assembled from two-dimensional drawings, which read as unidimensional lines, meaning

¹⁸¹ Johnny Strategy, 'Psychogeographies: 3D Collages Encased in Layers of Glass by Dustin Yellin', 2014
<http://www.thisiscolossal.com/2014/03/psychogeographies-3d-collages-encased-in-layers-of-glass-by-dustin-yellin/> [accessed 9 January 2017]

that the image cannot be viewed differently from all angles. The inclusions are therefore two-dimensional. Indeed, in a Ted Talk, Yellin himself fleetingly describes his assemblages as 'double-sided', suggesting the second-dimension.¹⁸²

Finally, Lu Bin's *Fossil* [Figure 66] was inspired by ancient Chinese oracle bones¹⁸³ and its calligraphy has been carved in bas relief from the object's surface. The bone form is more complex than a flat stele, yet the raised calligraphy is still an extrusion that causes it to be two-dimensional. How then can Chinese calligraphy and landscape painting be rendered in the third dimension?



Figure 66 *Fossil*, 2004, Lu Bin, unglazed porcelain, bas relief carved characters evoke ancient oracle bones. 9x38x14cm. Collection: Sheila Labatt. Photo: Sheila Labatt

¹⁸² TED Talks NYC, *Dustin Yellin: A Journey Through the Mind of an Artist*, 2014
<https://www.ted.com/talks/dustin_yellin_a_journey_through_the_mind_of_an_artist> [accessed 25 November 2015], (3:18)

¹⁸³ Oracle bones were the shoulder blades of oxen or the flat, underside of a turtle's shell, which were carved into and used during the Shang Dynasty (c. 1600–1046 BCE) for divination. They are the earliest written records of Chinese civilisation. See Harold Miles Tanner, *From Neolithic Cultures through the Great Qing Empire (10,000 BCE–1799 CE)*, *China: A History* (Indianapolis: Hackett Publishing Company, 2010)

(ii) *Three-dimensional Rendering*

Three-dimensional Chinese landscapes have existed at least as far back as the Han dynasties (206 BC–9 AD and 25–220 AD), when some of the earliest landscape-inspired censers were created in pottery [Figure 67] and bronze [Figure 68].¹⁸⁴



Figure 67 Mountain-shaped censer, Western Han Dynasty (206 BC–AD 9), red earthenware with green glaze, Ø18x23cm. Collection: Lucy Maud Buckingham (1924.239)



Figure 68 Mountain-shaped censer, from the tomb of Liu Shen (d. 113 BCE), Western Han Dynasty, bronze with gold inlay, three-dimensional landscape, Ø12x26cm. Collection: Hebei Provincial Museum, Shijiazhuang

These ‘mountain censers’ (博山炉 *bó shān lú*) represent Mount Bo (*bó shān*), one of China’s five sacred mountains, and symbolise the realm of the immortals.¹⁸⁵ They can be viewed as series of unique receding planes, from all angles and are therefore truly three-dimensional interpretations of Chinese landscape painting.

¹⁸⁴ These incense burners are thought to have been used to perfume clothes and were, in some cases, adapted for religious purposes. The smoke emanating from the censers would have evoked clouds or mist in the mountains.

¹⁸⁵ Stephen Little and Shawn Eichman, *Taoism and the Arts of China* (Chicago: Art Institute of Chicago ; University of California Press, 2000), p. 37



Figure 69 *Under the Wave off Kanagawa*, c. 1830–32, Katsushika Hokusai, polychrome woodblock print, ink and colour on paper, 26x38cm. Collection: The Metropolitan Museum of Art, New York (JP1847)



Figure 70 *The Wave 浪*, 2005, Ai Weiwei, celadon-glazed ceramic, three-dimensional representation of stylised waves, 16x43x38cm. Source: metmuseum.org/exhibitions/. © Ai Weiwei

More recently, Ai Weiwei 艾未未 has worked in ceramics to represent a Northeast Asian wave motif in the third dimension [Figure 69 and Figure 70].

Ai's *Wave*, like the two censers, sits on a flat surface because it needs to be affixed to or sit on something. All three are otherwise three-dimensional in that they can be seen from all angles as distinct, receding two-dimensional surfaces, or planes.

Likewise, contemporary Singaporean sculptor, Chua Boon Kee 蔡汶家, creates Grass script calligraphy in the third dimension, in a variety of contemporary sculpture materials such as stainless steel, brass and resin.

In his architectural-scale 《饮水思源》 *Flowing* [Figure 71], located at 124 Shaftsbury Avenue in London's Chinatown, he has transcribed the four characters (饮水思源 yǐn shuǐ sī yuán) for the Chinese proverb 'when you drink water, think of its source', in reference to

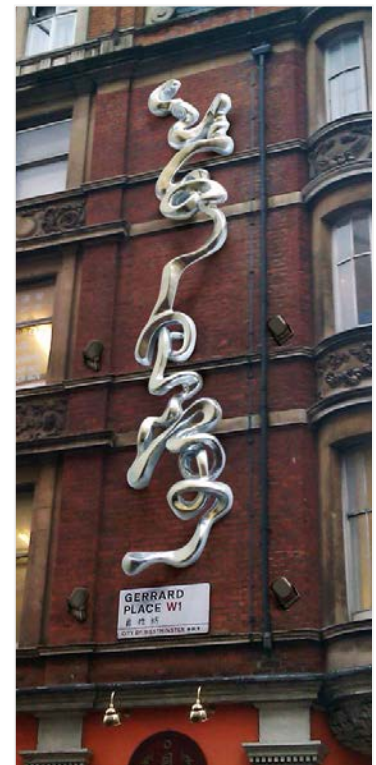

Figure 71 《饮水思源》 *Flowing*, 2014, Chua Boon Kee, forged stainless steel, large-scale, three-dimensional Grass script calligraphy. Location: 124 Shaftsbury Avenue, London

sustainable development.¹⁸⁶

He has abstracted the phrase into three-dimensional Grass script, possibly not legible even by those trained to read that script due to its altered dimensionality. By most local audiences, it is likely read as a gestural, abstract sculpture, which may or may not evoke language.

Finally, graceful, dynamic and rhythmic ink wash, in the third dimension, need not be sculpted at all. It exists in nature in the form of starling murmurations, which have always spoken to me as ink wash come to life, within actual landscapes [Figure 72].¹⁸⁷



Figure 72 Starling Murmuration in Gretna Green, 2013, 'ink wash' come to life. Photo credit: Owen Humphreys

¹⁸⁶ Chua Boon Kee, 《饮水思源》 *Flowing*, 2012 Winner of SUSTAIN Project – 3rd Landmark Sculpture for Chinatown, London., *The Sculpture Arts of Chua Boon Kee*, 2014

<http://www.chuaboonkee.com/Chua_Boon_Kee/Projects/Pages/yin_shui_si_yuan_Flowing.html> [accessed 20 November 2016]

¹⁸⁷ See Paul Bunyard, *Gretna Green Starling Murmurations*, Wild About Images, 2013 <<https://www.youtube.com/watch?v=M1Q-EbX6dso>> [accessed 5 May 2013]

8. Summary

Contemporary artists are exploring new media for reinventing the highest traditional Chinese fine art forms: brush and ink calligraphy and landscape painting. They are also using the work as social commentary, which was not the custom in traditional painting.

This chapter reviews the elements of calligraphy and landscape that those artists address and the characteristics that are the focus of the research: the dynamic, gently curving and tapering lines of Grass script calligraphy and the range of wash tones in literati-style landscape painting, described in English as the Five Colours of Black (墨分五色 *mò fēn wǔ sè*).

I briefly discuss the muted colours that are used sparingly in traditional landscape painting and the Daoist principle of 'leaving blank', making white the most important *colour* in landscapes, other than black. I also touch upon the vermilion chop (seal) that figures in all Chinese calligraphy and landscape painting, often multiple times.

I also explain the difficulty of describing the third dimension in art, particularly when objects are encased inside a clear, solid medium and cannot be touched. For research purposes, it is insufficient to rely on one's intuition to judge the dimensionality of inclusions. I therefore establish rules for assessing whether inclusions are indeed three-dimensional: they must be readable from all angles as a series of receding two-dimensional picture planes and from no angle as a unidimensional line, however thick.

Finally, I apply these rules to selected, ostensibly three-dimensional interpretations of Chinese landscape and calligraphy, to illustrate the difficulty of rendering these genres in the third dimension and as a reference for evaluating 'ink painting' inside glass.

IV GLASS

1. Introduction

In this chapter, I describe my glasswork and research objectives in the context of Chinese glassmaking history. First, I briefly outline the history of ancient Chinese glass because it informs aspects relevant to my own approach to glassmaking and aesthetics.

The next section explains the role of the Qing Dynasty emperors (1644–1912) in promoting the unique properties of glass beyond its ability to imitate more precious materials, as had been done in ancient glassmaking. Qing glassmakers were trained by European missionaries and developed high levels of craftsmanship to create decorative objects that exhibited a uniquely Chinese aesthetic. Glassmaking was interrupted, though, in the early twentieth century and was only revived nearly a century later.¹⁸⁸

I then detail the contemporary Studio Glass movement, which began on the Chinese mainland in 2000. In contrast to Qing Dynasty glassmakers, whose wares were purely decorative and destined for the Imperial Palace, this new generation of makers – also originally trained in Western techniques – began using glass as an expressive material. As had been the case throughout most of Chinese history, casting was the technique of choice, and only now are glassblowing and flameworking for creative purposes beginning to gain popularity.

In this section, I discuss the work of early Chinese studio glassmakers and, since I too was trained in casting during that period, explain my approach to

¹⁸⁸ Glassmaking for industrial purposes flourished during most of the twentieth century. By the early 1980s, China was the leading exporter of industrial glass in the world. See: Zhang Lin, 'Glass Art: A Shining Symbol of Chinese and Western Cultural Exchange', in *Now/Then: Influences of Qing Dynasty Glass on Contemporary Glass Art* (Shanghai: Shanghai University Press, 2014), p. 16

glassmaking and the inspiration for my work.

Finally, I survey contemporary glassmakers whose work contextualises my research, both technically and aesthetically. First, I look at the techniques of prominent artists who use bubbles and voids and the extent to which they distort inclusions during kiln casting. I begin with those whose bubbles barely move or affect inclusions and move through to those whose bubbles create greater distortions within cast objects. I then discuss the aesthetic context for my research by reviewing artists whose work addresses ink, generally, or in specific applications like brush and ink painting and calligraphy.

2. Ancient Chinese Glass: Materiality and Appreciation

Ancient Chinese glass refers to glass objects produced prior to the Qing Dynasty (1644–1912). Accounts of the very earliest Chinese glassmaking are inconsistently described and dated throughout the literature. Still, it is important to understand some of the ancient glassmaking history because it informs relevant aspects of contemporary Chinese glassmaking, in general, the practice of most (primarily Chinese) glassmakers who seek to evoke ink in cast glass and my own approach to glassmaking and aesthetics.

According to *5,000 Years of Glass*, considered the most authoritative English-language research on global glassmaking, glassmaking reached the Chinese region during the Zhou period (c. 1050–221 BC), centuries before China's unification under Emperor Qin Shi Huang (reigned 221–210 BC),¹⁸⁹ when glass 'eye beads' were probably copied from those of Western origin.¹⁹⁰

¹⁸⁹ Tait (2012)

¹⁹⁰ Gan Fuxi, Cheng Huan Sheng, Hu Yong Qing, Ma Bo, and Gu Dong Hong, 'Study on the Most Early Glass Eye-Beads in China Unearthed from Xu Jialing Tomb in Xichuan of Henan Province', *Science in China Press*, Science in China series E: Technological Sciences, 52 (2009), pp. 922–927
<<https://link.springer.com/content/pdf/10.1007/s11431-008-0341-0.pdf> >
[accessed 20 October 2017]

Casting was mastered during the Han Dynasty (221–206 BC),¹⁹¹ later than in other cultures, such as Mesopotamia, where cast glass can be traced back as far as the middle of the third millennium BC.¹⁹² Glassblowing arrived even later, some five centuries after its discovery in the Near East, and was probably introduced to China in 481 AD.¹⁹³ Glassblowing never caught on in ancient Chinese glassmaking because everyday vessels were ceramic and decorative, blown glass ones were imported from elsewhere. Casting (press-moulding)¹⁹⁴ remained the technique of choice because it could be used to copy more precious materials.

Whatever the precise timeline, glass was never appreciated in ancient China as it had been in the Roman Empire, the Islamic world and Europe, for either its decorative value or much of its materiality, particularly its transparency and fluidity. Instead, it was mostly used to imitate jade, which has been used in that region to produce ornaments such as jewellery, belt buckles, inlay for weapons and ritual objects, at least as far back as the Neolithic period,¹⁹⁵ millennia before the unification of China during the reign of Emperor Qin Shi Huang (reigned 220–210 BC).

Jade was the most precious stone in Ancient China,¹⁹⁶ which explains why cheaper glass replicas were so prevalent.¹⁹⁷ It represented power, as the

¹⁹¹ Tait, p. 140

¹⁹² Tait, p. 21

¹⁹³ Tait, p. 140

¹⁹⁴ Press-moulding is considered a casting process and involves sandwiching and shaping softened glass between two ceramic or metal moulds.

¹⁹⁵ In China, it began around 10,000 B.C. and concluded with the introduction of metallurgy about 8,000 years later. See: Department of Asian Art, 'Neolithic Period in China', *Heilbrunn Timeline of Art History. New York: The Metropolitan Museum of Art, 2000–, 2004*

<http://www.metmuseum.org/toah/hd/cneo/hd_cneo.htm> [accessed 8 January 2017]

¹⁹⁶ In China, it is said that gold has its price but jade is priceless and, according to legend, 'jade is worth 15 cities' (价值连城 jià zhí lián chéng). Source: Xue (Shelly) Lü interview with Sheila Labatt, London, 13 June, 2017

¹⁹⁷ Christopher F. Kim, *Early Chinese Lead-Barium Glass: Its Production and Use from the Warring States to Han Periods (475 BCE–220 CE)* (Providence, RI: Joukowsky Institute for Archaeology, Brown University, 2012), Professor Carolyn Swan, ARCH0305

emperors used it to decorate their weaponry. It also had spiritual connotations, including a 'close association with immortality',¹⁹⁸ due to the fact that it does not corrode (decay)¹⁹⁹ and that the emperors, imbued with the 'Mandate of Heaven' (天命 *tiānmìng*),²⁰⁰ were considered earthly representatives of the Divine.²⁰¹ In fact, the Chinese character for king, 王 (*wáng*), only differs from the character for jade, 玉 (*yù*), by one small dot in the lower right, indicating the close relationship between jade and the emperor in Chinese culture.

Even today, jade is considered an intrinsically superior material to glass and is thought to be alive with energy, love and protection. It is also a symbol of Confucian values such as virtue, benevolence, humility and loyalty, and is often worn in the form of bangles to protect the body and spirit of the wearer.²⁰² In Chinese culture, jade is therefore valued in the way that gold is in the West,²⁰³ and glass is still used to make fake jade, otherwise known as 'Peking Jade'.

Glass is ideal for copying jade: not only can it be brought to a high polish, but Chinese glass was also composed of large amounts of the crystal barium disilicate (BaSi_2O_5) in ancient times. Unlike the clearer soda-lime glasses that were being used in Western Asia and Mesopotamia at the time, the crystalline

<[¹⁹⁸ Ibid.](https://www.brown.edu/academics/archaeology/search/brown?query=Early%20Chinese%20Lead-Barium%20Glass%3A%20%20Its%20Production%20and%20Use%20from%20the%20Warring%20States%20to%20Han%20Periods%20(475%20BCE-220%20CE)> [accessed 20 October 2017], p. 14</p>
</div>
<div data-bbox=)

¹⁹⁹ John E. Hill, *Through the Jade Gate to Rome: A Study of the Silk Routes during the Later Han Dynasty 1st to 2nd Centuries CE: An Annotated Translation of the Chronicle on the 'Western Regions' in the Hou Hanshu* (Charleston, S.C.: BookSurge Publishing, 2009) p. 260

²⁰⁰ The 'Mandate of Heaven' (Tiānmìng 天命) philosophy concerned the rights of an emperor to rule. It is similar to the Western 'Divine Right' of kings but is not unconditional. It can be lost, for example, if the ruler is unjust or is overthrown. See: Jiang Yonglin, *The Mandate of Heaven and the Great Ming Code.*, trans. by Jiang Yonglin, Asian Law Series (Seattle, WA: University of Washington Press, 2010), p. 5

²⁰¹ Jessica Rawson, *Chinese Jade: From the Neolithic to the Qing* (London: The British Museum Press, 1995), p. 13

²⁰² Chiani Blue, 'Why Chinese Women Wear Jade Bracelets', *Vision Times*, 2015 <<http://www.visiontimes.com/2015/07/08/why-chinese-women-wear-jade-bracelets.html>> [accessed March 10 2017]

²⁰³ Rawson (1995), p. 13

Chinese glass was heavily devitrified,²⁰⁴ creating a translucent, turbid white colour and making it the only material²⁰⁵ at the time that could imitate over 20 types and colours of jade.²⁰⁶ In fact, glass is so well suited to copying jade that jade itself has even ‘on at least one occasion, been mistaken for glass’.²⁰⁷

For millennia, the Chinese have therefore cast and carved glass to imitate traditional jade objects, such as the *bì* (璧), since glass is cheaper and easier to carve [Figure 73]. *Bis* are round discs with a central hole, symbolising heaven.²⁰⁸ Some were intricately carved and some smooth, depending on the era in which they were made. They were symbols of status and power and were used in burial rituals, to protect the body and spirit of the deceased, as far back as the late Neolithic period, during the Hong Shan (4700–2900 BCE) and Liang Zhu cultures (3400–2250 BCE), well before writing and calligraphy began in China.²⁰⁹



Figure 73 Press-moulded, translucent glass *bì*, imitating jade, ritual burial disc, Han Dynasty (206 BC–220AD), Ø16x0.5cm. Collection: Corning: Museum of Glass (51.6.548)

Press-moulded glass *bì* fakes have been discovered in medium to small tombs, indicating that cheap, imitation jade was buried with commoners, whereas the more expensive, genuine jade was reserved for the elite classes.²¹⁰

That glass was considered an inferior material is also evidenced by the fact that it was not deemed worthy of inclusion in the seminal treatise on craftsmanship

²⁰⁴ Devitrification causes glass to become ‘unglassy’, due to surface or internal crystallisation. It is usually caused by poor annealing, overheating and other firing errors

²⁰⁵ Kim (2012), p. 16

²⁰⁶ Gan (2009), pp. 26–27

²⁰⁷ Rawson (1995), p. 421

²⁰⁸ Xue (Shelly) Lü, ‘The Investigation into the Development of Glass as an Expressive Medium in China through Direct Contact with Western Methods of Making, Decoration and Forming’ (PhD Thesis, University of Wolverhampton, 2009), p. 27

²⁰⁹ Kim (2012), p. 14,

²¹⁰ *Ibid.*, p. 14

in ancient China: the *Ancient Book of Diverse Crafts* (考工记 kǎo gōng jì).²¹¹

This is the earliest extant book on Chinese handicrafts and technology and covers over 20 different kinds of crafts such as pottery, metalwork, chariot and weapon design, and musical instrument making, but not glassmaking.

In the context of this research, therefore, ancient Chinese glass history is important in indicating that glassblowing was nearly non-existent, and that casting was the technique of preference throughout the ancient period. In addition, glass was never valued for its intrinsic properties but only as a medium for imitating more precious materials. Jade in particular.

3. Qing Dynasty Glass (1644–1912)

It was not until the Qing Dynasty, which lasted some three centuries, that, following 2,000 years of otherwise unbroken development,²¹² glassmaking reached its zenith. Glass became better appreciated than it had been in the past, when the German Jesuit priest and expert glassmaker Kilian Stumpf brought Western glassmaking techniques and recipes to China. At the request of the Kangxi Emperor (reigned 1662–1722), Stumpf created the first Imperial Glass Workshop in 1696, inside the walls of the Imperial City itself.

The Imperial Glass Workshop was one of 27 others that included workshops for clock-making and the crafts of jade, wood, lacquer, ceramics, ivory and others, near the Emperor's palace and next to what would, a year later, become the Jesuit (Catholic) church in Peking, as it was then known. Expert Chinese mould-makers and carvers were recruited for the workshop and were joined, occasionally, by Western glassmakers, including two notably-skilled French Jesuit glassmakers and missionaries, Gabriel-Léonard de Brossard and Pierre

²¹¹ Also known in English as the *Ancient Chinese Encyclopedia of Technology*, the book was compiled during the Spring Autumn Period (770–476 BC)

²¹² Zhang Rong, 'Foreword', in *Now/Then: Influences of Qing Dynasty Glass on Contemporary Glass Art* (Shanghai: Shanghai University Press, 2014), p. 19

d'Incarville, in the 1740s and 1750s.²¹³

Under the Qing emperors, Western glassmaking knowledge revived glassblowing techniques, which had not been used in China for nearly two millennia, bringing with it a new appreciation of the unique qualities of glass. It did not, however, alter the general Chinese preference for opaque glass. During this period, mould-blown glass was used extensively to imitate another traditional material – glazed ceramics [Figure 74].²¹⁴ These pieces (as well as imitation jade, which was still being produced) were not made for commercial purposes, but for the Emperor's pleasure.²¹⁵ Although these items were often given away as gifts, the yellow pieces were strictly reserved for the Emperor and his family, since yellow symbolised royalty in traditional Chinese culture.^{216,217}



Figure 74 Vase, imitating ceramics in mould-blown, opaque glass, from the period of Qing Emperor Yongzheng (r.1723–c.1735). Yellow wares were strictly reserved for the Emperor. Ø11x11cm. Collection: British Museum, London (1873.1215.1) ©2017 Trustees of the British Museum

A further appreciation of the properties of glass and its many decorative applications – beyond that of imitating jade and ceramics – developed during the Qianlong Emperor reign (1735–1796) of the Qing Dynasty. At that time, the Imperial Glass Workshop carvers, who had been recruited to cut glass to imitate jade, became expert at 'cameo' cutting, independently of Western influence.

²¹³ Emily Byrne Curtis, *Pure Brightness Shines Everywhere: The Glass of China*, ed. by Emily Byrne Curtis (Aldershot, UK ; Burlington, VT: Ashgate Publishing, 2004), p. 77

²¹⁴ It is unclear whether glass was used prior to the Qing Dynasty to imitate ceramics but we know that the blowing technique did not survive in ancient China. Glass vessels recovered from that period were usually of foreign origin or were cast/core formed.

²¹⁵ Curtis, p. 50

²¹⁶ Curtis, p. 78

²¹⁷ Today, in contrast, it can also symbolise pornography.



Figure 75 Pair of cameo cut, covered jars, Qing Dynasty, 18th Century, displaying advanced lapidary skills and rare traditional Chinese landscape motifs, Ø13x14cm. Collection: Suntory Museum of Art, Tokyo

Cameo cut glass dates back to ancient Rome (27 BC–68 AD).²¹⁸ In this technique, glass is blown in multiple layers of differently-coloured glass. The surface is then carved to reveal specific colours, depending on the depth of the cuts. The technique is therefore well suited to skilled jade carvers.

The resulting Qing cameo pieces displayed a uniquely Chinese character. They were usually decorated with traditional motifs: the plum (梅 méi), orchid (蘭 lán), bamboo (竹 zhú), and chrysanthemum (菊 jú), particularly popular in the nineteenth century. Bird and flower illustrations were also common, but landscape depiction was far less so [Figure 75].²¹⁹

Inspired by the discovery of the ancient Roman Portland Vase,²²⁰ cameo cut glass was not revived in the West until the eighteenth century.²²¹ By the late nineteenth century, English cameo glass was being cut to imitate Chinese motifs, in the chinoiserie style [Figure 76].

There is no evidence of Qing cameo cut glass imitating



Figure 76 1889 Exhibition vase, 1889, Thomas Webb & Sons, cameo cut glass in Chinoiserie style, H: 49.5cm. Source: <https://www.christies.com/lotfinder/Lot/a-thomas-webb-sons-cameo-glass-5845750-details.aspx>

²¹⁸ Trentinella, Rosemarie, 'Roman Cameo Glass', *Heilbrunn Timeline of Art History, The Metropolitan Museum of Modern Art*, 2003 http://www.metmuseum.org/toah/hd/rcam/hd_rcam.htm [accessed 10 May 2017]

²¹⁹ Xue (Shelly) Lü interview with Sheila Labatt re: Colours of Ink (水墨) and Symbolism, London, 18 June, 2017

²²⁰ The Portland Vase is the most important piece of ancient Roman cameo cut glass and is housed at the British Museum. It is dated c. 1–25 AD and was first recorded in the early seventeenth century. See: The British Museum, 'The Portland Vase', *The British Museum Online Collection* <http://www.britishmuseum.org/research/collection_online/collection_object_details.aspx?objectId=466190&partId=1> [accessed June 20 2017]

²²¹ Xue interview (2017)

Western motifs. Therefore, even though Western blowing techniques had been brought to the Imperial Workshop, the cutting patterns were uniquely Chinese.

Even more radically, in terms of the development of Chinese glass appreciation, small transparent wares, notably snuff bottles, began to be mould-blown during the latter part of the Dynasty.²²² Many were painted on the inside to imitate traditional Chinese landscapes, calligraphy and other motifs [Figure 77], which is of particular interest to me as I explore the idea of ink, trapped inside glass, in an abstraction of brush and ink landscapes and calligraphy.²²³

Decorative glassmaking went into decline, though, after the death of the Qianlong Emperor in 1799, with the consequent loss of Imperial support,²²⁴ and was completely interrupted in the early twentieth century.

Many reasons have been suggested for this. I

believe it is due to the difficult political and economic

conditions at the time and the abdication of the last Qing (Manchu) emperor in 1912, when the new Republic of China was established, following 2,000 years of art-making under Imperial rule. Later in the twentieth century, fine, decorative glass and other wares were considered elitist and were banned or confiscated during Mao Zedong's Cultural Revolution (1949–1976), when Mao



Figure 77 Snuff bottle, Qing Dynasty, Yu Shuyun, inside-painted landscape with Grass script calligraphy and red chop, height 6cm.

Source: sothebys.com/en/auctions/catalogue/2013/bloch-vii-hk0495/lot.70 (2013) ©2018 Sotheby's

²²² In mould-blowing, a bubble of molten glass is lowered into a mould, or placed inside a two-part closed mould, and then further inflated to fill the mould. In this way, a full-size vessel, complete with elaborate decoration, can be made almost instantly. See: Corning Museum of Glass, *Mold Blowing*, nd <<http://www.cmog.org/video/mold-blowing>> [accessed 4 May 2017]

²²³ Dr. Guo Jianyong 郭建永 (also known as Jianyong Guo, in the West) has recently revived the Qing Dynasty practice of painting the inside of bottles, in the contemporary context. See Guo Jianyong, "Inside Painting", as Used for Chinese Snuff Bottles, Suggested as a New Model for Contemporary Glass Art' (PhD Thesis, University of Sunderland, 2016)

²²⁴ Xue (Shelly) Lü (2009), pp. 36–37

pronounced that art should serve the masses.²²⁵

Having disappeared from China for nearly a century, glassmaking skills were revived, once again, by imported Western 'studio glass' techniques in the early 2000s (in Mainland China). As during the Qing Dynasty, when glassmakers in the Imperial workshop adapted Western techniques to, over time, develop a uniquely Chinese aesthetic, it is expected that contemporary Chinese glassmakers will do so too.

4. Contemporary Context

a) *Introduction*

In the early 1960s, Harvey Littleton and others established the US Studio Glass movement and promoted glassblowing as a process for 'artistic expression' that could be practised at the level of the solo artist, rather than simply at an industrial one, requiring factories for production.²²⁶ Glass, as an expressive material, gained popularity and rapidly spread to Europe, Australia and Japan.²²⁷ The Studio Glass movement came to greater China, decades later, in the late 1980s, and to the Chinese mainland in 2000, where it has caught on quickly and is now being taught in 22 recently established university studios.

²²⁵ Mao Zedong, 'Talks at the Yanan Forum on Literature and Art', trans. by the Maoist Documentation Project, *Selected Works of Mao Tse-Tung*, 1942 <https://www.marxists.org/reference/archive/mao/selected-works/volume-3/mswv3_08.htm> [accessed 2 July 2017]. Although decorative wares would not have been produced during this time, China continued to make and export industrial glass. (Zhang Lin, 2014)

²²⁶ Scott Benefield, 'A Short History of the Studio Glass Movement', *Articles*, 2012 <http://www.scottbenefield.com/Scott_Benefield/Articles/Entries/2012/10/18_A_Short_History_of_the_Studio_Glass_MovementOriginally_published_in_Past_and_Present%2C_Peter_Layton_and_London_Glassblowing%2C_2012.html> [accessed 2 May 2017]

²²⁷ Ibid.

Dr. Xue (Shelly) Lü²²⁸ considers Qing glass to have been a renaissance in Chinese glassmaking.²²⁹ I believe, though, that Qing glass was merely the apex of some 2000 years of continuous glassmaking. The Qing propelled glass away from its status as a minor craft material and advanced its decorative and utilitarian potential, only to be interrupted for most of the twentieth century. Therefore, I believe the true renaissance in Chinese glassmaking began with the arrival of studio glassmaking. Not only did the movement revitalise the craft, it shifted glass away from its use as a decorative or utilitarian medium and began exploiting its expressive potential.

b) *The Chinese Studio Glass Movement*

In Taiwan, Loretta Hui-shan Yang, a multi-award-winning Taiwanese film star-turned glassmaker, was the first studio glass artist and, in Chinese tradition, ultimately chose lost wax and hot casting as her techniques. Along with her husband, the former eminent Taiwanese film director, Chang Yi, Yang co-founded Asia's first contemporary art glass studio, Liúli Gōngfāng,²³⁰ in 1987, in Taiwan.²³¹ Her body of lead crystal work references traditional Chinese motifs

²²⁸ Xue (Shelly) Lü was the first Chinese glassmaker to receive a PhD in the subject, with her thesis entitled 'The Investigation into the Development of Glass as an Expressive Medium in China through Direct Contact with Western Methods of Making, Decoration and Forming' (University of Wolverhampton, 2009). There are now six Chinese glassmakers who have completed their PhDs in the West, all in the UK. Source: Shi Dian 时典, 'An Investigation into Contemporary Chinese Glass Calligraphy through the Application of Metal Oxides in Studio Glass' (unpublished PhD Proposal, University of Sunderland, 2017)

²²⁹ Xue (Shelly) Lü, Wang Qin, and Xue (Shelly) Lü, eds., *Now/Then: Influences of Qing Dynasty Glass on Contemporary Glass Art* (Shanghai: Shanghai University Press, 2014), Exhibition Catalogue, p. 29

²³⁰ Liúli 琉璃 is an archaic word for crystal and gōng fāng (工坊) means factory. Yang chose the ancient word liúli over the more common word for glass, bōli (玻璃), because it evoked refinement and traditional culture, as does her art. See: CCTV, 'Loretta Yang: The Woman behind the Liuli Phenomenon' *CCTV.com*, 2007

<http://www.cctv.com/video/cultureexpress/2007/04/cultureexpress_128_20070417_7.shtml> [accessed 26 March 2017]>

²³¹ LLGF Corporation, 'Liuli', *Liuligongfang*, 2014 <<http://www.liuli.com/en-us/introduction.aspx>> [accessed 26 March 2017]

'like some form of historical inevitability'.²³² For commercial purposes, she follows Qing approaches, using Liuli Gōngfang factory workers to cast and carve translucent (sandblasted) traditional Chinese objects and motifs, such as dragons, raising a new awareness and appreciation of decorative glass.

In her more important work, though, she uses hybrid (hot and kiln cast) techniques to push the material further than had been done in the past: into the realm of transparency. In this more personal work, she exploits this important property of glass to create large, expressive and unique pieces, often depicting the Buddha [Figure 78], which she hot-casts and then encases in solid, cast glass, creating a 'world inside the piece'.²³³



Figure 78 *The Flower of Meditation Speaks the Truth of Dharma*, 2000, Loretta Hui-shan Yang, traditional Chinese references in transparent hot and kiln cast glass, with Liuli Gongfang chop in frame, 72x19x16cm. Source: liuli.com.cn/news/20th_dharma_speaks_sc

On the mainland, studio glassmaking began in 2000 with the establishment of the glass studio at Shanghai University. With the assistance of Andrew Brewerton, then Dean of the University of Wolverhampton Glass Department, Professor Zhuang Xiaowei (MA in Glass, University of Wolverhampton, 2000) brought Western glassmaking techniques to the University, with most of the equipment coming from other craft disciplines and having to be adapted to glassmaking: ceramics kilns, jade carving wheels and a drill press used in woodworking, for instance.

²³² Yang Boda, 'A New Milestone along the Chinese 'Glass Road'', in *Liuligongfang: Loretta Hui-Shan Yang Chinese Glass Art Creative Studio* (Beijing: Palace Museum, 1991)

²³³ Y-Jean Mun-Desalle, 'Pioneering Artists Loretta Yang And Steven Weinberg Push The Limits Of Contemporary Glass Art', *Forbes Lifestyle*, 2017 <<https://www.forbes.com/sites/yjeanmundelsalle/2017/04/01/pioneering-artists-loretta-yang-and-steven-weinberg-push-the-limits-of-contemporary-glass-art/#46b9677b3538>> [accessed 1 June 2017]>

That same year, the second Chinese glass studio was established at Tsinghua University in Beijing. It is now headed by Dr. Guan Donghai, who also obtained an MA in Glass from Wolverhampton (2003).²³⁴ Western glassmaking techniques and curricula were therefore brought to China, as they had been during the Qing Dynasty. The Chinese Studio Glass movement, though, began with Wolverhampton-trained Chinese glassmaker, teaching on home soil, rather than with foreigners, like the Jesuits, who came from abroad to teach during the Qing.

Graduates from these two, original university glass programmes, including some of my contemporaries from the early years at Shanghai University, have since established most other Chinese university-level programmes, disseminating the knowledge and casting techniques of notable Wolverhampton casting glassmaker, Keith Cummings, throughout China.²³⁵

Six years into the Chinese Studio Glass movement, Suzanne Frantz, former curator of twentieth-century glass at the Corning Museum of Glass, wrote that ‘there is [...] a sense of urgency to catch up and to grow – not only technically, but philosophically, too’.²³⁶

Frantz has been a long-standing supporter of the development of the Chinese Studio Glass movement. Her comment was, therefore, probably not intended as a criticism but rather a sentiment that applies to any art form that has been ‘imported’ from another culture. This can be seen, for example, in Blues music,

²³⁴ Guan Donghai later received a PhD from the University of Sunderland (2013).

²³⁵ At least 22 college-level glass art programmes have been established in China (including Hong Kong but not Taiwan) since 2005, indicating the popularity of this relatively new material as an expressive medium. See: Xue (Shelly) Lü, *Chinese University Glass Program: A Seed Growing with The Soil of China* (Potteries Museum, Stoke-on-Trent: New China Symposium: Ahead of the Curve, 17 April 2015), unpublished, p. 5, Xue (Shelly) Lü. Email to Sheila Labatt, ‘Chinese University Glass Programmes Update’, 13 March 2017 and Zhuang Xiaowei. Email to Sheila Labatt, ‘Chinese University Glass Programmes’, 5 April 2017

²³⁶ Suzanne K. Frantz, ‘Glass Tiger’, in *GlassRoutes: From Wolverhampton to China*, ed. by Stuart Garfoot (Wolverhampton, UK: University of Wolverhampton, 2008), p. 33

which is rooted in nineteenth-century southern US slavery songs (which themselves evolved from African spirituals) but was transposed to the American Midwest and other urban centres in the early to mid-twentieth century, where it slowly developed into uniquely regional variations.²³⁷



Figure 79 *Bowl*, 2007, František Vízner, cast and cut glass, Ø32cm. Source: frantisekvizner.com © 2010 František Vízner Collection

In the Blues, as in glass, one must first understand and master technique, which often involves imitation of the original, particularly in China where painting and calligraphy have always been taught by copying the masters. Wáng Xīzhī (303–361), for example, is the most cherished calligrapher of all time and ‘is to Chinese calligraphy as Michelangelo is to sculpture or Shakespeare to literature’.²³⁸ Yet none of his original work survives, and it is only known through masterful copies, which in turn are studied and copied.²³⁹

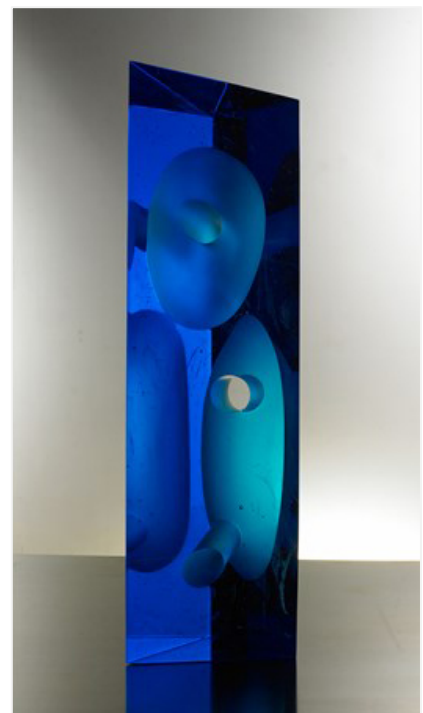

Figure 80 *Grey Flute Series: Sea Blue*, 2006, Zhuang Xiaowei, cast glass, inspired by minimalist, cast Czech glass, 63x18x17cm. Collection: National Museum of Scotland (V.2008.2)

As Frantz wrote, most early works, particularly in the Shanghai studio, were obviously inspired by Western cast glass. Zhuang Xiaowei, founder and head of the Shanghai University glass studio, has been inspired by the works of Libensky and Brychtova and other Czech cast glass artists [Figure 79] since he began casting glass [Figure 80].

²³⁷ Ed Kopp, ‘A Brief History of the Blues’, *All About Jazz*, 2005 <<https://www.allaboutjazz.com/a-brief-history-of-the-blues-by-ed-kopp.php>> [accessed 22 March 2017]

²³⁸ Ponte Ryūri, ‘Wizards of Ink: 王羲之 (Wáng Xīzhī, 303 – 361), Part I’, *Beyond Calligraphy*, 2011 <https://beyond-calligraphy.com/2011/12/01/woi-wang_xizhi-p1/> [accessed 1 July 2017]

²³⁹ Ibid.

Xue (Shelly) Lü has noted that Chinese glass students' work has tended to stylistically resemble that of their tutor. Zhuang's focus is on open mould, transparent and highly polished glass casting. His technique and inspiration by Western art movements have, in turn, been reflected in many of his students' work.²⁴⁰

Luo Xiaosu, for example, was one of Zhuang's early Shanghai University glass students and is now an instructor in the University's studio. He began his glass career creating a body of Western, Cubist-inspired work, writing his Master's dissertation on the subject in 2008 [Figure 81].²⁴¹



Figure 82 *A Study on the Space of Buddhist Statues*, 2016, Luo Xiaosu, inspired by the Buddhist caves at Dunhuang, dimensions unknown. Photo: courtesy of the artist

Now that his work has matured, Luo has moved away from Cubism and his work is now 'firmly anchored in Chinese culture and history', as Frantz had predicted would be the case with the early Chinese studio glassmakers.

Luo's recent work is inspired by Buddhism, and the caves at Dunhuang [Figure 82],²⁴² considered one of the greatest repositories of Buddhist art in the world,²⁴³ instilled in him an overwhelming sense of humility.²⁴⁴ In his diary, he also refers to 'light' radiating from the

Buddha statues, dating back to at least the fourth century AD, making glass an



Figure 81 *Dignity of Han Official*, 2008, Luo Xiaosu, Chinese historical reference rendered in Western, cubist aesthetic, 80x27x12cm. Photo: courtesy of the artist

²⁴⁰ Xue (Shelly) Lü (2009), p. 172

²⁴¹ Luo Xiaosu, 'Cubism Tendency in Contemporary Glass Art' (unpublished Masters Dissertation, Shanghai University, 2008)

²⁴² Designated a UNESCO World Heritage Site in 1987, the caves are also known as the 'Caves of a Thousand Buddhas'. They sit along the Silk Road on the edge of the Taklimakan Desert where traders would pray for safe passage across the desert.

²⁴³ Brook Larmer, 'Caves of Faith', *National Geographic Magazine, Online*, June 2010 <<http://ngm.nationalgeographic.com/print/2010/06/dunhuang-caves/larmer-text>> [accessed 22 May 2017]

²⁴⁴ Luo Xiaosu. Email to Sheila Labatt, 'Dunhuang Caves', 21 May 2017

excellent material for representing the radiance that was speaking to Luo from inside the caves.

When I visited the caves in 2003, I was struck by the poor condition of many statues and murals. They had suffered ‘almost every ailment’²⁴⁵ including harsh desert conditions, neglect, vandalism and pilfering by archaeologists from many countries, beginning, in 1907, with Aurel Stein, a Hungarian-born scholar working for the British Museum.²⁴⁶ In some cases, the caves therefore felt empty. Interestingly, Luo’s early Dunhuang Cave-inspired pieces are devoid of direct reference to Buddhist carving or painting, highlighting the dearth of figures inside many of the caves that I have seen.²⁴⁷

In Xue’s opinion, ‘more exciting progress’ was being made, in the early days, in the Tsinghua studio than in the Shanghai one²⁴⁸ because of the work created by the studio head and teacher at Tsinghua, Guan Donghai. Guan uses sand and lost wax casting techniques to create opaque or translucent pieces [Figure 83]. He consistently references Chinese motifs, issues and reflections on his Chinese heritage, which includes Mao’s Cultural Revolution. A similar sensibility was reflected in his students’ work, according to Xue.



Figure 83 *City Gate Series VII*, 2006, Guan Donghai, opaque and translucent cast glass, glass inspired by London’s preservation of old buildings and ancient Chinese architecture, 47x32 x13cm. Source: liuliart.cn/Photo/HTML/Photo_584

²⁴⁵ Attributed to Fan Jinshi in Larmer (2010)

²⁴⁶ Stein’s spoils are considered ‘one of the richest hauls in the history of archaeology’ and earned him a knighthood in England. Relics from the caves, located in museums around the world, are now the subject of repatriation calls from the Chinese government. Source: Fan Jinshi, ‘Master Plan for the Conservation and Management of the Mogao Grottoes: Preparation and Achievements’, in *Conservation of Ancient Sites on the Silk Road*, ed. by Neville Agnew, Symposium Proceedings (Los Angeles, USA: Getty Publications, 2010)

²⁴⁷ In Luo’s works in progress, he depicts a seated Buddha inside a similar style of ‘cave’.

²⁴⁸ Xue (Shelly) Lü (2009), p. 172

For example, having been struck by how well London's historic buildings have been preserved,²⁴⁹ Guan developed a greater appreciation for ancient Chinese architecture, and this was the impetus for his allegorical *City Gate* series. For these, he used rounded, strong-shouldered²⁵⁰ entrances to walled Chinese cities of the Han Dynasty (221 BC–AD 220) to evoke power and to address the propensity in contemporary China of destroying the old to make way for the new, particularly in architecture.

Guan's work is kiln or sand cast and is not usually polished, giving his pieces a matte finish, whose 'un-glassiness' disguises most properties of the material. Guan's work also combines opaque and translucent elements, often in figurative pieces but also in his *City Gate* series. These have been compared technically and aesthetically to David Reekie's

[Figure 84],²⁵¹ of which Jennifer Opie says 'the intrinsic beauty of glass holds little fascination [and that] the material must be pressed into the service of narrative and comment'.²⁵² He therefore does not 'glorify [glass] as a material'²⁵³ as was also the case in ancient Chinese glassmaking and is a tradition that Guan's work appears to be resurrecting.

Whatever the early aesthetic or inspiration in Chinese contemporary glass, the traditional preference for casting has carried on since ancient times as the



Figure 84 *Fruit of the Sea VII*, 2007, David Reekie, opaque and translucent cast glass, pâte de verre, enamel, the 'intrinsic beauty of glass holds little fascination' for him, 41x16x14cm. Source: caa.org.uk/exhibitions/archive/2008/myths-and-legends/david-reekie/

²⁴⁹ Guan Donghai, *Sand Cast and Kiln Glass: A Chinese Context* (Saarbrücken, De: Lap Lambert Academic Publishing, 2014), p. 22

²⁵⁰ *Ibid.*, p. 20

²⁵¹ Andrew Brewerton, 'Essay', in *GlassRoutes: From Wolverhampton to China*, ed. by Stuart Garfoot (Wolverhampton, UK: University of Wolverhampton, CADRE Publications, 2008), 11–19, pp. 14–15

²⁵² Jennifer Hawkins Opie, *Contemporary International Glass* (London: V&A Publications, 2004), p. 106

²⁵³ David Reekie, 'David Reekie', *Heart of England Glass*, nd <<http://heartofenglandglass.co.uk/group-members/david-reekie/>> [accessed 3 May 2017]

technique of choice, both in Taiwan and in mainland China. Many reasons have been given for this, not least the country's skilful mould-making and bronze casting traditions, as well as the amount of electricity (often in short supply) required to run a hot shop.²⁵⁴

Other reasons given for the Chinese preference for casting in the contemporary context refer to the Chinese temperament. Keith Cummings, for example, writes that casting 'is a matter of personality as much as anything'.²⁵⁵ Xue Lü elaborates on this by suggesting that the Chinese have the 'patience, persistence and equable temperament to keep a constant interest' during the long making process. She also believes that the 'introspective and quiet character of the Chinese is the opposite of the features' displayed by performance-based glassblowing in the West.²⁵⁶

Zhuang Xiaowei puts it slightly differently by generalising that the Chinese are traditionally more patient, due to their long tradition of craftsmanship in other materials, than Westerners, who seek the instant gratification that glassblowing and flameworking bring.²⁵⁷ This xenophobic viewpoint gives pause for thought because it ignores Western craft traditions. In addition, it does not consider today's fast-paced environment – the internet, travel, globalism – that raises expectations of a quick turnover in many endeavours, including in the Chinese context. Therefore, the 'patience' theory may not hold water in future, if at all.

Whatever the reasons for casting as the technique of choice in early contemporary glassmaking, the Chinese temperament was not the only reason that glassblowing was discounted in the early years of the Studio Glass movement.

Many years of practice is required to develop the skills necessary to blow glass

²⁵⁴ Frantz (2008), p. 32

²⁵⁵ Keith Cummings, *Techniques of Kiln-Formed Glass* (London : Philadelphia: A & C Black ; University of Pennsylvania Press, 2007), p. 10

²⁵⁶ Xue (Shelly) Lü (2009), p. 168

²⁵⁷ Zhuang Xiaowei interview with Sheila Labatt re: Chinese Studio Glass movement, Shanghai, 7 April, 2013

to an accomplished technical level, whereas casting techniques can be learned relatively quickly. Casting was therefore taught as an initial technique, allowing Chinese glassmakers to produce work straight away and to mature more quickly than if blowing had been the initial method of instruction.

In addition, Professor Xiao Tai, Head of Glass at Shanghai Polytechnic, admits that, although blowing and flameworking are now technically allowed in universities, progress within the art context has been slow, for two reasons: the first is a concern for student safety and the attendant 'loss of face' for the university should an accident occur.²⁵⁸ The other reason relates to a lack of funding for setting up and running hot shops.²⁵⁹ Only now are blowing and flameworking facilities, for expressive purposes, beginning to develop, with Tsinghua University and the China Academy of Art in Hangzhou having now set up hot shops.

Other programmes are approaching glassblowing from a different angle. Xiao Tai, for example, believes that studio artists and factories should collaborate closely because the origins of glassblowing are industrial. His plan for incorporating blowing into the Shanghai Polytechnic programme, therefore, is to begin cooperating with factories that can teach blowing courses and help create artwork for the students, and he reports that several other colleges are doing the same.²⁶⁰

As for casting, glassmakers like Luo Xiaosu in Shanghai [Figure 81 and Figure 82] and others have begun to develop a unique aesthetic, based on their rich cultural and aesthetic heritage. Although further progress will be made in the years to come, contemporary Chinese glass has already developed more quickly than the Imperial glass of the Qing Dynasty did, which took several hundred years to perfect a highly accomplished, Chinese style.

²⁵⁸ This argument surprises me because, in my experience, safety regulations are only lightly considered or enforced in many aspects of life, including activities in the glass studio.

²⁵⁹ Xiao Tai. Email to Sheila Labatt, 'Glassblowing in Chinese Universities', 25 February 2017

²⁶⁰ Xiao Tai (2017)

Indeed, in 2009, only four years after Frantz suggested that contemporary Chinese studio glass lacked originality, the Alexander Tutsek-Stiftung Foundation described the emerging movement as having *begun* to develop a uniquely Chinese aesthetic and narrative:

After several years of seeking and learning, in part by imitating Western models, artists have started to develop their own language. Original inventions are on the increase; the initial anonymity is starting to dissipate. Artists link and fuse the new from the West with their own national traditions and skills. Contents, message, and symbolism stand in the foreground; beauty and the particular qualities of the material glass receive little emphasis on the other hand. Some works address social problems with great sensitivity. They have a contemporary energy and are often anchored in Chinese cultural and historical traditions.²⁶¹

I too was part of the early Studio Glass movement and was included, as an honorary Chinese glass artist (a member of the 'Young Chinese Glass Family' [Figure 85]),²⁶² in exhibitions, publications and for national awards.²⁶³ I was taught the Western models of glass casting that Zhuang Xiaowei had imported to the Shanghai University studio from the University of Wolverhampton: open-mould casting producing highly polished work. I felt differently, though, about emulating Western art movements, as Zhuang [Figure 80], Luo [Figure 81] and others were doing in the early days.



Figure 85 'Young Chinese Glass Family', 2006, early Shanghai University glass studio-members on Sheila Labatt's rooftop in Xintiandi, Shanghai. Photo: Fraser Barton

²⁶¹ Alexander Tutsek-Stiftung, 'Glass.China', *Alexander Tutsek-Stiftung*, 2008 <<http://www.atutsek-stiftung.de/exposition-article/glass-china/?lang=en> > [accessed 11 March 2017]

²⁶² Xue (Shelly) Lü (2015), p. 8

²⁶³ See Appendix IV – CV, outlining my participation in the early Chinese Studio Glass Movement through Education (MA, 2010), Exhibitions, Awards and Publications.

As a foreigner, I was fascinated by all things Chinese and began early on to reference Chinese motifs, materials and social issues in my work. Of particular interest were the wooden armatures for the 'Long-Horn' Miao minority²⁶⁴ headdress [Figure 86 and Figure 87],²⁶⁵ the Great Wall of China, acupuncture needles, ink, the history of Chinese painting [Figure 88] and the decimation of traditional Shanghai *Shíkùmén* (石库门 'stone gated' laneway houses) to make way for modern construction, resulting in a rapid and irreversible loss of patrimony, [Figure 89].²⁶⁶



Figure 86 Preparation of Long Horn Miao headdress, consisting of a horn-shaped armature, ancestors' hair and yarn. Photo: Roberto Stocco



Figure 87 *Miao Mix*, 2006, Sheila Labatt, cast crystal with steel nails, Award of Excellence, Nanjing, 2007, 50x90x15 cm. Photo: Xiao Jin

²⁶⁴ The Miao are one of 55 ethnic (non-Han) Chinese minorities. The remote Long-Horn Miao (长角苗 *chángjiǎo miáo*), who have no written language, are a sub-group of the Miao/Hmong minority and have named themselves after the shape of the wooden, horn-like armature they use for their headdress. This enormous headdress consists of wool and ancestors' hair and can weigh up to four kilograms.

²⁶⁵ 'Award of Excellence' for *Miao Mix* at the Second Chinese Academy Exhibition of Modern Arts and Crafts, Nanjing Arts Institute, Nanjing, 5th–20th December, 2007

²⁶⁶ 'Academy Award' [sic] (Best in Show) for *New Shanghai II* at the Third Chinese Academy Exhibition of Modern Arts and Crafts, Shanghai, 15th–20th January, 2008



Figure 88 *The Long History of Chinese Ink Painting*, 2012, Sheila Labatt, cast crystal, 71x26x9 cm. Photo: Xiao Jin



Figure 89 *New Shanghai II*, 2007, Sheila Labatt, cast crystal, referencing Shanghai's unrelenting construction of skyscrapers, red chop reference in lower left corner, Academy Award (Best in Show), Shanghai, 2008, 38x10x10cm. Photo: Xiao Jin

My glass education in Shanghai pre-dates the emerging Chinese interest in glassblowing for artistic expression. Between 2005 and 2010, against the backdrop of my Chinese (via the University of Wolverhampton) casting education, and lacking the facilities and ability to blow glass, I grew frustrated with my inability to create the spontaneous work that can be achieved in glassblowing and flameworking. This could be due to my Western origins, as Xue (Shelly) Lü and Zhuang Xiaowei have suggested may be the case.

I therefore began to develop techniques for embedding 'apparently spontaneous' marks, inside solid crystal, that were inspired by my own brush and ink calligraphy, and that of others, to produce unique imagery in every piece.

These pieces, created by manipulating crystal in its liquid state, came to evoke ink wash in traditional landscape and were the impetus for the research into new techniques that form the core of this project, that create a sense of fluidity, gesture and unpredictability.

5. Artist Survey: Technical and Aesthetic Context

a) Introduction

The artists' work in this section provides a context for my research and situates my work technically, aesthetically and symbolically.

The first subsection reviews techniques in which bubbles and voids are used to create movement inside cast glass, to varying degrees. I examine the practice of artists in whose work bubbles displace glass and create a sense of fluidity and movement inside the casting, looking at them in order of magnitude of this movement. I begin with the work of Tom Patti, whose bubble creates little to no movement, and end with that of Willi Pistor, whose piece exhibits significant, apparently spontaneous, movement.

Next, I review the aesthetic context for my research, examining the work of glassmakers who investigate ink and/or painting in cast glass. I then note the work of others who have explored these subjects in blowing, coldworking and flameworking.

The section ends with my reflections on bubbles and movement, cross-cultural inspiration, spontaneity and wúwéi, white and the 'leaving blank' principle, language and communication, and dimensionality.

b) *Technical Context: Voids, Bubbles and Displacement*

American glassmaker, designer and material scientist Tom Patti uses bubbles to design controlled, geometric forms.²⁶⁷ His manipulation of scale and perception²⁶⁸ is highly personal because he is blind in one eye and says that he only needs one eye to see but both eyes for depth perception.²⁶⁹

In *Asahi Lumina with Bronze and Mirrorized Disk*, [Figure 90], Patti's bubble is the principal compositional element in a highly controlled, precise and symmetrical piece. He uses a single, proportionally large bubble, centred within a cuboid shape, evoking a sense of stability.

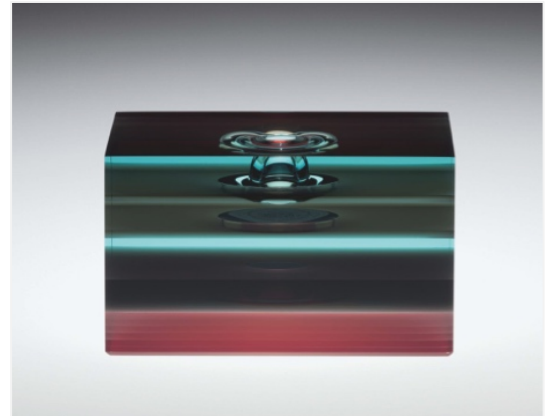

Figure 90 *Asahi Lumina with Bronze and Mirrorized Disk*, 1991–1993, Tom Patti, glass, highly-controlled and symmetrical bubble placement, centred inside a near-cube, symbol of stability and permanence, 9x16x12. Corning Museum of Glass (2007.4.187) Gift of the Ben W. Heineman Sr. Family

The bubble, that appears to have come to rest in a soft, black bed, created surprisingly little movement inside the object. Normally, a bubble of that size would have moved a significant distance because of its air volume. It would also have shown movement by dragging layers of colour with it. Patti used float glass though, which must be brought to an unusually high casting temperature

²⁶⁷ Corning Museum of Glass, *Tom Patti: Meet the Artist* (Corning, NY., 2008) <<http://www.cmog.org/event/meet-artist-tom-patti>> [accessed 4 April 2017]

²⁶⁸ Patti studied perception theory at the New School for Social Research in New York. See: Trapp, Kenneth R., and Howard Risatti, 'Skilled Work: American Craft in the Renwick Gallery', *National Museum of Art, Smithsonian Institution Press*, 1998

<http://americanart.si.edu/collections/search/artist/?id=3706> [accessed 3 May 2017]

²⁶⁹ Conroy, Sarah Booth, 'Artist in a Brave New Glass World', *The Washington Post*, 1980 <https://www.washingtonpost.com/archive/lifestyle/1980/05/04/artist-in-a-brave-new-glass-world/e1250c85-e1c1-4a4f-843f-81df72ac56fe/?utm_term=.eab35ee764bb> [accessed 4 May 2017]

to melt and move the bubble.²⁷⁰ Since his full technique remains confidential, I assume that he fired the piece at a low temperature, just hot enough to fuse the sheets of glass while not disturbing the bubble, which was probably in place prior to assemblage and fusing.

Like Patti, American studio glass pioneer and fellow sinophile Stephen Weinberg creates precision bubble work [Figure 91]. He explains that his control of bubble placement and consequent lack of immediacy are a reaction to 'a world that has spun out of control',²⁷¹ and that he finds peace in glassmaking.

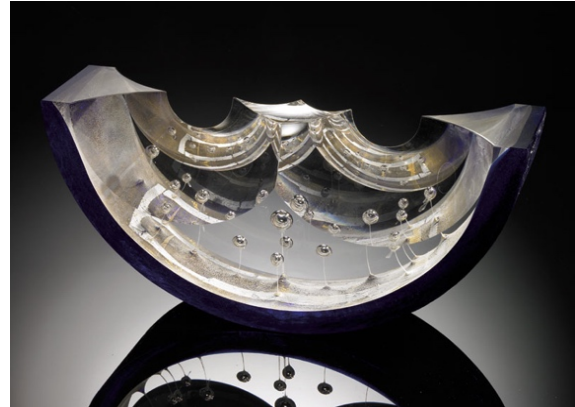

Figure 91 *Double C Boat*, from 1999–2003 series, Steven Weinberg, cast crystal, using precise bubble placement to delicately drag colour from the bottom, 17x36x9cm. Source: echtgallery.com/steven-weinberg/

In *Double C Boat*, he traps bubbles that become 'frozen' in time and space. Weinberg's bubbles are smaller than Patti's but, like Patti's, are centrally located and a fundamental compositional element in the piece. He positions them symmetrically and with precision inside pre-cut and drilled cast crystal, which melts more readily than float glass. As such, his bubbles travel further and create a visible trajectory, though they only slightly drag the whitish colour from the bottom. Still, compared to Patti's cool minimalism, the delicate, organic 'tails' in Weinberg's *Double C Boat* render a more expressive piece, in which the bubbles and tails are further highlighted by cut lenses and exceptionally clear crystal.

Danish artist Steffen Dam is another technically accomplished and perfectionist glassmaker. He embraces spontaneity and unexpected results. Dam creates organic inclusions – pre-formed in blown glass and then cast – that are inspired

²⁷⁰ Float glass, also known as window glass, is a sheet of flat, highly polished glass made by allowing liquid glass to solidify on a layer of molten metal, such as tin, and is mostly used in windows.

²⁷¹ Steven Weinberg, 'Steven Weinberg', *Holsten Galleries: Contemporary Glass Sculpture*, nd <<http://www.holstengalleries.com/steven-weinberg/>> [accessed 11 March 2017]

by natural science²⁷² and are juxtaposed with geometric forms inside which they appear to float.

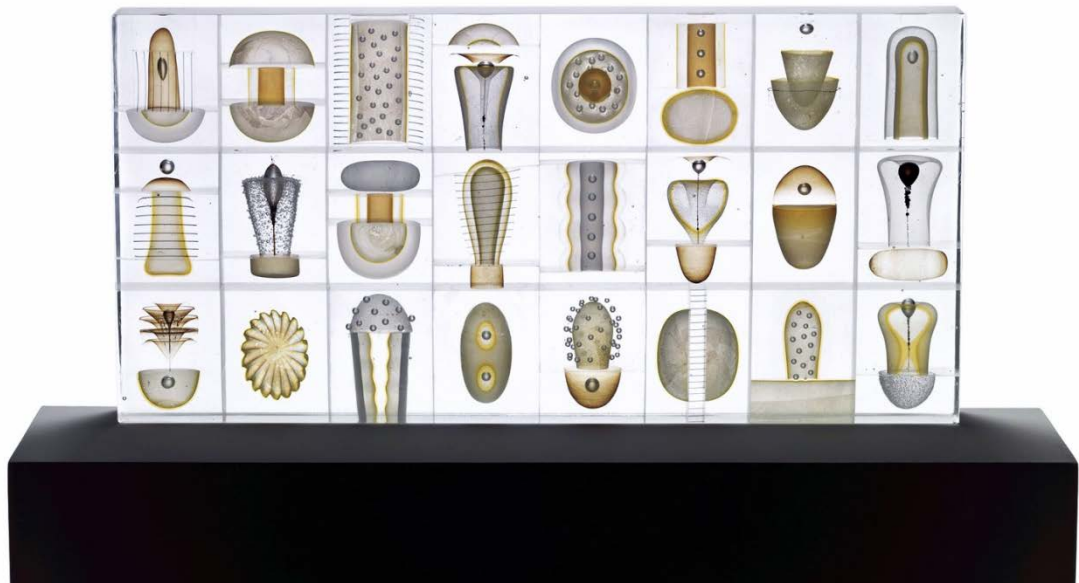

Figure 92 *Flower Block*, 2012, Steffen Dam, blown, cast and fused glass, static bubbles contrast with veiling displaced by bubble in lower left corner, 28x58cm. Collection: Corning Museum of Glass, 27th Rakow Commission (2012.3.36)

In *Flower Block* [Figure 92], as in Weinberg's and Patti's work, bubbles are key to the imagery and composition. They also display traits found in both artists' pieces: in 15 quadrants, the bubbles are intended to have been stationary and not to have distorted or otherwise acted upon the inclusions, as in Patti's *Asahi Lumina with Bronze and Mirrorized Disk* (where bubble movement appears negligible [Figure 90]). In the lower left element, though, the bubble's trajectory appears to have dragged, distorted and therefore delicately acted upon the dark yellow veiling, as the bubbles in Weinberg's *Double C Boat* [Figure 91] have also done.

Distinct from these artists, Antoine Leperlier, a French glassmaker with significant professional ties to China, uses bubbles to create organic, apparently spontaneous imagery, contained within a stiff geometric framework. The bubble

²⁷² Corning Museum of Glass, 'Biography: Steffen Dam', nd <<http://www.cmog.org/bio/steffen-dam>> [accessed 29 May 2017]

placement in *L'instant juste avant III* [Figure 93] occupies the centre of a cube, as does the bubble in Patti's *Asahi Lumina with Bronze and Mirrorized Disk* [Figure 90]. In Leperlier's, though, the bubble has travelled the length of the piece, creating expressive movement and a moment frozen in time and space. This different approach to bubble use is important in the context of this research into spontaneity.

Leperlier takes a philosophical view of glass movement, which he describes as a 'memory'. According to a 1999 interview, he also wrestles with ideas of present, past and melancholy in the face of time's relentless march,²⁷³ and, in his 2002 article *An Untimely Position*, characterises the bubble in *L'instant juste avant III* as a shadow of time and a metaphor for death and erotic desire.²⁷⁴

In this piece, movement and organicity are seen in the slumping around the top of the bubble, while the other sides remain strictly geometric.

The slumping is created as the bubble begins to rise, leaving behind a void which the molten glass then fills. This, in turn, causes a 'sinking' effect on the top surface, as predicted in Newton's third law of motion.²⁷⁵



Figure 93 *L'instant juste avant III*, 2002, Antoine Leperlier, cast glass, geometry bordering on organicity, 18x18x19cm. Source: antoine-leperlier.com, œuvres 2002

²⁷³ Lhôte, Jean-Marie, *Ambivalence of Past and Present: Interview with Antoine Leperlier*, 1999 <http://www.antoine-leperlier.com/medias/fichiers/ambivalence_of_past_and_present_english_text_pdf_88_ko.pdf> [accessed September 25 2017]

²⁷⁴ Leperlier, Antoine, *An Untimely Position* (Nancay, Fr.: Galerie Capazza, 2002), Exhibition Catalogue <http://www.antoine-leperlier.com/medias/fichiers/an_untimely_position_english_text_pdf_32_ko.pdf> [accessed 12 March 2017]

²⁷⁵ Newton's Third Law states: 'To every action there is always opposed an equal reaction: or the mutual actions of two bodies upon each other are always equal, and directed to contrary parts.' Source: Newton, Isaac, 'The Mathematical Principles of Natural Philosophy', trans. by Andrew Motte, 2015 <<https://ebooks.adelaide.edu.au/n/newton/isaac/mathematical-principles-of-natural-philosophy/index.html>> [accessed 5 October 2017]

More importantly, the transparency of the material ‘grants simultaneous access to the [exterior and] interior dimensions’²⁷⁶ and reveals the action of the bubble on Latin alphabet letters, causing a distortion. Here, the inclusions take on the shape of an hourglass, in which the narrowest part is where the bubble begins its travel upward, leaving behind a void that draws nearby elements inward.

The Latin letters used by Leperlier are distorted and random, making specific meaning elusive. The piece can only ‘evoke’ language, as would be the case if these had been unfamiliar Chinese characters. Each viewer will therefore interpret the work in their own, unique way.

Outside German glass circles, little is known about Willi Pistor. This untitled 1984 piece is worth noting because of its different aesthetic purpose for the bubble. In this piece, the encased organic and asymmetrical veiling, is the most important element of the composition [Figure 94] and was caused by the movement of this, and one other bubble that has ‘fired out’.²⁷⁷ The remaining bubble’s role is secondary, unlike those of Patti, Weinberg, Dam and Leperlier, which are integral to the composition. Like theirs, though, Pistor’s technique calls for the same balance of control and chance that is a key aspect of this research.

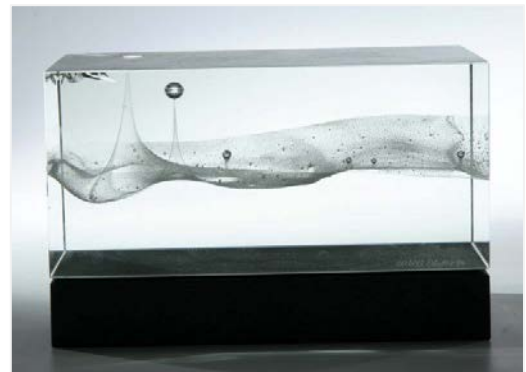

Figure 94 Untitled, 1984, Willi Pistor, optical glass, bubble movement produces organic and asymmetrical veiling, 13x21x13cm. Source: liveauctioneers.com/item/5373710_782-objekt-willi-pistor-glass-object-contemporary

c) *Aesthetic Context: Casting – Ink, Landscape and Calligraphy*

Shanghai-based glassmaker Dr. Xue (Shelly) Lü has long been interested in

²⁷⁶ Leperlier (2002)

²⁷⁷ This occurs when a bubble fails to remain trapped inside the glass, having travelled to the top of the piece and ruptured upon exiting.

‘echoing Chinese craft and culture’²⁷⁸ in glass, particularly brush and ink painting. To this end, she has created an extensive body of work that evokes abstract ‘ink’ painting. 凝霜7 (*Snow 7*) was inspired by the shadows of denuded ‘winter trees’²⁷⁹ and references ink generally, as a traditional material, rather than landscape or calligraphy [Figure 95].



Figure 95 凝霜7 (*Snow 7*), 2007, Xue (Shelly) Lü, pâte de verre, spontaneous-looking, abstract ‘ink’ marks, inspired by denuded trees, Ø16cm. Source: Two Cities Gallery, Shanghai, Foundation Spring Show exhibition catalogue



Figure 96 *Ink 15*, 2005, Xue (Shelly) Lü, centrifugally cast glass, fluid and spontaneous ink-like marks, Ø26. Photo: courtesy of the artist

She usually works in kiln-formed glass but has also had the opportunity to investigate ‘ink’ in centrifugally cast glass [Figure 96],²⁸⁰ an uncommon technique in art glass, during her time at the University of Wolverhampton. In this work, the uniformly saturated ‘ink’ marks *appear* spontaneous and fluid, whereas carefully controlled and ‘unspontaneous’ preparation of the black elements had, in fact, been necessary to achieve this loose and graceful aesthetic.

For both pieces, she began by fusing black Bullseye ‘talc’²⁸¹ at higher temperatures (900°) than are usually used in pâte de verre (760°–820°), so that the glass would not just fuse but also stretch and flow, leaving behind arbitrarily-

²⁷⁸ Xue (Shelly) Lü (2009), p. 9

²⁷⁹ Ibid., p. 208

²⁸⁰ Ibid., An industrial technique in which ‘the molten [liquid] glass takes shape inside rotating steel moulds under the effect of centrifugal force’. p. 159

²⁸¹ Talc is the finest available glass powder and, when fused, leaves behind a smooth surface, without the graininess that frit would produce.

placed holes and *apparently* freely-applied ink marks.²⁸² In the case of 凝霜7 (*Snow 7*), she applied and fused the 'disk' to a white pâte de verre ground, which was intended to evoke paper and the 'leaving blank' principle in Chinese painting.²⁸³ She also specified that white glass was an 'essential element' in depicting ink painting.²⁸⁴ In the centrifuge casting, though, she used the black disc with clear, molten glass as a ground.

Professor Zhuang Xiaowei is particularly inspired by Czech glass, which informs the bulk of his work and can be seen in his monochrome *Grey Flute Series: Sea Blue* [Figure 80].²⁸⁵ Still, he occasionally creates 'ink' pieces, as in *Poetics of the Handmade* [Figure 97]. This elegant form was inspired by China's symbol of modernisation, the Shanghai World Financial Centre.²⁸⁶

The piece exhibits a loose, splashy, abstract expressionistic 'ink' application, embedded in an otherwise disciplined geometric form – this juxtaposition makes for a strong piece. Like Xue, his approach is to evoke ink generally, as a traditional Chinese medium, rather than to illustrate or evoke specific ink applications such as landscape or calligraphy. His process, though, is far simpler than Lü's pâte de verre 凝霜7 (*Snow 7*) [Figure 95], which required three firings (including a carefully designed fused component) to complete.²⁸⁷ Zhuang needed only one open-mould firing, and freely scattered the glass powder into the bottom of the mould prior to filling it with clear billets and firing.



Figure 97 *Poetics of the Handmade II*, 2011, Zhuang Xiaowei, cast glass, spontaneous 'ink' application, 90x19x15cm. Source: litvak.com/external-gallery/750

²⁸² Xue (Shelly) Lü (2009), pp. 160-1

²⁸³ See Chapter III – Ink > Colour and Chops

²⁸⁴ Xue (Shelly) Lü (2009), p. 159

²⁸⁵ Zhuang Xiaowei. Email to Sheila Labatt, 5 April 2017

²⁸⁶ Designed by New York-based architect, William Pederson, and opened in 2008.

Karen LaMonte is a renowned American artist who is recognised for her 'Dress Impressions': cast monumental, milky translucent glass sculptures of drapery-clad female forms [Figure 4]. She has also begun exploring 'ink', in bas relief cast glass that evokes drapery [Figure 98].



Figure 98 *Ink in Water Drapery Study*, 2008, Karen LaMonte, bas relief cast glass, evokes liquid ink,, 60x92x7cm. Source: karenlamonte.com

As she does with her dress pieces, she focuses on creating soft, flowing fabrics. Like Xue's [Figure 95 and Figure 96] and Zhuang's [Figure 97] works, *Ink in Water Drapery Study* evokes liquid ink as a medium rather than as specific painted ink imagery, such as calligraphy or landscape painting.

Shanghai-based glassmaker Xiao Tai has practised traditional ink painting, calligraphy and chop carving since childhood, although he eventually majored in Western oil painting at East China Normal University. Still, while painting in Western media, his work was inspired by Chinese ink painting. As he says, 'the spirit of ink has permeated in [sic] my blood'.²⁸⁸ Ink also continues to influence his glasswork, sometimes broadly and minimally [Figure 99] and sometimes more representationally, as in his series of abstracted Chinese landscapes [Figure 100].



Figure 99 *The Plate Series 2*, 盘器系列, 2008, Xiao Tai, cast glass, oblique reference to ink painting, Ø32x5cm. Photo courtesy of the artist



Figure 100 *Landscape Series 1* 山水之, 2013, Xiao Tai, fused and slumped glass, abstract traditional Chinese landscape with traditional colours, 25x18x2cm. Source: taiglass.org, Landscape Series

²⁸⁷ Xue (Shelly) Lü (2009), p. 156

²⁸⁸ Xiao Tai. Email to Sheila Labatt, 25 February 2017

Like Xue (Shelly) Lü, Wang Qin has extensively explored the idea of ‘glass as ink’. Unlike Xue, though, he focuses expressly on contemporary calligraphy [Figure 101] and landscape [Figure 103, Figure 104, Figure 105 and Figure 107].

Wang Qin’s *Non-Calligraphy* series [Figure 101], whose title derives from the Buddhist Diamond Sutra text, that addresses the opposing concepts of *dharma* and *non-dharma*,²⁸⁹ evokes contemporary calligraphy in a style similar to that of contemporary brush and ink calligrapher Yang Xiaojian’s *Happy Mover* [Figure 102]. In Yang’s painting, a heavy application of fully saturated black ‘ink’ was drawn using broad, heavy brushstrokes, executed on the floor with a large brush to fill more of the positive picture space than traditional calligraphy would have done.²⁹⁰



Figure 101 *Non-Calligraphy XVI*, 2008, Wang Qin, cast glass, evokes contemporary brush and ink calligraphy, 91x52x6.5cm. Source: wangqinstudio.com, Non-Calligraphy Series

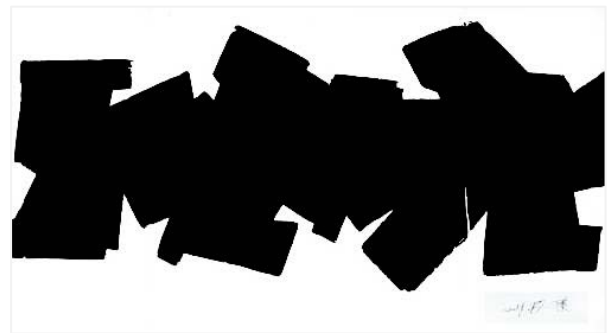

Figure 102 *Happy Mover*, 2008, Yang Xiaojian, ink on paper, contemporary brush and ink calligraphy, 150x90cm. Collection: Sheila Labatt

²⁸⁹ Wang Qin. Email to Sheila Labatt, ‘Non-Calligraphy Series’, 27 February 2017. An 868AD copy of the Diamond Sutra was discovered in the Dunhuang Caves that are also the inspiration for Luo Xiaosu’s recent work [Figure 82]. The 16-foot long scroll is the ‘world’s earliest complete survival of a dated printed book’, dating nearly six centuries before the Gutenberg Bible. It is housed at the British Library.

²⁹⁰ It is common nowadays for contemporary Chinese painters to work on the floor, as the Abstract Expressionists had done, whereas even large-scale, traditional calligraphy and landscapes would have been painted on a table because of the smaller, intricate nature of the strokes.

Although Wang Qin's *Zen Mountain II* [Figure 103] is a highly-abstracted, minimalist landscape piece, he has juxtaposed the contemporary with the traditional by mounting it in an antique, wooden Chinese frame. The work similarly evokes the heavily applied ink on paper so prevalent in contemporary Chinese calligraphy. *Zen Mountain II* differs from calligraphy, though, in that the pale, traditional *grue* 'horizon', making use of the golden mean two thirds of the way up, creates a sense of lightness in the piece and a more restful aspect than the vigour of the contemporary calligraphy 'brush strokes' in *Non-Calligraphy XVI* [Figure 101], while still strong and embodying a sense of *qi*.



Figure 103 *Zen Mountain II*, 2010, Wang Qin, cast glass and antique wooden frame, evokes contemporary ink landscape painting in a traditional frame, 33x58x18cm. Source: wangqinstudio.com, Zen Mountain Series



Figure 104 *Late Spring*, 2008, Wang Qin, cast glass, abstracted, traditional Chinese landscape demonstrating classical methods for representing depth of field, 91x52x6.5cm. Source: wangqinstudio.com, Distant Mountains Series

More concrete than *Zen Mountain II* [Figure 103], *Late Spring* [Figure 104] not only evokes mountains in landscape painting, it also illustrates classical methods for representing depth of field in Chinese brush painting through overlapping elements, in greater and lesser degrees of sharpness.

In *Zen Mountain IV*, Wang Qin has created a sense of scale and the sublime in small works. Not only do these black and white pieces exhibit powerful references to ink and paper, Wang Qin has also juxtaposed the

impression of vast plains against tiny versions of the iconic, sheer karst mountains that are famously depicted on the reverse of China's ¥20 note [Figure 105 and Figure 106].²⁹¹

The imagery in *Zen Mountain IV* evokes the sublime, which Joseph Addison viewed as observable in 'open champaign country, a vast uncultivated desert, of huge heaps of mountains [with] high rocks and

precipices...', particularly when seen in the context of the 'largeness of a whole view, considered as one piece'. This is the case, even in a relatively small work.²⁹² In the words of Alberto

Giacometti, 'by doing something a half centimetre high, you are more likely to get a sense of the universe than if you try to do the whole sky'.²⁹³

Zen Mountain III [Figure 107] also

demonstrates sublimity, in highly saturated black 'ink', by using the extreme format and relative scale of Chinese landscape scrolls, with high-ratio dimensions of 99.5x11x3cm.²⁹⁴ The piece is an example of Addison's further view that sublimity exists in works that depict a 'rude kind of magnificence',²⁹⁵ by suggesting the vastness of nature and, by extension, the 'infinity, mystery



Figure 105 *Zen Mountain IV*, 2011, Wang Qin, cast glass, scale of iconic Chinese karst mountains evokes the sublime vastness of nature, three-dimensionally, 45x32x6cm each. Source: wangqinstudio.com, Zen Mountain Series



Figure 106 Yangshuo's karst mountains as depicted on the ¥20 note and reproduced in miniature in *Zen Mountain IV*

²⁹¹ These dramatic, vertical mountains are located along the Li River between Guilin and Yangshuo, Guangxi Province, and have become a major tourist attraction in the last 20 years.

²⁹² Joseph Addison, 'Pleasures of Imagination', *Papers from The Spectator*, 1712 <<http://philosophy.lander.edu/intro/articles/addisonart-a.pdf>> [accessed 5 October 2017]

²⁹³ Quoted on a wall panel at the 'Giacometti' exhibition, Tate Modern, May 10 – September 10, 2017

²⁹⁴ A good example of a large ratio painting can be seen in one of China's most important landscapes, *Along the River During the Qingming Festival* (清明上河图) by Zhang Zeduan (1085–1145), which measures 26cmx5.25m.

²⁹⁵ Addison (1712)

and terror' of the universe, as Marjorie Hope Nicolson has described it.²⁹⁶

Flux et Fixe XXVIII [Figure 108] is a reference to the duality of time – that which 'passes v. that which man arrests in matter, to exorcise the wounds from his undeviating arrow'.²⁹⁷

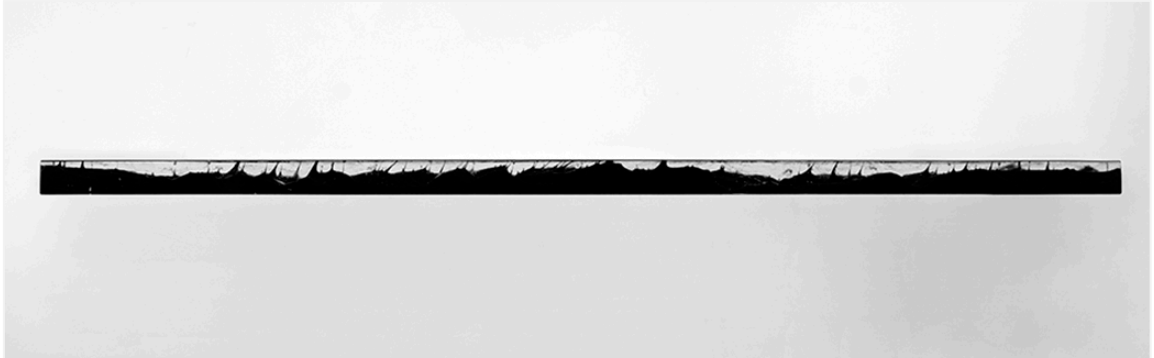

Figure 107 *Zen Mountain III*, 2010, Wang Qin, cast crystal, high-ratio dimensions of 99.5x11x3cm evoke the sublimity of nature and the universe and the scale and format of Chinese landscape scrolls. Source: wangqinstudio.com, Zen Mountain Series

In this piece, he renders spattered liquid 'ink' generally, without specifically evoking landscape, calligraphy or other painting subjects. He has also used colours associated with Chinese painting: black for ink, white for paper and red for the chop.

In *Flux et Fixe XXVIII*, black enamel was used to create a loose, gestural 'ink' surface decoration. The enamel was fused between two sheets of clear glass, which were then placed in the bottom of the mould. The rest of the glass and the pâte de verre and ceramic



Figure 108 *Flux et Fixe XXVIII*, 2013, Antoine Leperlier, cast glass, pâte de verre and ceramic, using Chinese colours, evokes spattered Chinese 'ink' with a red chop on a white background, as paper, 30x30x9cm. Source: antoine-leperlier.com, œuvres 2013

²⁹⁶ Marjorie Hope Nicolson, *Mountain Gloom and Mountain Glory: The Development of the Aesthetics of the Infinite*, Weyerhaeuser Environmental Classics (Seattle: University of Washington Press, 1997), p. 323

²⁹⁷ My translation of 'le temps qui passe et celui que l'homme fige dans la matière pour exorciser les blessures de son invariable flèche' in Thierry de Beaumont, 'Antoine Leperlier : Clartés Cosmiques', *Revue de La Céramique et Du Verre*, March – April 2017 <http://www.antoine-leperlier.com/medias/fichiers/donner_sa_chance_au_hasard.pdf> [accessed 25 June 2017]

inclusions were then added and the whole was fired.²⁹⁸ This allowed the splashed 'ink' to appear as a surface application and to remain sharp after casting. Leperlier explains that the apparent motion of the dripping 'ink' and the red inclusion, which 'begins to flow', are like 'frozen instants in glass' and represent 'duration'. The 'white core with the black cube' reference 'language', the 'stability of memories' and the halting of time.²⁹⁹

Chair et Os XXIX [Figure 109] refers to flesh and bone, but the series was inspired by the cosmos and nebulae, observed through the Hubble telescope.³⁰⁰ The universe expresses Leperlier's constant concerns about time, life and death. As in *Flux et Fixe*, he discusses the piece in terms of dualities: the 'impossible synthesis'³⁰¹ of flesh and bone and the nature of glass itself – at once a solid and a liquid.³⁰²

The inclusion of pâte de verre and ceramic elements also evokes Chinese landscape paintings.³⁰³ Tall, sheer mountains with three



Figure 109 *Chair et Os XXIX*, 2016, Antoine Leperlier, cast glass, evokes brush and ink wash and tall, sheer Chinese landscape mountains, 27x27x10cm. Source: antoineleperlier.com, œuvres 2016

²⁹⁸ A comprehensive analysis of the difficulties of combining ceramic and hot glass can be found in Jessamy Kelly, 'The Combination of Glass and Ceramics as a Means of Artistic Expression in Studio Practice' (PhD Thesis, University of Sunderland, 2009)

²⁹⁹ Antoine Leperlier. Email to Sheila Labatt, 14 June 2017

³⁰⁰ de Beaumont

³⁰¹ Antoine Leperlier and Manuel Fadat, *Conversation avec Antoine Leperlier in Corps de Verre: Musée du Verre de Carmaux*, 2011 <http://www.antoine-leperlier.com/medias/fichiers/entretien_avec_manuel_fadat.pdf%20%5Baccessed%20October%2024%202017%5D> [accessed 24 October 2017] Exhibition Catalogue

³⁰² de Beaumont

³⁰³ As an honorary professor at the Shanghai Institute of Visual arts, Leperlier is knowledgeable about Chinese art. However, the reference to brush and ink landscape in *Chair et Os XXIX* was unintentional, as can be deduced from the other works in the series, which do not evoke Chinese landscape painting motifs.

rounded summits are expressed here with a fluidity and expressive immediacy not usually seen in cast glass.



Figure 110 *Shanghai Opener*, 2012, Guillaume and Sophie LePenher, cast glass and yew wood, Shanghai World Financial Centre form, symbol of modern Shanghai, 109x12x12cm. Source: <http://www.behance.net/lepenher>

Chinese culture also inspires collaborating French glassmakers, Guillaume and Sophie LePenher. They first visited China in 2009 and were captivated by its 'traditional culture as well as the strong energy of big cities like Shanghai'.³⁰⁴

The LePenhers have returned every year since 2009 and report that traditional Chinese culture has changed many things in their life and creativity. Chinese gardens are of particular interest to the LePenhers, which has led them to incorporate personally-harvested wood in many of their pieces.³⁰⁵ These evoke ink and calligraphy in both traditional and contemporary motifs [Figure 110 and Figure 111].³⁰⁶

As Zhuang has done in *Poetics of the Handmade* [Figure 97], the LePenhers have recreated one of the most iconic symbols of modern China, the Shanghai World Financial Centre [Figure 110]. This glassy

skyscraper was intended to become a 'global magnet', pointing towards a 'brighter tomorrow' for Shanghai and 'the world as a whole'.³⁰⁷

Although Zhuang's piece omits the building's trapezoidal cutout near the top, it is shown in the LePenhers' glass and wood version, titled *Shanghai Opener*, a

³⁰⁴ Guillaume LePenher. iMessage to Sheila Labatt, 3 January 2017

³⁰⁵ They are also involved in the movement to eliminate trafficking of Chinese ebony. Guillaume LePenher. iMessage to Sheila Labatt, 29 April 2017

³⁰⁶ Guillaume LePenher. iMessage to Sheila Labatt, 3 January 2017

³⁰⁷ Mori Building China (Shanghai) Co., Ltd., 'Shanghai World Financial Centre: A Global Magnet', 2008 <http://swfc-shanghai.com/pdf/swfc_project_brochure_en.pdf%20> [accessed 11 April 2017]

reference to 'the Bottle Opener', as the building is affectionately known. In addition to depicting a contemporary motif, the LePenhers have also used traditional black 'ink' and 'Chinese red' inclusions, completing the allusion to modern China.



Figure 111 *Passage #1*, 2012, Guillaume and Sophie LePenher, yew wood and cast glass, mirror-image seal script characters, 51x34x11cm. Source: www.behance.net/lepenher

The LePenhers are also interested in Chinese calligraphy, as can be seen in their rendering of the ancient Seal

script [Figure 111]. For this, they flameworked Bullseye stringers to create *Chinese red* characters. Using a method similar to that of Leperlier in *Flux et Fixe* [Figure 108], they fused the stringers to sheet glass and cast them to become the front surface of the piece.³⁰⁸

d) *Aesthetic Context: Non-casting Techniques – Ink and Calligraphy*

The following pieces were made using techniques other than casting, such as blowing, coldworking and flameworking. In each case, they help contextualise and define the aesthetic aims of this research.

Tobias Møhl, for instance, evokes ink by embedding highly-saturated, threadlike lines in blown glass, using 'Venetian technique in a Scandinavian way' [Figure 112].³⁰⁹ Although it is Scandinavian in form, *Oval Blacknet #1* also evokes Chinese ink and the Song Dynasty cloud motif that is still widely used [Figure 113].³¹⁰

³⁰⁸ LePenher, 3 January, 2017

³⁰⁹ Møhl, Tobias, 'Tobias Møhl', *Taste: Contemporary Craft*, 2015
<<http://www.tastecontemporarycraft.com/tobias-mohl/>> [accessed July 15 2017]

³¹⁰ Song Dynasty (960–1279) court-style landscape painters used this stylised cloud motif which, over time, has grown more graphic. It is now used as a symbol of good luck throughout Northeast Asia in many craft, design and



Figure 112 *Oval Blacknet #1*, 2006, Tobias Møhl, blown glass showing spontaneous and gestural threadlike 'ink' lines, evoking Asian cloud motif, approx. dimensions 23x37x14cm. Collection: Corning Museum of Glass (2006.3.65)



Figure 113 Northeast Asian cloud motif. Source: pngtree.com/freepng/clouds-decorative-figure_619698.html

For her PhD research, Sunny Wang, a Taiwanese artist based in Hong Kong, investigated glassblowing and calligraphy in the context of Buddhism.³¹¹ Unlike Møhl's non-specific rendering of 'ink', Wang places particular emphasis on meaning in abstract (yet still legible) calligraphy in blown and cut vessels.



Red Happiness [Figure 114], for example, depicts an abstraction of the Standard script character for 'double happiness', 囍 (*shuāngxǐ*),³¹² and also demonstrates a bold use of Chinese red (vermilion).

Figure 114 *Red Happiness*, 2005, Sunny Wang, blown and cut glass, abstracted character for 'double happiness' 囍, 27x23x19cm. Source: <http://www.statesofillumination.com/dr-sunny-wang/>

manufacturing fields, such as clothing, porcelain, bronze and jewellery. It also appears in Western chinoiserie designs.

³¹¹ Sunny Wang 王鈴蓁, 'The Art of Be/Coming Through Glass: The Exploration of Studio Glass Art Inspired by Chinese Calligraphy and Framed by Buddhist Practice' (PhD Thesis, University of South Australia, 2012)

³¹² The character for double happiness is actually a ligature of two 喜 characters, also meaning happiness, that are compressed into the prescribed notional square [See Chapter III – Ink > Line > Chinese Calligraphy > Standard Script (Kǎishū 楷书)]. It is associated with love, happiness and luck and is used in many contexts, including wedding celebrations, for example. It is even the name of a popular brand of cigarettes.

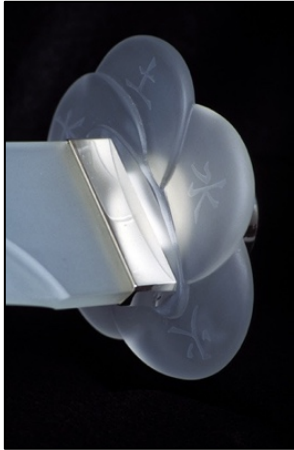

Figure 115 *5 Element Guard*, 2002, Anthony Scala, cast and coldworked glass, Chinese sword guard (detail), depicting the five elements in Chinese philosophy, rendered in accurate, unabstracted standard script characters. Source: [anthonyscalaglass.co.uk/Glass Swords](http://anthonyscalaglass.co.uk/Glass%20Swords)

In *5 Element Guard* Anthony Scala also uses Standard script calligraphy [Figure 115]. In contrast to Wang's abstracted double happiness character 囍, though, Scala has precision-sandblasted perfectly-executed characters, unaltered by heat or abstraction and displaying no spontaneity. As in Wang's *Red Happiness* [Figure 114], semantics are important. Scala's characters are easily legible in all Chinese dialects, as well as in Japanese and Korean, as wood (木 mù), earth (土 tǔ), water (水 shuǐ) and fire (火 huǒ).³¹³

Finally, Ayako Tani's PhD research investigated calligraphy in flameworking.³¹⁴

In sharp contrast to Scala's literal Standard script, Ayako

Tani translates fluid Japanese Eموji script/Hitofudegak calligraphy³¹⁵ into a floating three-dimensional, flameworked abstraction of the Japanese syllables for the word 'ghost' (ゆうれい *yu-u-re-i*) [Figure 116]. She compares the rhythmic spontaneity of brush and ink calligraphy to that of flameworking, in which the 'writing' can be executed in a matter of seconds.



Figure 116 *Ghost*, 2010, Ayako Tani, flameworked borosilicate, floating, three-dimensional Grass script-like calligraphy, H: 14cm. Source: ayakotani.co.uk.

³¹³ The piece was commissioned for the 25th anniversary celebrations of a kung-fu club and these characters represent four of the five elements in Chinese philosophy – the wǔ xíng 五行 – that are associated with all relationships in the universe, including the martial arts. (The obscured character in the image is 金 *jīn*, metal.) Other associations with the five elements include fengshui, cosmology, astrology (Chinese Zodiac), dynastic traditions, music (the pentatonic scale), tea ceremony and, most importantly, Chinese medicine.

³¹⁴ Ayako Tani, 'Multi-Dimensional Line-Drawing with Glass through a Development of Lampworking' (PhD Thesis, University of Sunderland, 2014)

³¹⁵ A 'one stroke sketch'. See: 'Hitofudegaki', Jisho <<http://jisho.org/word/一筆書き#>> [accessed 1 November 2017]

To create her calligraphy, drawn ‘in the air’, she varies her working speed and rhythm for different parts of the characters³¹⁶ – more quickly for thinner parts and more slowly for thicker ones – as if she were writing with brush and ink on paper.³¹⁷ The speed with which she executes her characters, only six times more slowly than if she had drawn them in ink,³¹⁸ allows her the immediacy with which to replicate a gestural, Grass script-like character that demonstrates ‘spontaneity of action’ within the Japanese aesthetics philosophy of shibusa.³¹⁹

Like Chua Boon Kee’s forged stainless steel sculpture, 《饮水思源》 *Flowing*, the architectural-scale work in London’s Chinatown seen in Figure 71, *Ghost* is fully rendered in the third dimension, within my definition. Both pieces comprise multiple characters or syllables,³²⁰ connected into a single, abstract, flowing element. They emphasise gesture and spontaneity – characteristics of both Japanese Hitofudegak and Chinese Grass script calligraphy, in which the brush is seldom lifted from the page.³²¹

e) *Discussion*

This analysis of the artists and works I have surveyed above occupies a separate section (rather than being included within the artist survey itself) because the discussion compares those artists’ work in relation to each other’s as well as to my own, and it does so in six independent contexts: bubbles and movement, cross-cultural inspiration, spontaneity and shibusa, white and the ‘leaving blank’ principle, language and communication and dimensionality.

³¹⁶The Japanese ‘alphabet’ is composed of syllables, variously called letters, characters and digraphs. For simplicity, I use the term ‘character’.

³¹⁷ Tani, p. 229

³¹⁸ Ibid., p. 230

³¹⁹ See Chapter II – Casting, Spontaneity and Flow > Spontaneity and Flow: Elusive Immediacy in Cast Glass > Spontaneity of Effect, shibusa (渋さ) and wúwéi (无为).

³²⁰ The word for ghost is written in four ordinary, syllabic Japanese Hiragano characters as ゆうれい (yu-u-re-i) and the abstracted version of *Ghost* is based on Japanese Emoji script, a Hitofudegak-style of calligraphy. (Ayako Tani. Email to Sheila Labatt, ‘Japanese Calligraphy Styles’, 19 April 2017)

³²¹ See Chapter III – Ink > Line > Chinese Calligraphy > Grass Script (Cǎoshū 草书)

(i) *Bubbles, Voids and Movement*

The pieces discussed here, that use bubbles to displace molten glass, are presented in order of least to most apparent movement. Comparing them helps contextualise the nature and level of affect I am seeking from voids on molten glass.

Tom Patti, whose *Asahi Lumina with Bronze and Mirrorized Disk* [Figure 90] shows no discernible bubble movement, uses precise and symmetrical bubble placement, which is antithetical to the apparent spontaneity of movement I am seeking. Weinberg, too, situates bubbles with controlled precision at evenly spaced intervals in *Double C Boat*, but builds in slight traces of bubble movement [Figure 91]. In *Flower Block* [Figure 92], Dam's bubbles behave in a combination of Patti's and Weinberg's approaches, within the same piece. Only the bubble in the lower left of the piece appears to have moved the veiling around it and those in the rest of the blocks appear not to have moved at all.

Patti, Weinberg and Dam, therefore, include nearly stationary bubbles as key compositional elements, whereas I, in contrast, use bubbles and voids to move and distort veiling or inclusions. I regard trapped bubbles as secondary (though not undesirable) to the spontaneous, fluid and asymmetrical traces of 'ink painting' they have left behind. This can be seen both in my early pieces, created when I was developing a language for my work [Figure 117], and in those that comprise the culmination of this research.³²²



Figure 117 *Updraft Murmuration*, 2012, Sheila Labatt, cast crystal, bubbles displacing molten glass to cause movement in veiling, 34x21x8cm. Photo: Xiao Jin

³²² See Chapter VI – Results

Leperlier's organic imagery in *L'instant juste avant III* is more dynamic and expressive [Figure 93]. Similarly, my piece, entitled 沪 (hù) [Figure 118],³²³ trapped a single, large bubble that sits on the cusp of firing out.³²⁴ Most importantly, and in contrast to the works of Patti, Weinberg and Dam, the bubble in *L'instant juste avant III* and in 沪 (hu) create a greater sense of animation, spontaneity and imminent danger, both inside the piece and on the top surface, where the glass has slumped around the bubble.



Figure 118 沪 (hù), 2008, Sheila Labatt, cast crystal, the moment before the bubble fires out of the block, 16.5x11x11cm. Photo: Xiao Jin

Finally, Pistor uses bubbles to entirely different effect [Figure 94]. His bubbles (originally, there were two) render the greatest sense of gesture and spontaneity, among the pieces reviewed in this section. In my opinion, the bubble that remains inside the piece carries less compositional value than the wave-like image left behind in the veiling. The movement and apparent fluidity in Pistor's piece is the most technically consistent with my aim of moving colour, represented in the form of ink-like imagery, that comprises the bulk of this research.

(ii) *Cross-cultural Inspiration*

As a non-native glassmaker in Shanghai, I was heavily inspired by Chinese fine art. To me, it seemed natural for one to create art in response to new surroundings. This survey of other artists' work suggests, however, that this is not always the case.³²⁵

³²³ 沪 (hù) is a less commonly-used word for Shanghai.

³²⁴ Firing out occurs when a bubble travels to the top of the piece and ruptures upon exiting, rather than remaining trapped inside the piece.

³²⁵ A comprehensive study of cross-cultural approaches to glassmaking is outside the scope of this project but a thorough discussion, in the context of flameworking, can be found in Peng Yi's 彭怡 (also known as Yi Peng and Pearl, in the West) 'Cross Cultural Lampworking for Glass Art: The Integration,

One can be inspired either by the exotic, as Zhuang and I were, or by one's heritage, as Guan and Xue were. Zhuang, for instance, learned glassmaking as a foreign student at Wolverhampton University and made work inspired by Western art forms – Czech glass, in particular [Figure 80]. I, as a Canadian, learned glassmaking in China and was similarly inspired by my adopted surroundings and art traditions. Zhuang and I continue to emulate adopted art traditions.

Guan [Figure 83] and Xue [Figure 95 and Figure 96], on the other hand, began developing their Chinese-inspired body of work while studying glass abroad, like Zhuang, at Wolverhampton University. Working in a culturally-alien environment prompted them to draw inspiration from their own tradition, and even their earliest work showed a strong sense of their cultural heritage. For this reason, Frantz was probably not referring to Guan or Xue when she remarked on the urgent need for early Chinese glass artists to 'catch up and to grow technically and philosophically'.³²⁶

(iii) *Spontaneity and shibusu (渋さ)*

In addition to being primarily inspired by Czech cast glass,³²⁷ Zhuang also addresses ink in *Poetics of the Handmade* [Figure 97]. Like Xue, in 凝霜 7 (*Snow 7*) [Figure 95], he evokes liquid ink generally, rather than in a specific painting context, such as calligraphy or landscape. The difference is that Xue's piece is carefully planned, over multiple firings, to evoke spontaneity through 'ink' as a loose, fluid medium. Zhuang, on the other hand, freely sprinkled glass powder into the bottom of his mould before charging it with clear glass billets and firing. In this sense, Xue's (and my) pieces demonstrate shibusu's 'spontaneity of effect' (apparent spontaneity) because, although their ink imagery reads as spontaneously executed, the pieces were in fact meticulously

Development and Demonstration of Chinese and Western Lampworking Approaches, Materials and Techniques for Creative Use' (PhD Thesis, University of Sunderland, 2014)

³²⁶ Frantz, 'Glass Tiger', p. 33

³²⁷ Zhuang Xiaowei. Email to Sheila Labatt, 5 April 2017

planned.³²⁸

Like Zhuang, Leperlier also achieves a spontaneous sense of ink in *Flux et Fixe XXVIII* [Figure 108]. Just as Zhuang had freely introduced black glass powder into the mould, Leperlier splattered (and fused) liquid enamel onto glass sheets prior to casting. I believe their techniques are as close to genuine spontaneity, or shibusu's 'spontaneity of action', as one can achieve in cast glass because of the direct and immediate connection between the artist's hand and the resultant mark-making.

LaMonte also expresses liquid ink in a general sense in *Ink and Water Drapery Study* [Figure 98]. The 'ink' in the piece is encased within cast glass, as it is in my work, with the difference being that the apparent fluidity of LaMonte's 'ink' results from the external form of the piece – drapery. In my work, the element of flow exists only inside the glass and is entirely generated by the movement of molten glass. Unlike the movement in LaMonte's 'drapery', my forms juxtapose the apparent spontaneity of ink-like inclusions with the work's geometry.

This contextual survey concludes by juxtaposing two pieces that sit furthest apart on the spectrum of spontaneity: Scala's *5 Element Sword Guard* [Figure 115] and Tani's *Ghost* [Figure 116]. They each faithfully emulate their respective calligraphy styles: Scala in rigid Standard script, and Tani in a Japanese version of Grass script – Emoji script/Hitofudegak calligraphy.

Ghost is especially important in the context of my research. Tani does not use voids to move glass inside a casting, as I do, yet her work evokes the same aesthetic. Her abstract, frameworked Japanese characters ゆうれい illustrate the gesture of quickly-executed calligraphy and illustrate rhythm, varied brush pressure and long, tapering lines. In particular, *Ghost*'s delicate 'spontaneity of action' exhibits a sensibility and immediacy that is always available to frameworkers and hot sculptors. In casting, this effect can only be achieved

³²⁸ See Chapter II – Casting, Spontaneity and Flow > Spontaneity and Flow: Elusive Immediacy in Cast Glass > Spontaneity of Effect, shibusu (渋さ) and wúwéi (无为)

when inclusions are set up to flow and distort, independent of the maker's hand, in a sort of controlled chaos, like the non-linear chain reactions described by the 'butterfly effect'.³²⁹

(iv) *White and the 'Leaving Blank' Principle*

Xue (Shelly) Lü specifies that a white ground is essential when depicting ink painting on paper in glass, as she did in her *pâte de verre* 凝霜 7 (*Snow 7*) [Figure 95].³³⁰ Similarly, Xiao Tai sandblasts an otherwise clear glass 'background' to evoke paper in *The Plate Series 2* [Figure 99].

In Xue's centrifuged *Ink 15* [Figure 96], though, she effectively captures an impression of ink on paper against a transparent ground. Similarly, Wang Qin's [Figure 101, Figure 103, Figure 104 and Figure 107], Leperlier's [Figure 108 and Figure 109] and Møhl's [Figure 112] pieces depict ink painting on transparent grounds. While viewing their work through to a white backdrop might enhance the graphic nature of their imagery, I believe a white ground is not 'essential' to evoking paper, as Xue has suggested. In fact, a clear glass ground is a subtler way to address the 'leaving blank' principle in Chinese painting.³³¹

In this project, brush and ink-like inclusions cannot be viewed in any way other than through transparent glass. I believe that my finished pieces pay tribute to the 'leaving blank' principle and are no less 'inky' for their transparent rather than white ground.

³²⁹ See Chapter II, – Casting, Spontaneity and Flow > Spontaneity and Flow: Elusive Immediacy in Cast Glass > Spontaneity and Flow: A Working Definition

³³⁰ Xue (2009), p. 159

³³¹ See Chapter III – Ink > Colour and Chops

(v) *Language and Communication*

In *L'instant juste avant III* [Figure 93], Leperlier's Latin characters evoke language, though they are intentionally meaningless. After the firing process, they remained legible and the work clearly suggests language and communication, to be interpreted as one sees fit. With 𠄎 [Figure 118], I had intended to generate an inclusion that would evoke similarly meaningless, yet clearly abstract, calligraphy after firing.

To create the piece, I carved the character 𠄎 [Figure 118] deeply into a slab of glass, filled the depression with saturated fine black glass powder (with the intention that it would read as ink) and assembled clear slabs above and below the carved one to trap the colour during firing.³³² In the final piece, the character had become overly distorted (possibly due to too high a casting temperature) and beyond legibility. I reserve judgment, therefore, as to whether the piece evokes language or communication in the way that Leperlier's does, if at all.

Passage #1 [Figure 111] reflects the LePenhers' interest in Chinese characters, particularly those written in ancient Seal script.³³³ For this piece, they selected three characters based strictly on aesthetic appeal.³³⁴ Meaning was irrelevant.³³⁵ They flameworked and fused these characters onto sheet glass, which they then placed at the bottom of a mould, prior to loading the rest of the glass and firing. This technique ultimately situated the characters on the front surface of the work.

Seal script is difficult to read, even for native readers of Standard script, and the

³³² See Chapter V – Techniques Explored in this Project

³³³ Seal script was used as far back as the latter half of the 1st millennium BC and is traditionally used to carve chops (seals), hence the name.

³³⁴ Guillaume LePenher. iMessage to Sheila Labatt, 19 April 2017

³³⁵ 正(zhèng), lower right, means 'normal' or 'correct' and 命(mìng), upper right, means 'life'. The left-hand character is ambiguous and is either 而(ér), which has many meanings, or the character for sky or God, 天(tiān, as in Tiān'ānmén 天安门, literally, God Peace Gate).

LePenhers do not read it either. As a result, they inadvertently reversed the characters inside the mould, causing the characters to be backwards in the final piece. This rendered them even more illegible.

The LePenhers did not deliberately distort or create faux characters that would cause ‘shared illiteracy’ between Western and Chinese audiences, in the way that Xu Bing did in *Book from the Sky* [Figure 15]. The piece might, however, elicit a similarly hostile response from audiences who consider it an ‘abuse of language’, particularly since the piece was created by Westerners.

Their error is a sign of the times. Many Westerners are captivated by the beauty of Chinese characters and use them for design purposes. Inadvertently, they sometimes choose misguided or inauspicious ones. They also make errors in writing the characters, resulting in different, sometimes inappropriate, words.³³⁶ This is a particular problem with tattoos, where such mistakes are often seen. Even more widespread is the Northeast Asian propensity for rendering English text inaccurately on all manner of commercial objects, sometimes to humorous or naughty effect.

Still, *Passage #1* [Figure 111] evokes communication in the same way that ancient Egyptian hieroglyphs would, even if they were drawn backwards. In my work, I do not attempt to replicate Chinese writing at all in inclusions, only the characteristics of Grass script, while still evoking the vague sense of communication that can be seen in *Passage #1*. As in Cy Twombly’s paintings [Figure 25], the calligraphy evoked in the inclusions is liberated from ‘semantic baggage’, retaining only ‘gesture and movement’.

Unlike the LePenhers’ *Passage #1* [Figure 111], in which legibility was irrelevant to them, Scala selected five characters specifically for their meaning in Chinese philosophy. Like Scala, Leperlier selected correctly-executed and legible (Latin) characters for *L’instant juste avant III* [Figure 93] but, like the LePenhers, he

³³⁶ A missing or extra dot or a slightly longer line is all it takes to get into trouble. For example, the character for scholar 士 (shì) can easily be mistaken for 土 (tǔ) – dirt.

used them randomly, to elicit nonsense in that they do not form words, as they would if they were Chinese characters³³⁷.

Additionally, unlike the LePenhers' and Leperlier's characters, which merely *suggest* language and communication, Scala's are widely understood, as individual words and as a group, in Chinese philosophy [Figure 115]. For this reason, the piece holds little mystery and is therefore less engaging than works in which the characters are abstracted, whether slightly, as in Wang's *Red Happiness* [Figure 114], or entirely, as in Tani's *Ghost* [Figure 116].

The characters in *Ghost* are based on a highly abstract Japanese script and are further altered by moving from the second into a third, floating, 'mass-less' dimension.³³⁸ They are therefore nearly undecipherable. Still, they are based on real characters and therefore easily evoke written language in East Asia. The aim in this research project is for my inclusions to comprise the same cursive characteristics that inform Tani's work and to evoke language, albeit more obliquely than in *Ghost*.

(vi) Dimensionality

Glass, as an otherwise three-dimensional sculpting material, does not determine its dimensionality for the purposes of evoking ink painting in this project. It can be two-dimensional, just as paper can be three-dimensional.

Blown glass, for instance, is three-dimensional, as can be determined through touch. Its surface, however, is not. As is the case with *Writing IX Temple Jar* [Figure 61], Møhl's *Oval Blacknet #1* [Figure 112] and Wang's *Red Happiness* [Figure 114], blown glass can notionally be rolled out into a flat plane. The imagery in those pieces is therefore two-dimensional, and only sits on a three-dimensional object.

³³⁷ Unlike Latin letters, Chinese characters each carry their own significance, so the order of their assembly can be irrelevant in conveying meaning.

³³⁸ Ayako Tani, 'Ghost', *Ayako Tani Glass Art*, 2010

<<http://www.ayakotani.co.uk/works/ghost.html> > [accessed 3 March 2017]

Paper, on the other hand, is considered two-dimensional. It is rendered three-dimensional, though, in Mia Pearlman's *Inrush* paper installation [Figure 119], which evokes the same traditional cloud motif seen in Møhl's *Oval Blacknet #1* [Figure 112]. The installation is three-dimensional both within my definition, developed in Chapter III, and as can be determined by touch.



Figure 119 *Inrush*, 2010, Mia Pearlman, paper, ink and clips, the third dimension represented in traditionally two-dimensional medium, 488x152x122cm. Source: miapearlman.com

Assessing the dimensionality of inclusions is also problematic. To be considered three-dimensional, the inclusions must exhibit depth by being readable from all sides, as a series of receding two-dimensional picture planes, and not from any angle as segments of a unidimensional line, however thick.³³⁹ They cannot, therefore, read as extrusions.

One can determine the dimensionality of Wang Qin's forms, in the ordinary way, through touch.³⁴⁰ Regardless of the external dimensions of the work [Figure 101, Figure 103, Figure 104 and Figure 107], though, the embedded ink-like imagery in fact amounts to thick extrusions of two-dimensional picture planes. In the way that Indiana's *LOVE* is two-dimensional [Figure 55], so too are Wang Qin's pieces (*Zen Mountain IV* excepted [Figure 105]).

In glass terms, Wang Qin's inclusions can also be compared to *murrine*, which are extrusions of a fused image, embedded inside solid glass that has been stretched into cane.³⁴¹

³³⁹ See Chapter III – Ink > Ink and the Third Dimension > The Third Dimension Problem in Art

³⁴⁰ See Chapter III – Ink > Ink and the Third Dimension > The Third Dimension Problem in Art

³⁴¹ Owen Johnson, 'Glass, Pattern, and Translation: A Practical Exploration of Decorative Idiom and Material Mistranslation Using Glass Murrine' (PhD Thesis, Royal College of Art, 2015), p. 33 and *Glass Masters Series: Loren Stump [at*



Figure 120 *Murrine Rubik's Cube*, 2010, Robin Culbertson, fused and stretched glass, the design remains unchanged throughout the entire length of the hexagonal cane, as is revealed when the cane is sliced.

Source:
<https://i.pinimg.com/564x/f9/14/2d/f9142df595fd6d27647cfa4a06f24f5a.jpg>

The image runs the length of the cane and the design is revealed to be nearly identical from beginning to end once 'sliced' into sections [Figure 120]. If Wang Qin's pieces could be thinly-sliced, they, too, would reveal nearly identical images across all slices. This means that they do not represent a series of unique receding planes, as required by my definition of the third dimension.

Finally, presentation can affect dimensionality.

Tani's *Ghost*, as it is photographed in Figure 116, is three-dimensional. She usually displays it, though, by gluing it between two panes of glass that are held together by a picture frame, to enhance the sense of the calligraphy 'floating' [Figure 121].³⁴² She finds that framing it is less 'distracting' than displaying it suspended with fishing line, with which I disagree.³⁴³ Framing the piece constrains it, whereas suspending it emphasises pure form, clean brushwork and dynamic and unfettered calligraphy.³⁴⁴



Figure 121 *Ghost*, 2010, Ayako Tani, frameworked borosilicate glass, with wood frame that constrains the calligraphy and brings the work into the second-dimension, 15x21x4cm. Source: ayakotani.co.uk

8:20 Minutes] (Salem Community College NJ, 2007)

<<https://www.youtube.com/watch?v=NRTxXub6piE>> [accessed 1 June 2017]

³⁴² Tani explains that the back of the object was glued to one glass sheet and was covered on the front by another. The two sheets were held together in a frame. In addition to aesthetic concerns, this also protected the calligraphy from dust. Tani (2014), p. 228

³⁴³ Ibid.

³⁴⁴ I voice my disagreement having only seen photos of *Ghost*, framed and unframed. Perhaps the fishing line is indeed distracting when the piece is viewed in person.

Whether the piece shows better framed or not, the presentation choice itself is important in the context of dimensionality. Framing the otherwise three-dimensional *Ghost* brings it into the second dimension. Once it has been framed, the piece can only be viewed from the front and the back, like Wang Qin's framed *Zen Mountain II* [Figure 103],³⁴⁵ and cannot be seen from the sides, top or bottom. In my cast pieces, the transparent, three-dimensional object itself constitutes an invisible 'frame' that does not constrain or alter the dimensionality of the inclusions. It allows them to be read from all angles, as distinct, receding picture planes.

6. Summary

From antiquity, casting was the preferred technique in Chinese glassmaking, when the material was primarily used to imitate jade. Blowing was not explored in any depth until the mid-seventeenth century, during the Qing Dynasty, when glassmaking reached its zenith. The craft was completely interrupted in the early twentieth century, coinciding with the overthrow of the Qing Dynasty.

Glass, as an expressive medium, was only revived in mainland China in 2000, with the advent of the Chinese Studio Glass movement. Following tradition, casting was the technique of instruction in the two original university glass programmes and is now being taught in some 20 others.

As one of the early Chinese studio glassmakers I was also taught casting, which remains my technique of choice. For the purpose of this research into spontaneity in the casting process, though, my work is supplemented by hot shop and flameworked elements.

My early work, using bubbles, launched an enduring fascination with the use of their power to affect molten glass. In my first test piece, *Huang Shan* (Yellow Mountain) [Figure 1], bubbles moved the colourless veiling and fired out,

³⁴⁵ Which is also two-dimensional by virtue of its image being an extrusion.

leaving behind only milky traces of their existence. The image created by bubble displacing the veiling evokes traditional, painted representations of Huang Shan.

Having created 'mountain' imagery, I then explored ways to evoke the 'water' element of 'mountain/water' (the Chinese word for landscape) and discovered that trapped bubbles would be particularly well suited to this purpose. Not only can they move glass inclusions to create ink-like effects, they also read as water when trapped inside the glass.

In this chapter, I survey artists who use bubbles and voids, in a balance of control and chance, in terms of their technical and aesthetic purposes, to contextualise my research. I discuss them in order, moving through works in which stationary bubbles are primary compositional elements, to artists who use increasingly dynamic bubbles that can distort inclusions.

I also survey the work of glassmakers who imbue their cast pieces with a sense of 'inkiness', either generally or in landscape and calligraphy more specifically. Where relevant, I also cite a certain glass artists working in blowing, coldworking and flameworking.

The chapter concludes with a discussion of these artists' work in relation to the technical and aesthetic objectives of this project.

V TECHNIQUES EXPLORED IN THIS PROJECT

1. Introduction

I begin this chapter with a brief explanation of the glass choices I have made for this project, including the relevant properties of each brand or type.

To evoke apparently spontaneous 'ink' imagery inside cast glass requires that colour be manipulated inside the glass. Introducing the colour into the glass in the first place has formed a large part of this research. Methods include trapping colour between layers of glass and hot casting with colour inclusions, described below.

I then discuss techniques for manipulating the inclusions (the trapped colour) using voids and bubbles to displace the glass, during hot or kiln casting, and yield loose, gestural marks that evoke brush and ink line or wash.

2. Choice of Glass

I have chosen different types and brands of glass according to purpose, techniques used, size of objects and compatibility.³⁴⁶

I conducted over 40 tests, using voids, to examine flow patterns and inclusion distortion. These were small-scale, cuboid, precision tests for which components made in the hot shop would have been too large and irregular to produce meaningful data. I therefore chose Bullseye soda-lime glass because

³⁴⁶ Each brand uses proprietary glass 'recipes'. Different ingredients cause glasses to expand and contract at different rates and are said to have different Coefficients of (thermal) Expansion (COE). The COE is given as a number that represents its contraction or expansion in 10,000s of an inch over a set temperature range. Only glasses with the same or very similar COEs are said to be compatible. If incompatible glasses are fused together, the resulting object will crack or break, sometimes violently, even years later.

it is available in standardised sizes and is compatible across its colour range. It also fires according to Bullseye's recommended schedules, making the tests easy to plan, construct, record and replicate.³⁴⁷

For these tests, I fused coloured stringers³⁴⁸ to 60x60x6mm Tekta,³⁴⁹ in grid-like or other geometric patterns, so that the glass flow could be easily read by the distortion of otherwise regular lines. My analysis of these tests allowed me to loosely predict flow and inclusion behaviour inside larger forms.

For larger pieces, I used Glasma 705 furnace batch (blowing) glass, which is affordable and easily available, making it suitable for use in research tests. It can be used to hot cast bespoke billets and is compatible with coloured Gaffer and Kugler Colours, which, combined with layers of Glasma to form cane, were the basis for line inclusions.³⁵⁰ For these reasons, Glasma glass was used in all stages of the multi-technique making processes that included hot shop and kiln work within the same piece.

For a small number of pieces, I cast lead crystal to compare its optics with those of cast furnace glass.³⁵¹ For these trials, kiln casting was the only hot technique

³⁴⁷ Bullseye (COE 90) glass is incompatible with other commercially-manufactured glass brands.

³⁴⁸ Stringers are thin rods or 'threads' of glass, available in 0.5mm to 2mm in diameter, within the Bullseye range.

³⁴⁹ Clear sheets of Bullseye glass that come in 3mm to 6mm thicknesses.

³⁵⁰ Glasma was formulated to be 'as flexible as possible in fitting a wide range of colors', including Kugler Colors® and Gaffer™, both COE 96. See: William Glasner, 'Glasma 705...Specifically for the Hot Glass Studio Market...', *Studio Glass Batch LLC*, 2003 <<https://www.studioglassbatch.com/Glasma-batch.html>> [accessed 27 July 2017]

³⁵¹ Several years ago, I found a large amount of lead crystal – of unknown origin – behind a rural Chinese glass factory, for whom I was designing retail gift items. The crystal was no longer being used at the factory and I was able to buy it inexpensively. Unfortunately, nobody at the factory remembered its annealing range so I tested the material for months before I could safely work with it. The testing mostly involved cutting cast samples with a diamond saw. Improperly annealed crystal either shattered or did not produce clean cuts, due to thermal stresses in the glass. Final casting and annealing schedules suggested that the crystal was of a high lead content, probably as high as 35%, based on properties such as its low viscosity at comparatively low temperatures, and its optics, once polished.



Figure 122 Untitled, 2016, Sheila Labatt, kiln cast Glastma and Gaffer glass, veiling that partially obscures the 'ink' lines, Ø15x8cm. Photo: Sylvain Deleu

used. No colour-and-Glastma cane inclusions could be used because they would have been incompatible with the crystal.³⁵² Instead, Kugler Colours powder alone was used, to create ink-like wash effects.³⁵³



Figure 123 Untitled, 2016, Sheila Labatt, kiln cast Glastma and Gaffer glass, appealing veiling in contexts other than this research, 20x13x10cm. Photo: Sylvain Deleu

Lead crystal is exceptionally clear (showing little veiling and no cording),³⁵⁴ has a high index of refraction (allowing colour to 'pop' and bubbles to 'sing') and is softer than soda-lime glass (making it easier to coldwork but quicker to scratch). Unfortunately, it is also expensive, making it unsuitable for extensive research testing.

³⁵² This limited the types of inclusions that could be used, such as flameworked cane, to create calligraphic lines. Only powders could be used, to evoke wash and landscape. These techniques are explained below.

³⁵³ Although Kugler Colors® is a soda-lime glass, no compatibility issues arose because of the powder's negligible percentage within the overall mass of the lead crystal.

³⁵⁴ Cording is a visible deficiency seen in blown or hot cast objects, where subtle lines of clear glass, that have a slightly different coefficient of expansion from the rest, refract light at different rates. See: 'Chord' [sic], *Hot Glass Dictionary: Glassworking Terms*, 2009 <<http://www.glassblowers.org/hotglasdictionary.htm1>> [accessed 15 June 2017]

Although Glasma is nearly as clear as crystal when blown, it is not formulated for casting. When it is cast, cut, reassembled and recast, for example, it leaves behind significant veiling. This is problematic in the context of my research because it detracts from and can even obscure the inclusions [Figure 122]. It can, though, be appealing in other contexts [Figure 123].³⁵⁵

Furnace glass also melts at higher temperatures than crystal and has a higher viscosity. This makes flow and apparently spontaneous imagery more difficult to achieve. I nevertheless established firing schedules that would produce sufficient flow, within the capacity of the refractory moulds I was using.

A final note on glass choice concerns colour. Ink comes in many colours, including blue. Black is therefore not essential for representing ink. Still, I prefer my work to evoke black Chinese ink wherever possible.

Glass is different from soot-based ink, though, in that it is not truly black. It is composed of oxides that produce such deep blues and purples that it only *appears* black when it is dense enough. When it is used sparingly, though, its base colour becomes visible.³⁵⁶

The type of glass and the casting temperature can also affect the colour in thin applications of black powder. For instance, Gaffer transparent black powder turns purple when picked up and hot cast as a 30mm-thick billet [Figure 124].³⁵⁷



Figure 124 Bespoke, hot cast billet, 6x6x3cm, using 'black' Gaffer transparent powder that turned purple due to thin application of colour. Photo: Sheila Labatt

³⁵⁵ The veiling in Figure 122 (see Appendix V, Test #111) and Figure 123 (see Appendix V, Test #114) is particularly prominent because the pieces were photographed against a black background. When objects are shot on a white ground, the 'ink' becomes more prominent than the veiling, depending on its placement and prevalence. The only way to assess the true impact of veiling is to examine the object in person.

³⁵⁶ These remarks are based on my experience while researching this project and are not meant to be an exhaustive review of the issue.

³⁵⁷ Rolling a hot gather of clear glass over coloured glass powder on the marver, which adheres to the hot glass.



Figure 125 *Wash IV* (detail), 2016, Sheila Labatt, kiln cast Glastma and Gaffer glass, 'purple' billets like the one depicted in in Figure 124 turned blue, post firing, in an ink-wash effect, Ø15x20cm
Photo: Sylvain Deleu



Figure 126 Good greyscale using Bullseye stringer and powder eggshells on Tekta, 60x60x6mm Photo: Sheila Labatt

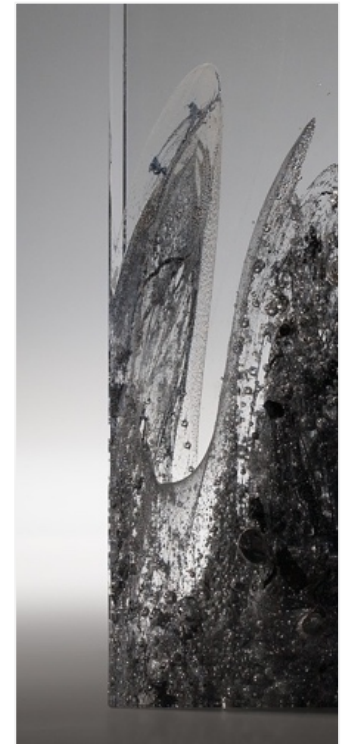

Figure 127 *Krakatoa* (detail), 2013, Sheila Labatt, cast crystal, Kugler Colours powder, rendering full spectrum of black to light grey 'ink' washes, 27x19x8cm. Photo: Xiao Jin

When the object in Figure 124 is subsequently kiln cast to around 890°, the powder inclusion turns blue [Figure 125].³⁵⁸ In these circumstances, therefore, Gaffer black powder cannot replicate the black through grey tonality range that is possible with Chinese ink washes.

Bullseye black, on the other hand, yields the full gradation of 'greyness' when fired at 820° [Figure 126].³⁵⁹ Kugler Colours powders also retain a black to grey spectrum when cast in lead crystal at 830° [Figure 127].³⁶⁰

In summary, although Bullseye black yielded the best gradations of grey, this was not the appropriate glass to use, other than for small flow tests, because it could not be gathered from the furnace, to make custom billets and cane. Kugler Colours remained on a black through grey spectrum when cast with lead crystal, which would have been too expensive to use for testing and is not used

³⁵⁸ See also Appendix V, Test #3

³⁵⁹ See Appendix V, Test #77

³⁶⁰ See Appendix V, Test #17

in university hot shops, for health and safety reasons, in any event.³⁶¹ Using Kugler Colours with Glasma produced an undesirable metallic sheen in cane inclusions. I also could not find a red in the Kugler Colours range that would yield Chinese red. I therefore used mostly Gaffer colours and Glasma blowing glass, despite their tendency to render ink wash in blue.

3. Introducing Colour into the Glass

a) *Trapping Colour between Glass Slabs*

One method I use for trapping colour inside cast glass is to make an initial cast of a transparent glass block, without inclusions. Next, I cut it into slabs under running water, using a diamond saw.³⁶² I then apply a thin layer of glass powder to the slabs [Figure 128]. For this, I suspend highly saturated colour in a rice gluten solution to lightly bind the powder and to prevent the design from altering while I am working. More importantly, the suspension prevents glass

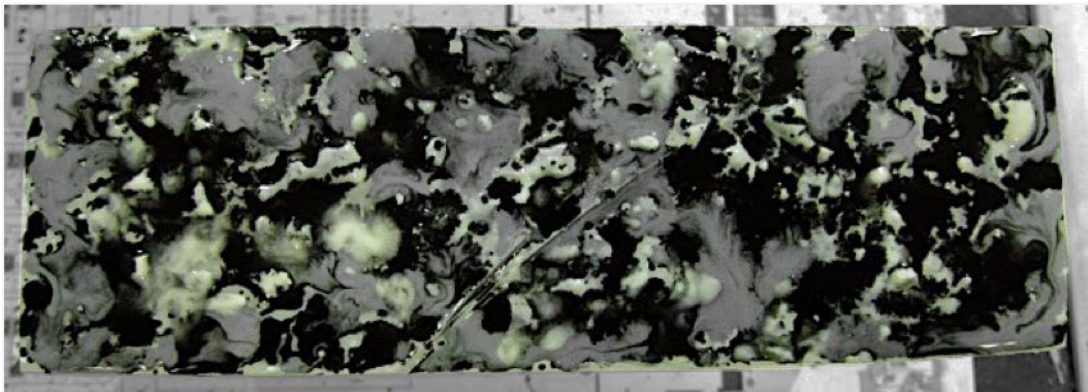

Figure 128 Thin layer (less than 1mm) of opaque black, grey and white Kugler Colours powders, suspended in a rice gluten solution, applied to clear lead crystal slab (top view), ready for reassemblage (with similar slabs) for casting, 2013, 19x8x(variable slab thicknesses)cm. Photo: Sheila Labatt

³⁶¹ Further exploration in crystal, based on the present research, will require identifying crystal glassblowing and kiln casting facilities – usually industrial – which support artists working in glass.

³⁶² When grinding, cutting, grinding or engraving, a steady stream of cool water must flow over the glass so that the friction will not overheat the glass and cause it to break.

dust from contaminating the air.³⁶³ Finally, I reassemble the block [Figure 129] and pour a refractory mould around it, so that it can be re-cast, trapping the colour inside.³⁶⁴

Prior to pouring the new mould, it is critical to completely seal spaces between the slabs, to prevent investment material from flowing into them and becoming trapped inside the piece, ruining it. Two layers of lightweight yet strong clear packaging tape are usually sufficient, particularly if the glass surface is polished because the tape adheres well. Out of an abundance of caution, though, I use up to five layers, each one at a 90-degree angle to the previous one.³⁶⁵ I then seal the entire block with yet another layer of tape. (The tape and rice gluten burn out during firing, leaving no residue, and fumes are negligible.)

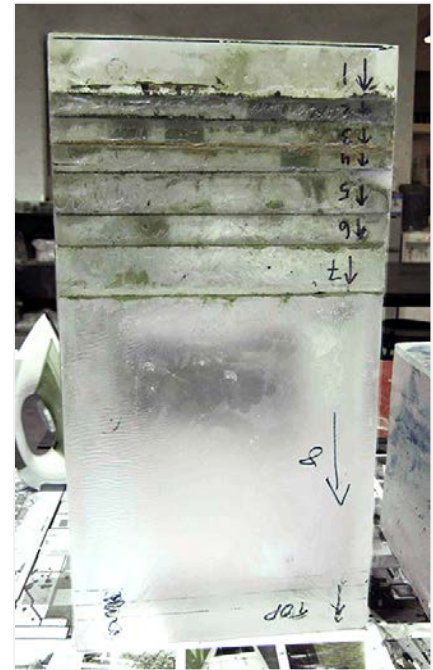

Figure 129 Eight slabs like the one in Figure 128, reassembled with powder inclusions, ready for taping and re-casting. Photo: Sheila Labatt

After the second firing, the clear object will have parallel lines of embedded colour, where the slabs have abutted each other. Nearly imperceptible movement in the colour will have taken place, as can be seen in the top section of Figure 168, below.

b) *Fusing Colour onto Sheet Glass*

Another process, also based on the principle of fusing colour between layers of

³⁶³ I created the works shown in Figure 128 and Figure 129 in lead crystal in the glass studio of Shanghai University, where I keep a supply of the material. I used rice gluten solution as a binder because it was a staple in the Shanghai studio, where it was mostly used for pâte de verre. Diluted PVA glue or acrylic medium can also be used.

³⁶⁴ See Appendix V, Test #17

³⁶⁵ It is useful to use clear tape so that one can see through to the previous layer and find the spots that still need covering.

glass, requires colour – in this case powders, eggshells,³⁶⁶ stringers³⁶⁷ or cane³⁶⁸ – to be fused into sheets of transparent glass [Figure 130], that will later be assembled and re-fired to create a three-dimensional object. In this instance, three-dimensional inclusions, such as stringers, can be used. Once the stringers have fully fused into the sheet glass (at 820°), the element will have become two-dimensional again [Figure 131]³⁶⁹ and can be stacked tightly with other elements prior to casting.³⁷⁰

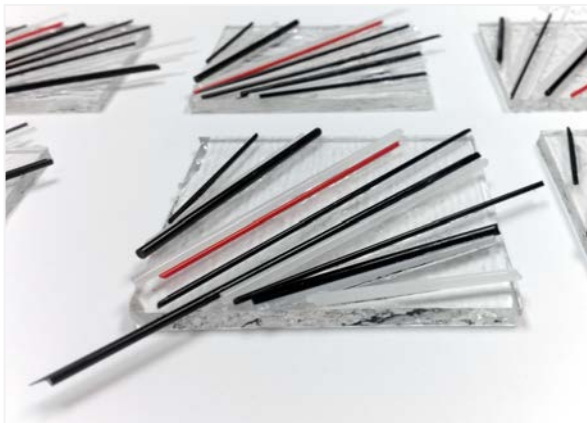

Figure 130 Preparation of elements for fusing, using 60x60x3mm Bullseye sheet glass (Tekta) and 2 and 1mm stringers. Photo: Sheila Labatt



Figure 131 Fused Bullseye element, stringers flush with the glass sheet. Photo: Sheila Labatt

c) *Hot Casting with Colour Inclusions*

Hot casting can also be used to introduce colour into otherwise transparent, molten glass. The technique is useful for embedding thick objects, like cane, which I use to evoke calligraphy.

³⁶⁶ Thinly-blown glass, used broken in this project, and fused to Bullseye elements.

³⁶⁷ Threads of glass. Bullseye stringers of 0.5 to 2mm in diameter were used in this project.

³⁶⁸ A stick of glass made by stretching molten glass

³⁶⁹ See Appendix V, Test #38

³⁷⁰ Stringers and other three-dimensional inclusions cannot be used when trapping colour between slabs, as in technique (i). If 3D objects were placed between the layers, they would create large gaps between the slabs and would prevent them from being reassembled tightly enough. A layer of glass powder, on the other hand, is thin and does not affect reassembly of the slabs.

Rather than beginning with cold, clear glass slabs or sheets, as in the two previous techniques, molten glass is gathered and taken straight from the furnace to a mould.

The mould can be made either of refractory investment material and be located inside a kiln, pre-heated to about 600° to avoid thermal shock [Figure 132], or be fabricated in steel, placed on a marver and pre-heated by several 'throw-away' gathers [Figure 133].

During the process, hot glass is either ladled or dripped from a gather in stages, adding powders or pre-heated cane to the molten glass between gathers.³⁷¹ Each new layer traps the colour inside the glass.



Figure 134 Adding and manipulating cane inclusions with tweezers. Photo: Sheila Labatt

The inclusions

can be placed flat against the molten glass and covered over with a new gather. They can also be quickly manipulated, as they begin to soften on the hot glass, by pushing or dragging them with a long pair of stainless steel tweezers, and then covered with a new gather [Figure 134]. The manipulation itself can add a third dimension to the inclusions but the glass cools down too quickly to allow for extensive or planned manipulation, adding a layer of spontaneity.



Figure 132 Hot casting Glasma glass and flameworked Gaffer cane into refractory mould, inside kiln, pre-heated to 600. Photo: Sheila Labatt

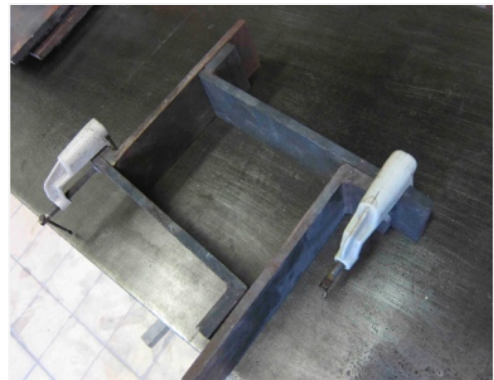

Figure 133 Steel mould on marver, pre-heated by several 'throw-away' gathers, ready to accept molten glass. Photo: Sheila Labatt

³⁷¹ To avoid breakage, I usually heat the cane to 500°, either in a small kiln or on the edge of a refractory mould, before inserting it into hot glass.

I therefore framework cane inclusions prior to inserting them into the hot glass because this provides more time and control in planning the work. In the torch, I can bend the cane exactly as I choose while stretching and compressing the material to give it a variety of line thickness and weight, as would be the case in Grass script. Finally, frameworking allows me to pull the blunt ends of the cane into gradual tapers, which are also an important characteristic of brush and ink linework [Figure 135].



Figure 135 Frameworked inclusions, warming in a kiln, on the top surfaces of moulds, for quick inclusion into hot glass. Photo: Sheila Labatt

Cane must be pre-warmed to about 500°C prior to placing it in the molten glass, lest it crack from thermal shock. I find that the easiest way to accomplish this is by placing frameworked cane, for example, directly on the top surface of the mould, which is also pre-warming in a kiln [Figure 135]. This means that the inclusions are close to their destination, and if one drops, at least it lands inside the mould.

Even after carefully frameworking the inclusions, I often manipulate them with tweezers as well, inside the molten glass, to combine elements of control (frameworking) and chance (quickly worked inclusions). This adds an additional sense of flow to the lines, while maintaining their varied weight and tapered ends, and an element of spontaneity to an otherwise controlled preparation process [Figure 136].³⁷²

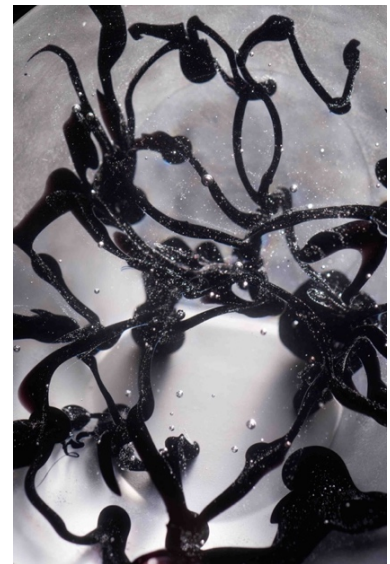

Figure 136 *Grass Script II* (detail), 2015, Sheila Labatt, manipulated, frameworked Gaffer cane inclusions in hot cast Glasma glass, diameter Ø15x15cm. Photo: Sylvain Deleu

³⁷² See Appendix V, Test #107

Finally, eggshell pieces with pre-fused colour [Figure 137] can be manipulated, during hot casting, to yield highly distorted, abstract brush and ink-like painting effects [Figure 138].³⁷³ Because eggshells are so much thinner than cane, they soften on contact with the molten glass and are easier to work than cane inclusions, increasing the sense of immediacy and *spontaneity of action* in the finished piece.



Figure 137 Fused black ceramic enamel powder and acrylic medium painted onto slumped Glastma eggshells (about 1mm thick), in Asian cloud motif, 2012. Photo: Sheila Labatt



Figure 138 Block of hot cast glass (detail), 2012, with distorted eggshell inclusions showing spontaneous, gestural, brush and ink-like marks, 28x12x11cm. Photo: Sheila Labatt

4. Manipulating Inclusions Three-Dimensionally

a) *Introduction*

Once colour has been introduced into the glass, and perhaps slightly manipulated with tweezers, the next stage in my process – to manipulate the colour – requires another casting. In each technique, the goal is to cause the glass to move and the inclusions to transform into three-dimensional marks that *appear* to be spontaneously-executed in brush and ink. Each method comprises a balance of control and chance.

³⁷³ See Appendix V, Test #15

b) *Flow into a Void*

One way of transforming two-dimensional elements into the third dimension is to have them flow inside a mould that is larger and/or of a different shape than the initial components.

Flow is of primary concern in this project, so I conducted a series of small-scale, controlled and replicable tests to examine the behaviour of glass as it flows into a void.

For this, I fused, onto clear Tekta³⁷⁴ sheets of 60x60x6mm:

1. stringers in parallel lines, grids or other geometric patterns [Figure 139]³⁷⁵
2. powders [Figure 140]³⁷⁶
3. eggshells blown in a torch [Figure 141]³⁷⁷
4. dots (made by kiln firing frits, causing them to contract into spheres), in regular and random arrangements [Figure 142]³⁷⁸

I then assembled the square, fused elements in sets of four different configurations, and arranged them in rectangular Ceraboard³⁷⁹ moulds of

³⁷⁴ Bullseye's range of 'Tekta' sheet glass is available in thicknesses of 3, 4 and 6mm. I use 6mm sheets to create these elements because this glass shrinks or stretches to a thickness of 6mm when fired to melting temperature. In this case, the elements retained their thickness and shape, post firing. The elements in Figure 142, for example, shrank because 3mm rather than 6mm Tekta was used. See: Bullseye Glass Co., 'Technotes – Volume and Bubble Control: Understanding Distortion and Trapped Air When Firing Bullseye Glass', nd <https://www.warm-glass.co.uk/images/pdfs/Bullseye%20TechNotes_05.pdf> [accessed 18 July 2017]

³⁷⁵ See Appendix V, Test #49

³⁷⁶ See Appendix V, Test #87

³⁷⁷ See Appendix V, Test #78

³⁷⁸ See Appendix V, Tests #86 and #81

³⁷⁹ A refractory board that, when coated with kiln wash, acts as a support and separator during casting. It can be cut and used flat on the kiln shelf or as a material to create small moulds. For these tests, I assembled cut boards, using ordinary sewing pins to build moulds that were strong enough to support relatively small amounts of molten glass.

9x7x5cm, leaving empty space into which the glass would flow at 820°.

The tests in which I used elements with parallel lines proved the most instructive since they allowed me to see clearly how far and in what direction the lines and grids had flowed and stretched. Four line tests, therefore, are used as examples [Figure 143].³⁸⁰

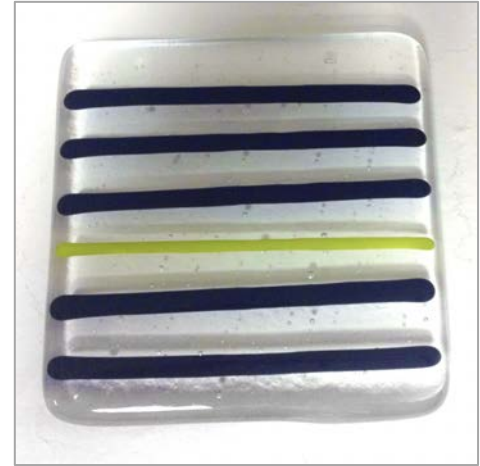

Figure 139 Fused 2mm stringers, 60x60x6mm. Photo: Sheila Labatt

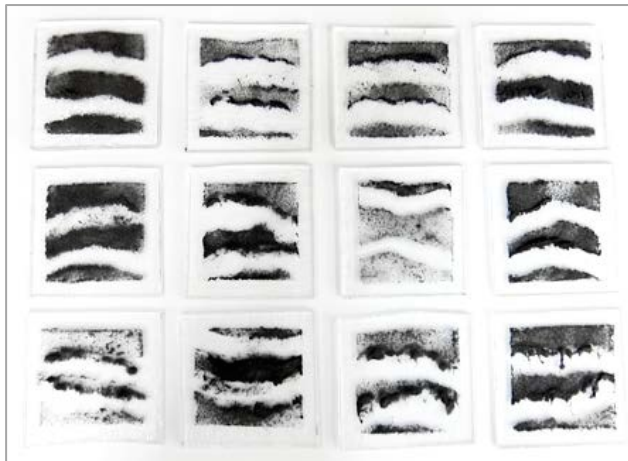

Figure 140 Fused black powder on Tekta, 60x60x6mm each. Photo: Sheila Labatt

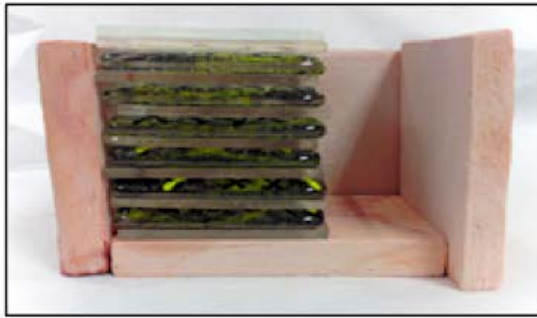

Figure 141 Fused eggshells on Tekta, red circles designate good liquid ink-like effects, 60x60x6mm. Photo: Sheila Labatt

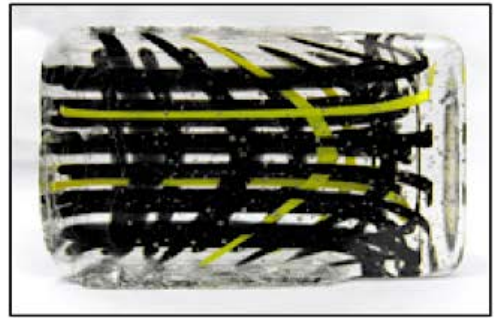

Figure 142 Bullseye dots fused on 3mm Tekta, in regular (left) and random (right) arrangements. 60x60x6mm each. Photo: Sheila Labatt

³⁸⁰ See Appendix V, Tests #50-53. Similar tests, using different line patterns, fused powders, eggshell and dots are recorded in Appendix V.



Side View. Horizontal setup



Top View. Result 90x70x50mm



Top View. Vertical, lengthwise setup



Top View. Result 90x70x50mm

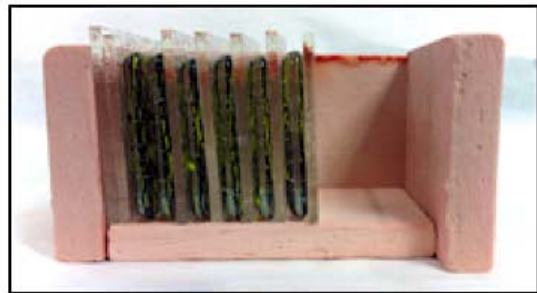

Side View. Vertical, crosswise setup

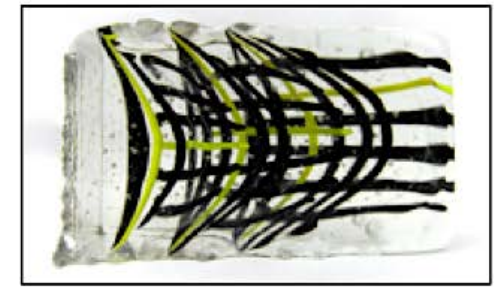

Top View. Result 90x70x50mm



Top View. Vertical, diagonal setup



Top View. Result 90x70x50mm

Figure 143 Four Bullseye flow test set-up configurations, with voids, in fabricated Ceraboard moulds (left column) and results (right column). Photos: Sheila Labatt

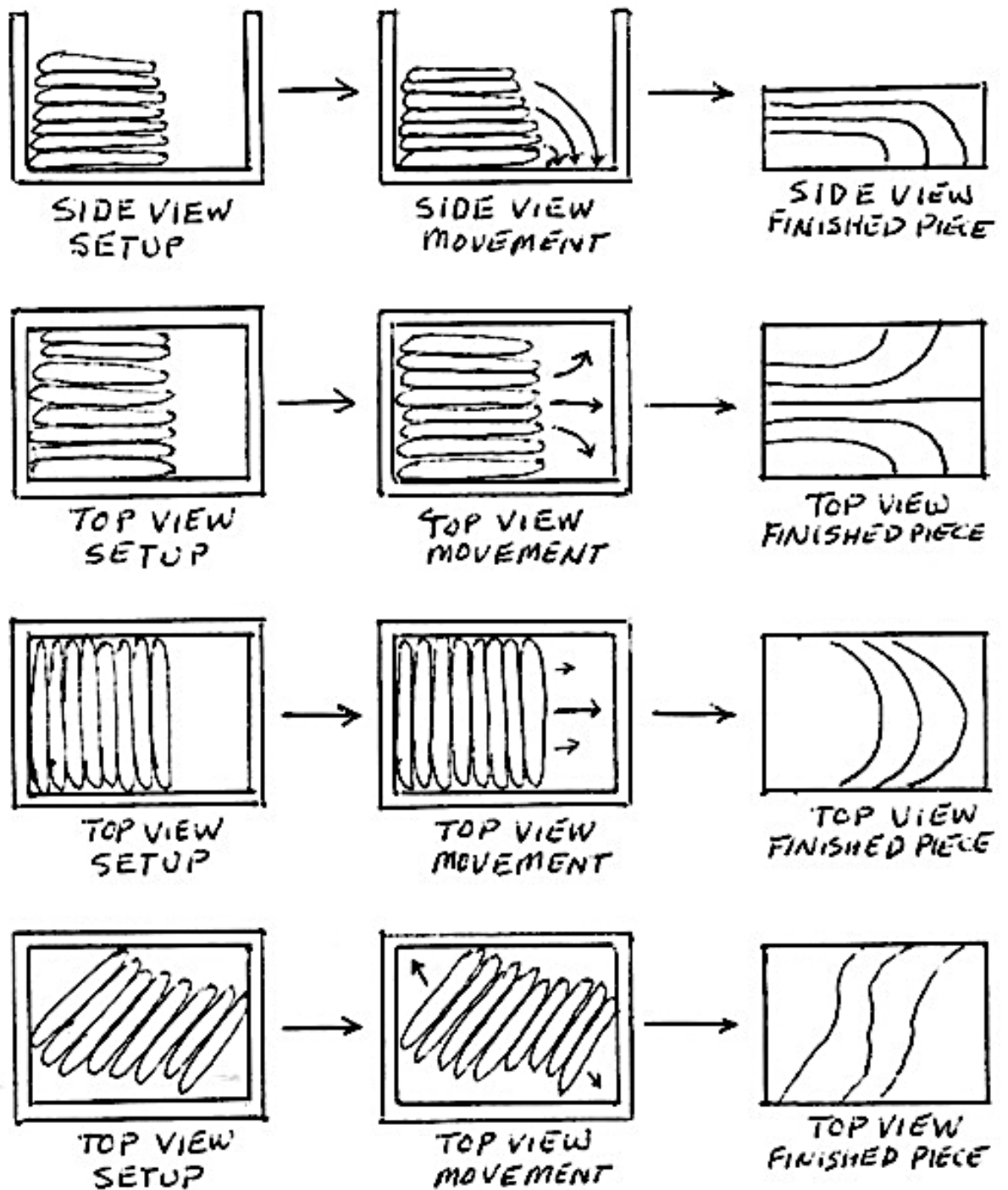

Figure 144 Diagram of glass flow results based on the different set-up configurations shown in Figure 143. Illustrations: Sheila Labatt

The flow trajectory was photographed from above, in all cases, for comparison's sake [Figure 143]. These results allowed me to create a schematic diagram showing glass flow under specific conditions [Figure 144],³⁸¹ from which I extrapolated the findings to help design larger pieces, in different forms, using Glastma furnace glass.

I scaled up the Bullseye elements by using custom, hot-cast Glastma billets in either clear glass or glass with powder inclusions [Figure 124]. I created them by picking up glass powders, prior to casting them in a 60x60x30mm purpose-built, stainless steel mould, pre-warmed and sitting on a marver [Figure 145]. The billets were then fired to 890°, in refractory moulds, as cylinders, hemispheres and truncated cones [Figure 146].

If thinner billets are desired, either clear or with powder inclusions, the hot-cast ones can be fired flat on a kiln shelf, lined with ThinFire paper, to full fusing temperature, allowing cane to melt into the billet.³⁸² The resulting (rounded) square billets [Figure 147]³⁸³ work well for creating pieces similar to those in the Bullseye tests [Figure 143], on a larger scale.

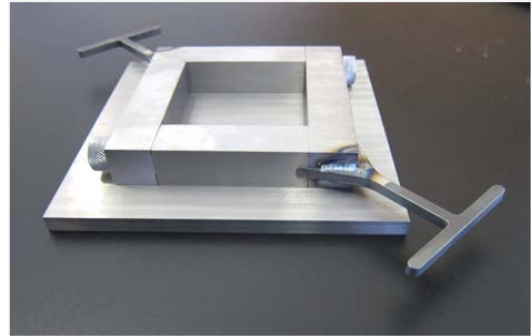

Figure 145 Stainless steel mould for hot casting billets, 6x6x3cm. Photo: Sheila Labatt



Figure 146 Custom clear and 'inky' billets [Figure 124] in conical refractory mould, ready for firing into a void at the bottom of the mould, held open by one horizontal billet. Photo: Sheila Labatt



Figure 147 Clear, slumped Glastma billet with fused cane. Photo: Sheila Labatt

³⁸¹ Square Bullseye sheet glass elements, 60x60x6mm, fired to 820° inside rectangular moulds.

³⁸² Bullseye ThinFire paper is a lightweight, refractory ceramic-impregnated paper used to prevent cast glass from adhering to the kiln shelf.

When large amounts of powder are picked up and hot cast, the colour inside the object is dense. The quality of the 'ink' marks is therefore not immediately visible, and is only revealed when the piece is cut. The imagery inside the block often reads as heavy, ink-like brush strokes, usually associated with contemporary Chinese calligraphy [Figure 148 and Figure 149].³⁸⁴

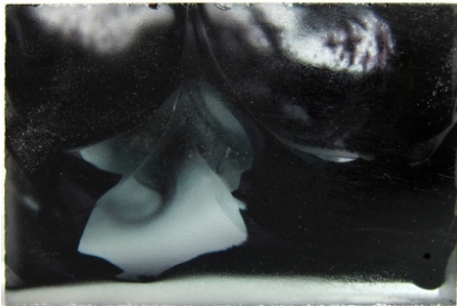

Figure 148 Imagery inside dense, black block is revealed when cut, showing heavy ink-like effects associated with contemporary Chinese calligraphy. 10x8x2cm. Photo: Sheila Labatt



Figure 149 *Kuafu Overtaking the Fleeting Rays of the Sun #20*, 2001, Wang Dongling 王冬龄, ink on paper, heavy application of ink in contemporary Chinese calligraphy, 138x261cm. Source: bonhams.com/auctions/15409/lot/4468/ © Bonhams 2001-2018

The block can also be cut into thinner slices, reassembled and fused into a new object, highlighting the movement of the glass. When the slices are arranged so that the imagery in abutting elements connects, as closely as possible, the result can resemble mountain imagery of traditional Chinese landscapes in high-ratio format scrolls [Figure 150].³⁸⁵



Figure 150 Thin slices from a dense, seemingly 'black' block, appearing blue, assembled and fused to resemble high-ratio format and flowing mountain imagery in traditional Chinese landscape scrolls. 33x10x2cm. Photo: Sylvain Deleu

³⁸³ See Appendix V, Test #110

³⁸⁴ See Appendix V, Test #2

³⁸⁵ See Appendix V, Test #109

c) *Bubbles in Hot Casting*

In hot casting, another way of manipulating colour inside glass is to introduce bubbles into the molten glass, in which cane inclusions, pre-heated to 500°, have been placed, as shown in Figure 134. The bubbles can be created in at least three ways:

First, creating narrow holes in the bottom of a refractory mould [Figure 151] allows air to be trapped when molten glass is introduced. I created holes by affixing wax rods to the top of a plaster form, prior to pouring the mould and used the lost wax process to remove the rods at the bottom of the mould. It is important that the holes be long and narrow, so that the first glass gather is unlikely to fill them while at the same time trapping large volumes of air.



Figure 151 Deep, narrow holes in the bottom of a mould, created using the lost wax process, cause bubbles to rise when air is trapped by molten glass.
Photo: Sheila Labatt



Figure 152 *Out of the Box* (detail), bubbles from bottom of mould, Photo: Sylvain Deleu



Figure 153 *Out of the Box*, 2015, Sheila Labatt, hot cast Glastma furnace glass and frameworked Gaffer cane, holes in bottom of mould created air bubbles, moving cane inclusions to create gestural tapers. Photo: Sylvain Deleu

The kiln is then closed and brought up to full casting temperature of about 890°, causing the trapped air to rise and drag the inclusions upwards, leaving behind tapered, calligraphic lines [Figure 152 and Figure 153].³⁸⁶

³⁸⁶ See Appendix V, Test #61

The second method is to push cold metal tools into each layer of molten glass, temporarily cooling it enough to create divots in the glass.³⁸⁷ For this, I used a chilled, water-laden plunger (9.5x9.5cm head), with seven protruding, unevenly spaced nails [Figure 155 and Figure 156].³⁸⁸



Figure 155 Wooden plunger with chilled nails quickly cools molten glass to create depressions that will become air pockets, then bubbles, when the next layer of molten glass covers them. Photo: Sheila Labatt.

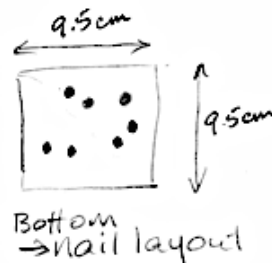

Figure 156 Placement of nails in wooden plunger, diagram from studio notes. Sketch: Sheila Labatt



Figure 154 *Out of the Box III*, 2015, Sheila Labatt, Glastma furnace glass and flameworked Gaffer cane, nail plunger created divots to trap air, creating bubbles to move cane inclusions into gestural tapers. Photo: Ester Segarra

The divots created with the nails hold their shape long enough to trap air when the next layer of hot glass is added. Those air pockets become bubbles and rise as the casting continues, dragging inclusions with them to create long, gestural and apparently spontaneous three-dimensional, ink-like lines [Figure 154].

³⁸⁷ The plunger must be well-soaked in cold water to prevent the wood from burning and to cool the nails, to make them most effective in creating divots. This is similar to the originally Swedish decorative glassblowing 'ariel' technique, in which hot glass is gathered over a void, to trap air, and is then blown. See, for example, Ray Flavell, 'The Development and Application of the Use of Encased Voids Within the Body of Glass Artefacts as a Means of Drawing and Expression' (PhD Thesis, Edinburgh College of Art / Heriot-Watt University School of Design and Applied Arts, 2001)

³⁸⁸ See Appendix V, Test #59

The third technique for creating bubbles in hot casting falls within the realm of chemistry rather than physical manipulation. A pinch of baking soda (sodium bicarbonate) is placed on the bottom of the mould, prior to introducing the molten glass.

As the gathers of molten glass are added, the baking soda releases bubbles of carbon dioxide,³⁸⁹ which, like air, rise and drag the inclusions. In addition to creating bubbles large enough to move the glass, this method also generates miniscule seed bubbles that remained trapped inside the object [Figure 157].³⁹⁰

This technique is equally effective – though more difficult to control – for creating apparently spontaneous, calligraphic movement and, whereas the larger bubbles fired out, these tiny ones help create an atmospheric feel. Care must be taken, though, not to use too much baking soda or the piece will fill with seed bubbles, obscuring the graphic, ink-like imagery.



Figure 157 *Out of the Box II*, 2015, Sheila Labatt, sodium bicarbonate creates carbon dioxide bubbles that run through cane inclusions during hot casting, creating 'seed' bubbles (upper third) that remained trapped inside the piece. Photo: Ester Segarra

d) *Bubbles in Kiln Casting*

'Bubble running' is not an exact science. The firing schedule for each piece constitutes an educated guess based on the relative success of previous work. The schedules differ slightly for each piece and depend on the volume of the bubbles, the larger of which will travel further inside molten glass. The schedule is also designed according to the distance I wish the bubbles to travel, given the

³⁸⁹ Under the influence of heat, sodium bicarbonate (NaHCO_3) decomposes into sodium carbonate (Na_2CO_3), carbon dioxide (CO_2) and water vapour (H_2O).

³⁹⁰ See Appendix V, Test #60

dimensions of the piece, and the placement I hope to achieve for those bubbles – for instance, integrated within the colour or in the middle of a negative space.³⁹¹

Manipulating inclusions in kiln casting works in a similar way to hot casting in that bubbles can drag colour (and veiling, in the case of kiln casting) to produce gestural, ink-like results. The set-up is controlled both physically and in terms of firing schedules. During firing, though, the bubbles take over to create an element of chance and the spontaneity that is central to this research.

In the following casting methods, bubbles flowing through the molten glass mean that the glass is simultaneously flowing *into* the voids left behind by the bubbles, as they rise within the piece.

In hot casting, bubble running is best suited to manipulating cane (to evoke calligraphy) and other thick inclusions, which can be manipulated as the casting progresses. Kiln casting works better with powder inclusions (to evoke ink wash). Figure 128 and Figure 129 show how powders can be applied on slabs of glass. When the slabs are assembled, taped and fired, the colour becomes trapped inside the resulting block of glass. Since the slabs need to fit together tightly, three-dimensional cane and stringers are not suitable as inclusions using this technique for kiln casting.

One method of bubble running involves the same powder technique and begins with a hot or kiln cast clear block, cut into slabs. Holes are then drilled through each slab, prior to laying down glass powder that will become trapped inside the piece [Figure 158].

³⁹¹ It took me several years of trial and error, prior to this research, while I was working in Shanghai, to develop firing schedules in which a high enough temperature is reached, to allow the glass and bubbles to flow freely. On most occasions, cooling needs to occur at the ideal time, for bubbles to remain trapped and form an integral element in the work. On others, though, it is desirable for the bubbles to ‘fire out’ and leave behind only the traces of movement in the inclusions.

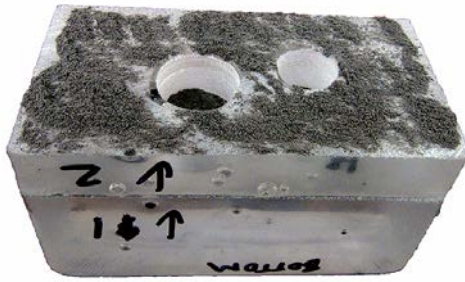

Figure 158 Sliced and drilled lead crystal slabs, with powder, ready to accept next slabs, to rebuild the block. Photo: Sheila Labatt

The block is then reassembled, taped and re-cast, as described above. The holes become bubbles in the molten glass and rise through the block, dragging the colour with them, to resemble a mountain in a Chinese landscape [Figure 159].

Tom Patti used standard thicknesses of mirror-like, industrial sheet glass and one perfectly centred bubble to create his geometric *Asahi Lumina with Bronze and Mirrorized Disk* [Figure 90]. My work, though, relies on planning bubble size and trajectory that are deliberately dissimilar. Initially, I cut the slabs into unequal thicknesses. I then drill holes of different diameters in varying patterns on each layer, to allow a bubble from one slab to affect those above it, as it travels towards the surface, when molten.

A single bubble rises in a straight, vertical line. Multiple, offset holes, on the other hand, create a 'butterfly effect' in that a bubble, when acted upon by another, can travel unpredictably and organically, catching still others on its way. Uneven, spontaneous shapes and negative spaces are therefore created. The difficulty is in predicting how each bubble will affect the other to produce well-balanced imagery, such as that seen in Chinese landscapes.

Tom Patti used standard thicknesses of mirror-like, industrial sheet glass and one

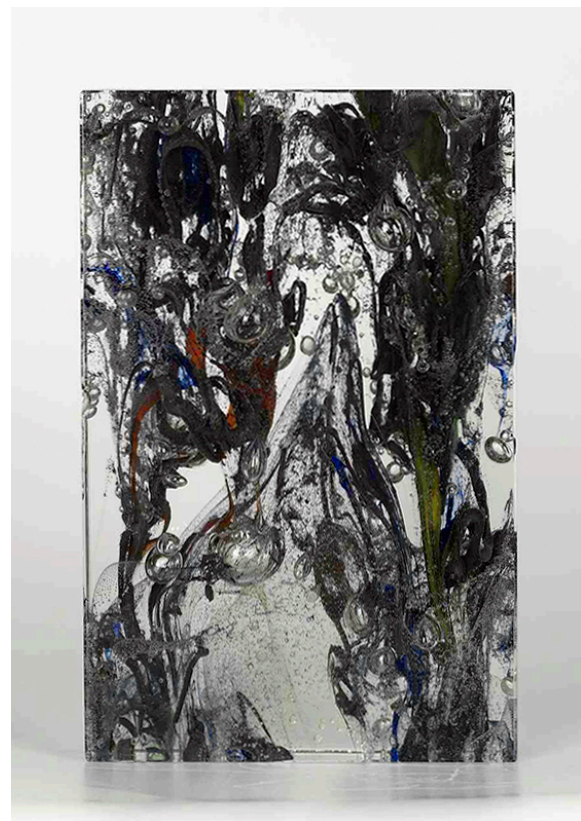

Figure 159 *Shan Shui 山水 #5*, 2008, Sheila Labatt, fired crystal and Kugler Colours powders, demonstrating bubble travel dragging colour asymmetrically, due to varying slab depths and hole diameters and placement. 24x15x5cm. Photo: Xiao Jin

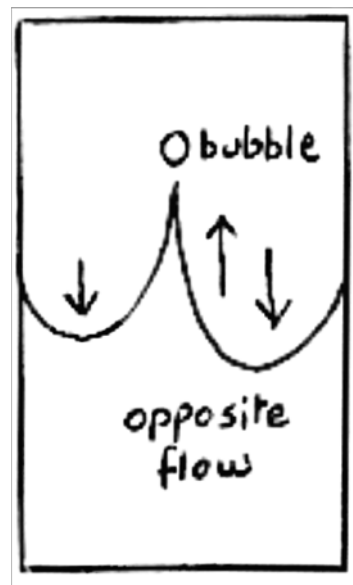

Figure 160 Equal and opposite flow. Sketch: Sheila Labatt



Figure 161 *Ink Pot*, 2010, Sheila Labatt, cast crystal and Kugler Colours powders, rising bubbles push colour inclusions down, demonstrating equal and opposite reactions. 21x6x5cm. Photo: Sheila Labatt

A final consideration, when designing a piece, is that a bubble will drag colour upwards and simultaneously force the surrounding glass and inclusions downwards [Figure 160 and Figure 161].³⁹² This

is can be seen in the veiling of Willi

Pistor's untitled piece [Figure 94] and is in keeping with Newton's third law of motion, in which every action or force has an equal and opposite reaction.

The ability to trap bubbles inside the casting depends on many factors, some of which can be difficult to gauge: the ramp-up speed, maximum top temperature and soak time, bubble size, the height of the piece, the particular kiln in use and even elevation from sea level all need to be taken into consideration.

Although my primary purpose in using bubbles is to drag inclusions to create organic, brush and ink-like imagery, I also plan for trapped bubbles when I am designing my pieces. Not only do they add visual interest, they also evoke

³⁹² These actions also affect any veiling left behind by the original cuts in the block, providing a milky counterpoint to the 'ink'.

water, which is an important concept in Chinese landscape painting; water is half of the word for landscape painting – shānshuǐ (山水) or mountain/water.

Another method of kiln casting with bubbles and colour also begins with a clear block cut into slabs. The colour is added between the layers, though, by subtracting glass from their surface and filling the cavity with glass powder or ceramic enamel prior to reassembly [Figure 162 and Figure 163].

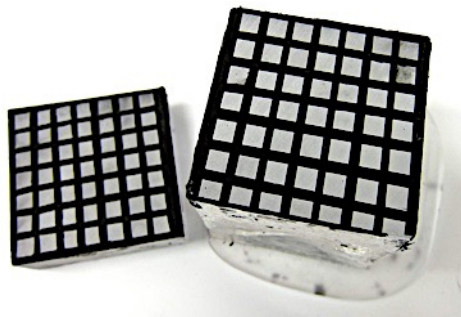

Figure 162 Shallow, sandblasted grids, filled with black ceramic enamel powder. Photo: Sheila Labatt

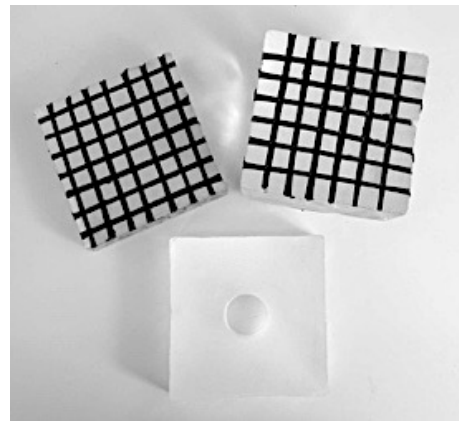

Figure 163 Grid cut on the lathe to a depth of 1.5mm and filled with black glass powder. Photo: Sheila Labatt



Figure 164 Untitled, 2013, Sheila Labatt, Glasma furnace glass and ceramic enamel, shallow sandblasted grid caused black powder to turn blue due to light application of colour. 10x6x6cm. Photo: Sylvain Deleu

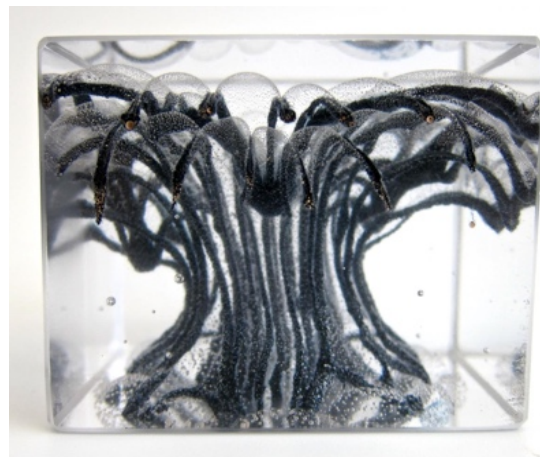

Figure 165 Untitled, 2013, Sheila Labatt, Glasma glass and ceramic enamel, deeper lathe-cut grid with heavier application of colour gives blacker, dramatically different result. 5x7x7cm. Photo: Sheila Labatt

Lines can be sandblasted out, using electrical tape as a resist [Figure 162], or carved more deeply on the diamond lathe [Figure 163].³⁹³ Sandblasting generally leaves a shallower void than carving and therefore takes less powder to fill, leading to dramatically different results [Figure 164³⁹⁴ and Figure 165,³⁹⁵ respectively].

Flameworking allows control in the manipulation of cane to create tapered ends, prior to hot casting it as an inclusion [Figure 135]. A more organic way of causing the ends of the cane to taper, though, is to first hot cast a block using regular cane with abrupt or sharp, broken ends as inclusions and to then cut, drill and re-fire it. If some of the holes are drilled through the irregular ends of the cane [Figure 166], the bubbles resulting from those holes drag the broken tips, rendering delicate, gestural tapers that resemble the ends of brush strokes [Figure 167].³⁹⁶

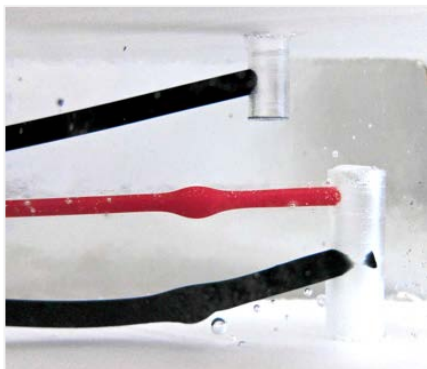

Figure 166 Holes drilled through blunt, sharp and irregular ends of Bullseye stringer inclusions.
Photo: Sheila Labatt



Figure 167 Untitled, 2013, Sheila Labatt, cast Bullseye Tekta and stringers, gestural, even tapers caused by bubbles dragging broken stringer tips, 6x6x6cm. Photo: Sylvain Deleu

³⁹³ As with the Bullseye tests [Figure 143], I used straight lines here because this is the best way to observe the inclusions' movement. Curved lines can also be carved, using the edge of a drill bit or an engraving device.

³⁹⁴ See Appendix V, Test #10

³⁹⁵ See Appendix V, Test #14

³⁹⁶ See Appendix V, Test #101

A final way of using the casting process to create spontaneous-looking imagery utilises the recycling properties of glass. To create the work shown in Figure 168, I ran bubbles through powder inclusions in a lead crystal piece. In this case, the powder was suspended in oil rather than rice gluten solution or diluted PVA glue, giving the 'mountain' element along the bottom, a smooth, slick appearance. Unfortunately, the piece cracked in several places during coldworking, either because of the oil inside the glass or, more likely, because of insufficient annealing.³⁹⁷

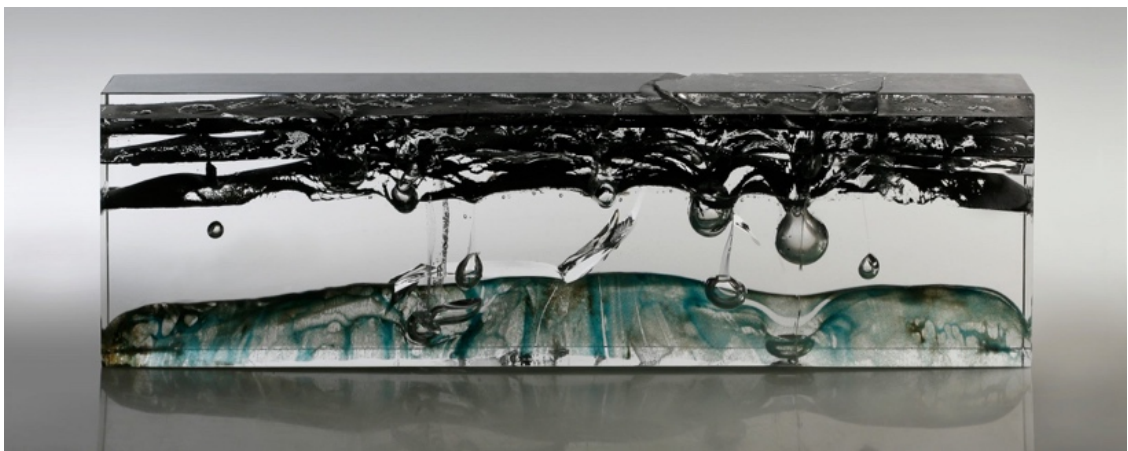

Figure 168 *Da Shan Shui* 大山水, 2009, Sheila Labatt, cracked 'bubble' piece, with brush and ink-like 'grue' inclusions, 26x64x8 cm. Photo: Xiao Jin

Ordinarily, cracked cast glass can be repaired by taping the crack, pouring investment around the object to create a new mould and re-firing it. This process causes the glass to fuse back together and the piece to retain its original form. Here, I wanted to retain the location of the bubbles, so this process was not an option: the bubbles would have either migrated to a new location or fired out of the piece. I therefore decided to create a completely different piece and returned to the idea that is illustrated by the Bullseye tests in Figure 143 and Figure 144: glass flowing into a void created by an oversized mould.

I re-cast the piece in Figure 168 into a differently shaped mould in which the

³⁹⁷ It is unlikely to be a result of colour incompatibility because I have used the same crystal and Kugler Colours powders in many pieces – and in greater concentrations – without any trouble.

original work could sit, surrounded by voids on all sides. Naturally, the bubbles fired out and an entirely new piece was created [Figure 169]. The inclusions had flowed in all directions during firing, and retained an ink-like effect, in black and grue, which I find far more engaging than the original, cracked piece. This result reinforces the importance of a *controlled* set up to then allow time, gravity and *chance* to take over and create apparent spontaneity in casting.



Figure 169 *Tsunami*, 2010, Sheila Labatt, crystal and Kugler Colours powders, re-fired object into an oversized mould with a completely different form, creating a new ink-like effect. 14x71x11 cm. Photo: Xiao Jin

5. Summary

The aim of this research is to manipulate colour inside cast glass. It seeks to emulate brush and ink Grass script calligraphy and black or muted colours of glass powder to emulate ink washes (the Five Colours of Black), found in traditional Chinese landscape paintings.

In this chapter, I begin by explaining my reasons for choosing certain types and brands of the glass I have used in this project, because each one affects the techniques I describe.

To manipulate colour inside the glass, one must first introduce inclusions with which to work. The chapter describes several ways that I have used for doing so: trapping colour between glass slabs, fusing colour onto glass sheets and hot casting with colour inclusions. I then describe methods for manipulating the colour: casting into voids and using bubbles in both hot and kiln casting.

The techniques described in this chapter were used in the finished work, described in Chapter VI. For each piece, two or more of these processes were combined to achieve spontaneous, three-dimensional brush and ink-like inclusions.

VI RESULTS

1. Introduction

In this section, I discuss finished work as examples of the techniques that I described in Chapter IV. For each piece, I also examine its aesthetic qualities and ability to recreate characteristics of calligraphy and traditional landscape painting, *shān shuǐ* – mountain/water. I also detail the materials and techniques used for each piece, the hybridity of which form the basis of my contribution to knowledge.

Each of these pieces is unique and cannot be replicated, though the techniques themselves are duplicable, based on the information I have provided here and in Appendix V – Tests and Results. The colours of glass I have used are all transparent but appear opaque when used in relatively dense cane. In thin applications of powder, used to create ‘ink washes’, black appears blue.³⁹⁸

Finally, each of these pieces was ground and polished. Coldworking techniques used to finish the pieces are not described here, since the focus of the project is on casting, as I have defined it.³⁹⁹

³⁹⁸ See Chapter V – Techniques Explored in this Project > Choice of Glass

³⁹⁹ See Chapter II – Casting, Spontaneity and Flow > Casting Definition and Context > Temporal Placement of Casting

2. Evaluation

a) *Grass Script II*



Figure 170 *Grass Script II*, 2015, Sheila Labatt, cast glass and flameworked inclusions, Ø15x15cm, $\frac{3}{4}$ front view. Photo: Sylvain Deleu

This truncated cone [Figure 170] exhibits lyrical, three-dimensional Grass script-like line inclusions that seem to float, as does Tani's three-dimensional *Ghost* [Figure 116]. The fluidity of the lines also evokes the immediacy of painting (spontaneity of action) by an artist in a state of wúwéi.⁴⁰⁰

As in Grass script calligraphy [Figure 171], the dense black lines are graphic, gestural, meandering and loose yet assured. These dynamic lines also vary in length and weight and are fluid, rhythmic and expressionistic.

The lines appear unpredictable, having been executed in a single, continuous movement of the brush. They seem to have been painted with ease and dynamism, resulting in an overall flowing and cursive immediacy of expression. In addition, they draw the viewer into the piece, as large-scale, sublime works of calligraphy do.

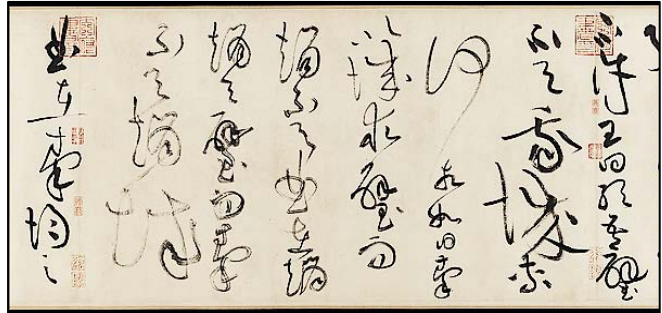

Figure 171 *Biographies of Lian Po and Lin Xiangru* (detail), c.1095, Huang Tingjian, ink on paper, Grass script calligraphy, showing fluid, gestural and spontaneous strokes with a good balance of ink and 'blank' space, 34x1,840cm handscroll. Collection: The Metropolitan Museum of Art, New York (1989.363.4)

Although dry brush techniques sometimes appear in brush and ink Grass script, no such 'strokes' are found inside this piece. Instead, the lines are densely saturated, asymmetrically rounded and soft – neither straight nor sharp – and they flow into and away from one another organically. Just as composition, including the ratio of line to blank space, is essential in Chinese painting. The balance in this piece is appropriate for the size and form of the object.

Whereas the vertical lines of Grass script calligraphy, read right to left, would usually be applied to a two-dimensional writing surface – paper or silk – the calligraphic lines in *Grass Script II* are framed and distributed within and around

⁴⁰⁰ See Chapter II – Casting, Spontaneity and Flow > Spontaneity and Flow: Elusive Immediacy in Cast Glass > Spontaneity of Effect, shibusu (渋さ) and wúwéi (无为)

the object to create three-dimensionality, as I have defined it.⁴⁰¹ The viewer is invited to look *into*, rather than at, the piece in order to discover the line qualities and their composition.

When viewed through the unpolished, translucent exterior of the piece [Figure 172] the lines appear fainter and slightly blurry like brush strokes that are allowed to seep through xuān paper to create a second, less saturated or crisp painting on an underlying supporting page.⁴⁰²



Figure 172 *Grass Script II*, 3/4 view, translucent exterior softens the inclusions, facets cut to 90° for balanced profile, Photo: Sheila Labatt

Finally, the bottom (narrower end) of the cone was cut into two facets, coming together at 90° [Figure 172], giving the overall form of the piece a balanced profile.

Purpose and Process:

My purpose was to create Grass script-like inclusions, using hot casting and flameworking techniques.

I gathered clear, Glastma furnace glass, introduced directly from the furnace into a conical plaster/silica mould, reinforced with shredded fibreglass, which had been preheated to 600° and was sitting inside a nearby top loading kiln.

⁴⁰¹ See Chapter III – Ink > Ink and the Third Dimension > The Third Dimension Problem in Art

⁴⁰² See Chapter III – Ink > Colour and Chops

Preheating the mould is crucial so that it does not suffer thermal shock and break when the hot glass is introduced.

I flameworked and manipulated cane pulled from Gaffer Black 050 (96 COE) to create the elements (inclusions) that were to be used in the piece. After each 'gather and pour' into the mould, I quickly and carefully placed the black flameworked cane elements into the hot glass and manipulated them using long tweezers. A convenient place to preheat the flameworked elements is on the rim of the mould, as the mould itself is being warmed in the kiln, so that they do not have to travel far to be placed into the mould between gathers [Figure 173].



Figure 173 Flameworked Gaffer cane inclusions. Photo: Sheila Labatt

As with preheating the mould itself, preheating the elements helps them avoid thermal shock when introduced into the hot furnace glass. Cracking or breaking due to thermal shock would result in sharp tips and broken lines and would, therefore, no longer evoke Grass script.

Once I had filled the mould, the kiln door was closed and the temperature was taken up to 890°,⁴⁰³ to allow the inclusions to move spontaneously, and *of their own accord*.⁴⁰⁴

The firing cycle included a soak at top temperature⁴⁰⁵ that allowed any bubbles trapped inside the casting to flow up and either fire out of the piece or remain on

⁴⁰³ Glass was introduced into the mould at 600° and was then fired according to the schedule detailed in Appendix V, Test #107

⁴⁰⁴ See Chapter II – Casting, Spontaneity and Flow > Spontaneity and Flow: Elusive Immediacy in Cast Glass > Spontaneity and Flow: A Working Definition

⁴⁰⁵ Soaking is a process in which the kiln is held at a given temperature to allow the entire volume of glass time to arrive at the same temperature.

its top surface, prior to annealing and cooling to room temperature [Figure 174].
I later ground off the surface bubbles.



Figure 174 Surface bubbles to be ground out during coldworking.
Photo: Sheila Labatt

The result shows strong, saturated ink-like marks evoking well-balanced Grass script calligraphy [Figure 136 and Figure 170].

b) *Ink Pot II*



Figure 175 *Ink Pot II*, 2015, Sheila Labatt, cast glass, Ø15x15cm. ¾ view.
Photo: Sylvain Deleu

Unlike *Grass Script II*, with its lower line to negative space ratio, *Ink Pot* [Figure 175] reads as a black hole or vortex into which light can penetrate but not escape.

It evokes the contemporary calligraphy of Wang Dongling 王冬龄, widely regarded as the best living contemporary calligrapher in China [Figure 176]. He uses large brushes, heavily laden with ink, and often paints on the floor using whole body movement to create large, dramatic works.



Figure 176 *Untitled (detail)*, 2006, Wang Dongling, ink on paper, heavy application of ink, in broad, dynamic, slashing strokes, covering most of the page, 125x210cm.
Credit: Michael Goedhuis Gallery

Wang's works are laden with heavily applied and saturated ink, which covers more of the page than does traditional calligraphy [Figure 171]. Although contemporary calligraphy does not seek to reproduce legible characters, it nevertheless evokes traditional calligraphy in the materials used – the Four Treasures of the Study – and the relaxed, meditative state and dynamic body language of the painter.

Ink Pot II renders that same bold, balanced, energetic and unconstrained aesthetic, in the third dimension. The 'ink' imagery evokes the work of a confident, dynamic brush and ink painter, whose mastery of materials and state of wúwéi are evident in the robust simplicity and vitality of their work.

Purpose and Process:

My purpose was to create a hot cast piece, evocative of contemporary brush and ink calligraphy.

I used Glasma furnace glass to hot cast *Ink Pot II* into a conical Crystalcast⁴⁰⁶ mould, which had been pre-heated to 600° and was sitting on the floor of a kiln in the hot shop. I left the bottom three gathers clear and the upper ones rolled in dense Gaffer Black (G050) powder prior to casting. The kiln temperature was then brought up to 890° to allow any bubbles to escape and the glass to flow freely.⁴⁰⁷

The result evokes a loose, heavily saturated application of ink, reminiscent of contemporary brush and ink calligraphy.

⁴⁰⁶ Crystalcast is a commercially available, pre-mixed refractory investment powder that, when mixed with water, produces particularly strong moulds. It can also be used as an additive to strengthen plaster/silica moulds.

⁴⁰⁷ Please see full firing schedule in Appendix V, Test #117.

c) *Wash IV*



Figure 177 *Wash IV*, 2016, Sheila Labatt, cast glass, Ø15x20cm. Photo: Tania Dolvers

Like *Ink Pot II*, I created *Wash IV* [Figure 177] using black glass powder but this piece represents a more traditional ink wash aesthetic. However, it evokes a darker, more mystical rendering of clouds, mountains and water than in traditional Chinese landscape painting.

The saturation and variation in colour of the inclusions give a dramatic turbulence to the piece, which can also be read as ether or dark matter, evoking the infinite ‘mystery and terror’ of the universe that is also seen in Chinese landscapes that juxtapose villages and people with vast mountainscapes.⁴⁰⁸

⁴⁰⁸ Nicolson, p. 323

The sense of moody turbulence in the piece is more often seen in contemporary Chinese landscapes [Figure 178].

The black powder 'ink wash' turned blue during firing, due to the oxides used to create 'black' glass and to its light application.⁴⁰⁹ Like ink of any colour, though, it is able to render the full range of seemingly opaque through to transparent washes, described as the Five Colours of Black.⁴¹⁰ The piece, therefore, sits in sharp contrast to *Ink Pot II*, where the light does not penetrate the dense colour.



Figure 178 *Mountains Hidden in Clouds and Mist*, 2008, Li Huayi, ink and colour on paper, this contemporary Chinese landscape is moodier than traditional Chinese landscape painting, evokes the sublime and maintains a good balance of traditional blank and painted space, 120x240cm. Source: Beijing Centre for the Arts

Like ink wash, glass powder effectively communicates a sense of flow, gesture and rhythm in a dynamic, expressionistic – even sublime – aesthetic. The apparently spontaneous ease of ink application seen in *Wash IV* reflects the soft yet defined nuances seen in traditional ink washes and echoes the depth of tone and harmonious atmosphere of traditional shān shuǐ paintings, in which mountains vibrate with qì.⁴¹¹

Purpose and Process:

My purpose was to create an ink wash effect in a kiln cast piece.

Unlike the cone-shaped pieces described above, which were all hot cast, I kiln cast this one using bespoke hot cast billets.

⁴⁰⁹ See Chapter V – Techniques Explored in this Project > Choice of Glass

⁴¹⁰ See Chapter III – Ink > Wash > Wash Qualities

⁴¹¹ See Chapter III – Ink > Wash > Landscape

I cast each 6x6x2cm billet into a steel mould in the hot shop, using one gather each of clear Glasma furnace glass, which had first been rolled in opaque, Gaffer Black (G050) glass powder. The result is that each billet had unique 'ink wash' markings, in differing intensities of colour.



Figure 179 Mostly vertical billet placement, inside mould, leaving a large void at the bottom into which the glass flowed. Studio sketch

I stacked the billets vertically, leaving a void (held open by one lateral billet) in the bottom of a conical, Crystalcast mould, into which the glass would flow [Figure 179]. I then fired the mould and billets to a top casting temperature of 890°. ⁴¹²

The result shows a flowing, cloud-like, compositionally-balanced, 'ink wash' throughout the piece.

⁴¹² Please see full schedule in Appendix V, Test #116.

d) *Fan*

Fans are not only a symbol of Chinese culture, they are also a surface onto which traditional brush and ink calligraphy [Figure 180] and landscapes are painted.⁴¹³ *Fan*

[Figure 181] resembles calligraphy on Chinese fans both in its form and its embedded line imagery.



Figure 180 Untitled, Ming Dynasty (1368 to 1644), Mo Shilong, brush and ink calligraphy on gold paper, fan shape. Collection: Honolulu Museum of Art (4019.1)



Figure 181 *Fan*, 2014, Sheila Labatt, cast glass, 30x19x5cm. Photo: Sylvain Deleu

Although most Westerners recognise the form as that of a fan, as I had intended, one Chinese scholar interprets the form as a *huáng* (璜), an ancient,

⁴¹³ Flat, oval fans are more traditional and have also been painted since at least the Tang Dynasty (618–907). See: University of Washington, 'Technical Aspects of Painting', *A Visual Sourcebook for Chinese Civilisation*, nd <<https://depts.washington.edu/chinaciv/painting/4ptgtech.htm>> [accessed 20 July 2017]

semi-circular jade ornament [Figure 182].⁴¹⁴ He also views it as half an ancient jade bi 璧 [Figure 73] which can be seen when *Fan* is photographed on a reflective surface [Figure 183].⁴¹⁵

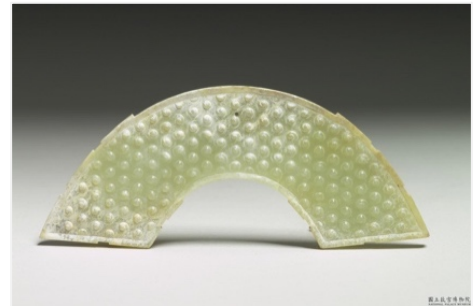

Figure 182 Huáng 璜, Warring States period (500–201 BC), carved jade, 12.2cm (length). Collection: National Palace Museum, Taipei (購玉 000536N000000000)

As in Grass script calligraphy, the lines on *Fan* demonstrate vigorous, rhythmic, fluid and asymmetrical abstraction in varying degrees of line weight, length, tone and strength. Some of the marks also



Figure 183 With its reflection, *Fan* resembles a bi Photo: Sylvain Deleu

evoke ink blots, as in Wang Dongling's contemporary calligraphy [Figure 176], and some are tapered lines, as in traditional Grass script calligraphy [Figure 171]. The lines are also highly gestural and expressionistic and suggest a

⁴¹⁴ Yu Ming Gao 虞鸣皋 interview with Sheila Labatt re: bì 璧 and huáng 璜, Shanghai, 13 June, 2017

⁴¹⁵ See Chapter IV – Glass > Ancient Chinese Glass: Materiality and Appreciation

master calligrapher's heart/mind (心 xīn), energy (气 qì), unconstrained hand and meditative state, which are so important in Grass script.

The vermilion lines are intended to evoke the ubiquitous chop used in Chinese painting.

Purpose and Process:

I first hot cast the piece, as in *Grass Script II* [Figure 172], using pre-warmed, Gaffer Black (G050) and Vermillion (G176) flameworked cane inclusions. I placed these inclusions between gathers of Glastma furnace glass, into a pre-warmed plaster/silica/fibreglass, conical mould, manipulating them with long tweezers, as they softened upon contact with the molten glass. The kiln was then closed and brought up to a top temperature of 900° to provide for maximum movement of the inclusions and to allow any bubbles to fire out.⁴¹⁶



Figure 184 Truncated triangular cross section of fired cone. Photo: Sheila Labatt

Once the cone, Ø15x20cm, had annealed and been un-moulded, I cut it lengthwise into four truncated triangular cross sections [Figure 184] using a diamond saw and cold water.⁴¹⁷ I then assembled the triangles, which revealed strong, calligraphic ink-like lines, flat in



Figure 185 Arrangement of triangular segments in fan-shaped mould. Photo: Sheila Labatt

a new, fan-shaped plaster/silica/fibreglass mould, ensuring that the ends of the inclusions would line up and abut one another as well as possible [Figure 185], to create long, flowing lines that are the hallmark of Grass script calligraphy.

⁴¹⁶ The full schedule is detailed in Appendix V, Test #28

⁴¹⁷ See Chapter V – Techniques Explored in this Project > Introducing Colour into the Glass > Trapping Colour between Glass Slabs

The piece was then re-fired, with the result displaying continuous, fluid and rhythmic lines across the width of the piece.⁴¹⁸ The finished piece also displays dynamic, gestural brush and ink-like lines and dots, with a noticeable patch of milky veiling in the upper right, where the edges of two of the rough, unpolished triangular elements had fused – an unfortunate consequence of using blowing glass for casting [Figure 181]. The veiling in the upper left, on the other hand, is partially obscured by the densely coloured inclusions. Had the triangular sections been polished, prior to re-casting, the veiling would have been reduced, but probably not eliminated.

⁴¹⁸ See Appendix V, Test #35

e) *Fan II*



Figure 186 *Fan II*, 2014, Sheila Labatt, cast glass, 30x19x5cm. Photo: Ester Segarra

Fan II [Figure 186] is another hot and kiln cast fan (or huáng or bì) shape, designed this time to evoke contemporary Chinese landscape painting on fans [Figure 187] rather than calligraphy.

The piece communicates a sense of the sublime in turbulent, tempestuous and dramatic imagery. As is the case with masterful landscapes that demonstrate the Five Colours of Black, the inclusions cover the spectrum from very dark to very light 'wash'. Lines can also be seen, as a counterpoint, both around the edges of the wash fields and in places where those fields overlap, a phenomenon that is also found in ink wash painting and Frankenthaler's colour field paintings [Figure 36].

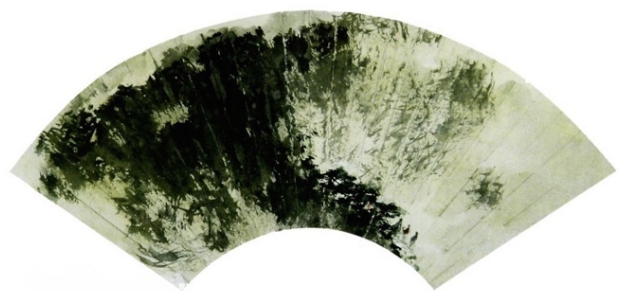

Figure 187 *Shanshui*, c1960s, Fu Baoshi, ink and colour on paper, contemporary, menacing landscape on fan, 14x43cm. Source: nopic.com/show/2/27/2189dee9638000d6

In *Fan II*, the sense of movement, arising from apparently vigorous, expressionistic brushstrokes, helps to convey a feeling of the sublime. Although its scale is small, the piece nevertheless evokes a sense of awe, as do many relatively small shān shuǐ paintings and can also be seen in Wang Qin's *Zen Mountain IV* [Figure 105] that evokes miniature karst mountains set among vast plains.

Finally, in addition to black glass powder, I used light tobacco-coloured powder inclusions not only to provide visual interest but to echo the muted colours used in many traditional Chinese landscape paintings.⁴¹⁹ The colour also evokes yellowed silk backgrounds of antique Chinese landscapes.

Purpose and Process:

My purpose was to create a fan-shaped piece with 'ink wash' inclusions, using Gaffer Black (G050) and Ivory (G102) frameworked cane inclusions and Gaffer Black (G050) and Light Tobacco (G104) glass powders.

I rolled each gather from the furnace in one of the two powders prior to hot casting them into a conical, plaster/silica/Crystalcast, pre-heated mould. I added the frameworked inclusions between gathers, manipulating both the powder and solid inclusions with long tweezers. The kiln was then brought up to a top temperature of 890° to create maximum movement and to allow any bubbles to escape.⁴²⁰

The result showed a nearly opaque cone (Ø15x20cm) [Figure 188] and the internal imagery could not be evaluated until it had been cut. Therefore, I sliced the block lengthwise into four triangular cross sections, revealing strong, internal wash and line characteristics [Figure 189]. As in *Wash IV* [Figure 177], I created this piece using a thin application of black powder, so the inclusions fired to resemble a blue, fluid, inky wash rather than a black through grey range. The light tobacco powder, though, fired to the expected muted

⁴¹⁹ See Chapter III – Ink > Colour and Chops

⁴²⁰ Please see firing schedule in Appendix V, Test #31



Figure 188 Nearly opaque cone, showing few brush and ink characteristics. Photo: Sheila Labatt



Figure 189 Truncated cone section revealing apparent wash and line imagery. Photo: Sheila Labatt

yellow/brown colour seen in certain, mostly non-literati, schools of Chinese landscape painting.

I arranged the triangular cross sections inside a new, plaster/silica/fibreglass, fan-shaped mould, ensuring that the inclusions would line up with each other to form an unbroken image [Figure 190].



Figure 190 Triangular sections in fan-shaped mould, arranged to form a 'wash' continuum. Photo: Sheila Labatt

The piece was then re-fired, with the result showing long, continuous, powerful lines and washes throughout the piece.⁴²¹ The veiling, in this piece is less evident than that in *Fan* [Figure 181] because it is obscured by the abundance of colour.

⁴²¹ See Appendix V, Test #36

f) *Flying White*

Flying White not only evokes the long, fluid, dynamic and graceful strokes of Grass script calligraphy, the lines also exhibit characteristics of 'flying white' strokes (飞白 fēibái) [Figure 191],⁴²² in which the brush is allowed to become slightly dry and the hairs allowed to split [Figure 35]. The vitality with which the flying white strokes are executed creates somewhat raw yet light, poetic and graceful lines.

In *Flying White*, these characteristics can be seen where the rhythmic, confident lines taper to a fine point. This brush technique is particularly evident in the large, diagonal stroke in the lower right-hand corner of the piece and conveys spontaneity and individuality.

The red line references Chinese chops.

Purpose and Process:

My purpose was to evaluate to what extent 'bubble running' could affect straight, non-flameworked inclusions and whether the manipulation of colour, under the effect of the bubbles alone, could effectively render the rhythmic and spontaneous characteristics of Grass script.



Figure 191 *Flying White*, 2013, Sheila Labatt, cast glass, 19x13x6cm, Photo: Sheila Labatt

⁴²² See Chapter III – Ink > Line > Chinese Calligraphy > Grass Script

In the first stage, I hot cast a rectangular block using refractory paper-lined kiln bricks and shelves as a mould. Between clear Glasma glass gathers, I placed lengths of slightly slumped, pre-heated cane pulled from Kugler Colours Opal Black (K095) and Imperial Red (K125A), width-wise, between two layers of molten glass. The block was then annealed at 500° for 12 hours [Figure 192].



Figure 192 Block showing lengths of cane sandwiched between hot cast gathers.
Photo: Sheila Labatt

In the second stage, I cut the block width wise into slabs, which I then drilled through with holes. I paid particular attention to drill through the blunt cane ends so that the bubbles would draw them into tapers during firing. I also made sure to cut the slices into different thicknesses, drill the holes in different diameters/volumes and place them in unrecognisable patterns [Figure 193]. This prevented line and bubble symmetry within the finished piece. As in Grass script, where no two characters are exactly alike, the inclusions are also designed to display non-uniformity of line weight, shape and distribution.



Figure 193 Arrangement of drilled segments back into a block for taping and re-firing.
Photo: Sheila Labatt

Following drilling and cutting, I thoroughly dried the block and reassembled and taped, to seal any gaps between the slabs and prevent investment material from entering the piece.⁴²³

The block was then fired to a top temperature of 850°, causing the holes to become bubbles in the molten glass and rise, dragging the straight cane

⁴²³ See Chapter V – Techniques Explored in this Project > Introducing Colour into the Glass > Trapping Colour Between Slabs.

inclusions to become smoothly-flowing, gestural lines.⁴²⁴

The result shows that the bubbles effectively altered the straight lines of the cane inclusions, creating apparently spontaneous, unconstrained line imagery, evocative of Grass script. I also noted that Kugler Colours' Imperial Red fired to a less vibrant hue than Gaffer's Vermillion cane inclusions, which were used for the other pieces.

This piece suffered an unfortunate rociprolap accident shortly after I had photographed Figure 191 for my records.⁴²⁵ The half-polished glass could not be cropped in any way that would have maintained a suitably balanced composition.

Since the lines in the heavily-chipped object read well, as apparently spontaneous, balanced, gestural and tapering calligraphy, I hoped that the piece could be salvaged. I theorised that melting it into a new mould, of a different size or shape, would retain these positive characteristics in a new piece, as I had done to excellent effect by re-firing *Da Shan Shui* 大山水 [Figure 168] to become *Tsunami* [Figure 169]. I therefore stood it in a new, cuboid mould, with ample voids into which the glass could flow [Figure 194], as I had done in the Bullseye tests in Figure 143.



Figure 194 Damaged *Flying White* ready for re-firing into a new form, with plenty of space inside the mould for the glass to flow. Photo: Sheila Labatt

My theory that a damaged piece with 'successful' inclusions could be re-fired into a new form to create different but equally successful inclusions had proven

⁴²⁴ See Appendix V, Test #22

⁴²⁵ A rociprolap is a motorised, precision-engineered, round, flat steel plate that vibrates as it turns. Using grit and water, a flat glass surface can be ground or polished while sitting on the plate as it turns, saving hours of hand polishing.

correct in the past.⁴²⁶ This time, however, it did not. The previously delicate inclusions became an uninteresting, solid black mass, concentrated in the centre of a block [Figure 195].⁴²⁷

Standing the original block on its end had meant that the inclusions were stacked vertically and, when molten, ran straight downward and on top of each other, resulting in the black mass. If I had instead laid the block flat inside a mould, some of the original characteristics might have been maintained.

Further investigation could prove useful for recycling unsatisfactory castings, over as many firings as necessary, until a better likeness of brush and ink painting is achieved.



Figure 195 Re-fired *Flying White* [Figure 191], shows no characteristics of the original inclusions. Photo: Sheila Labatt

⁴²⁶ See *Da shan shui* 大山水 [Figure 168] and *Tsunami* [Figure 169] in Chapter V – Techniques Explored in this Project > Manipulating Inclusions Three-Dimensionally > Bubbles in Kiln Casting

⁴²⁷ See Appendix V, Test #23

g) *Out of the Box III*

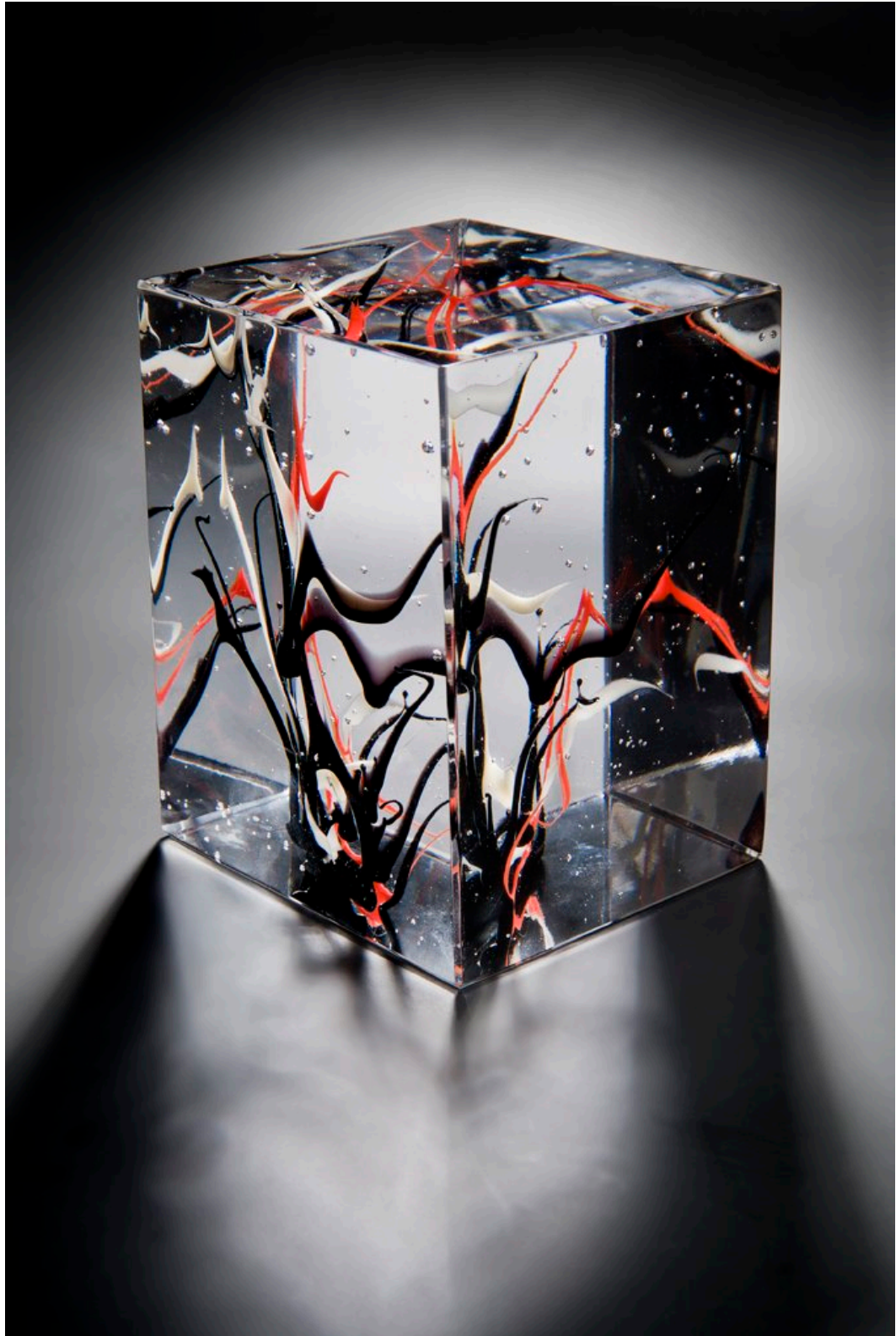

Figure 196 *Out of the Box III*, 2015, Sheila Labatt, cast glass, 15x10x10cm. Photo: Ester Segarra

Out of the Box III [Figure 196] evokes dynamic, Grass script calligraphy. The inclusions curve expressionistically, in all directions, and taper into long, balanced, heavily-saturated and graceful lines. Additionally, plenty of empty space is left inside the block, per Lao Zi's admonition to 'leave [space] blank',⁴²⁸ allowing the lines to dominate the design.

The refraction caused by the high polish and cuboid shape of this piece cause the lines to appear to repeat, giving an additional sense of rhythm, as is demanded of all good calligraphy.

The colours – black, vermillion and white – symbolise ink, chops and paper, respectively. They also add visual interest and invite one's gaze into, around and through the work.

Purpose and Process:

My purpose was to observe the effect of running bubbles, created by the chilled water-laden 'nail plunger' [Figure 155] in hot casting.

I placed flameworked Gaffer Black (G050), Vermilion (G176) and Ivory (G102) cane inclusions between gathers of Glasma furnace glass, into a plaster/silica/fibreglass mould, pre-heated in the kiln to 600°. Also, between each gather, I pushed the plunger into the molten glass to create divots by slightly chilling the hot glass' skin. The next gather covered the holes, leaving behind trapped air pockets, which would rise as bubbles once the kiln temperature was raised to 900°.⁴²⁹

The result shows saturated, gestural and apparently spontaneous ink-like line inclusions.

⁴²⁸ See Chapter III – Ink > Colour and Chops

⁴²⁹ See Appendix V, Test #59

h) *Parallax*



Figure 197 *Parallax*, 2013, Sheila Labatt, cast glass, Ø15x8cm. Photo: Ester Segarra

As part of this research, I explored using basic three-dimensional forms (cubes, cones, cylinders and hemispheres) to see whether they could enhance either the effects of the inclusions or the general interest of a piece. Although I had

greater success with cones and cuboid forms, *Parallax* [Figure 197] proved to be a happy accident, providing a new way in which inclusions can evoke a sense of movement by viewing them through random lenses created by bubbles.

Some of the bubbles in *Flying White* [Figure 191] remained trapped, inside the piece, as a component of the design, using a firing schedule designed to cut the heat before the bubbles had had time to escape. In *Out of the Box III* [Figure 196], I included no such constraints in the firing schedule, allowing the bubbles to fire out.⁴³⁰

In *Parallax*, bubbles remained on the surface of the work, neither fully inside the glass (as in *Flying White*) nor outside (as in *Out of the Box III*). These serendipitous surface bubbles, once ground in half, created irregular, organic concave lenses that gave the inclusions additional visual movement by disrupting the simultaneous view through the flat, polished surface [Figure 198].

In finishing *Parallax*, I sandblasted half of the top surface, to isolate the lenses through which to view the inclusions. When viewed through an isolated lens, on the sandblasted side, the fluid, calligraphic, heavily saturated ink-like lines are distorted and appear smaller and further away than they actually are [Figure 198, lower right]. These shallow, imperfectly hemispherical lenses, therefore, enhance the already graceful lines and tapers.



Figure 198 *Parallax* (detail), inclusions are distorted and appear farther away because of concave lenses. Photo: Ester Segarra

⁴³⁰ The largest bubbles, that would have formed part of the composition, fired out. Only a small number of 'seed' bubbles remained trapped inside the piece. Seed bubbles are tiny bubbles trapped inside glass. They are common and acceptable in cast 'art' glass but are usually considered a flaw in commercially manufactured glassware.

The polished half of the surface juxtaposes the views of the inclusions through a flat surface with that of the lenses, creating an intense sense of movement.

Contrasting a 'normal' view with one distorted by multiple lenses confuses the line continuation, through refraction, and adds additional rhythm. The polished half also engages the viewer by inviting them to look more deeply into the piece, under the edge created by the nearly opaque, sandblasted half.

The overall effect of *Parallax* is that it exhibits movement in the saturated, fluid 'ink' strokes, characteristic of Grass script. As with other pieces, it also adds a dimension of interest through the use of red to reference chops and the special occasion use of calligraphy on a red ground.⁴³¹

Purpose and Process:

My purpose was to create apparently spontaneous and gestural ink-like lines inside a hot cast glass hemisphere.

I preheated Gaffer Black (G050) and Vermilion (G176) flameworked cane inclusions (600°) and placed them, one at a time, into a preheated plaster/silica/Crystalcast mould (also 600°), between gathers of Glasma furnace glass, as was done in *Grass Script II* [Figure 172]. I simultaneously manipulated the inclusions with long tweezers to create additional movement and gesture. The kiln was then closed and the temperature raised and held at 720°, with the intention of allowing potential bubbles to fire out.⁴³²

The top temperature of 720° was either not high enough, or not held for long enough, to allow the bubbles to fire out, as they had done in *Out of the Box III* [Figure 196], which was fired to 900°, and soaked for two hours. Many large bubbles remained on the surface of this hemisphere [Figure 199].

⁴³¹ See Chapter III – Ink > Colour and Chops

⁴³² See Appendix V, Test #34

Whereas the bubbles in *Out of the Box III* [Figure 196] and *Flying White* [Figure 191] were created intentionally, the bubbles in *Parallax* were serendipitous. They might have been generated by stirring the glass, with tweezers, adding air pockets in the process. They might also have formed if the glass 'blank'⁴³³ had not been placed in the mould as a single, very hot and thermally homogeneous bolus. Its surface might have cooled slightly, causing a skin, which made the hot glass flow more slowly off the punty and into the mould. This would have caused the gather to double back on itself as it hit the bottom, trapping air in the process.⁴³⁴



Figure 199 Bubbles showing on surface of hemisphere after hot casting and prior to grinding. Photo: Sheila Labatt

I have been unable to consistently replicate this phenomenon which, if it were duplicable, could be used as another method of inserting large enough air pockets for bubble running.

In *Parallax*, I first ground off the tops of the surface bubbles [Figure 199] on a flatbed,⁴³⁵ retaining the bottom halves as convex lenses. I then polished the uppermost surface, leaving it, and the lenses, glassy. (The lenses themselves were already fire-polished because they had formed inside the bubbles.)⁴³⁶

⁴³³ A 'blank' is molten glass, gathered on a punty or blow-pipe and ready to be worked.

⁴³⁴ A damp mould could also have caused bubbles such as these but, in this case, the mould had been drying for over a week and probably had no water residue left.

⁴³⁵ A flatbed is a precision-engineered, flat, horizontal, rotating steel wheel head. It is used to grind glass, using either silicon carbide abrasive grits (SiC, also known as carborundum) or diamond-encrusted interchangeable discs. It is always used with a slow stream of flowing water to keep the glass from overheating and cracking, due to friction.

Post polishing, I taped half the surface that was to remain shiny and filled the lenses with white PVA glue, allowing it to harden. These formed a resist that isolated and protected those areas when I then sandblasted the other half of the surface. I later peeled off the tape and soaked the piece to remove the glue, leaving those places polished and the rest etched and translucent.

The finished piece creates a parallax, in which the inclusions' sizes, shapes and locations appear to change, depending on sight-lines. Not only do the manipulated, frameworked inclusions provide a sense of freely executed brush and ink strokes, as in *Grass Script II* [Figure 170], but the irregular, concave lenses left behind by the bubbles create additional visual movement in the black and red inclusions.

When viewed through the lenses in the sandblasted half, the lines distort differently as the viewer moves around the piece. This provides a sense of vigour, as if inclusions were freely executed Grass script calligraphy.

When seen through the polished half, even more line distortion occurs. The flat, glassy surface provides a view of the expressionistic inclusions as they are. In addition, viewing the inclusions through the combination of the flat surface and the lenses confuses the eye, which must simultaneously negotiate between full-scale and distorted, distant-feeling inclusions. This effect is augmented as one moves around the piece. Finally, curiosity calls upon the viewer to enter the work by peering under the sandblasted line to discover calligraphic lines that are obscured by the rough, milky surface.

⁴³⁶ Firepolished glass has been rendered 'glassy' through the application of heat, which melts the surface of the glass and causes it to become smooth and 'polished'. Blown glass is therefore always 'firepolished'.

i) *Bonzai*

For *Bonzai* [Figure 200], I sliced a clear block into slabs, drilled through the



Figure 200 *Bonzai*, 2013, Sheila Labatt, cast glass, 10x7x7cm.
Photo: Ester Segarra

centre one and added a sparing amount of black ceramic enamel powder between the layers. As in other pieces using light applications of black, such as *Wash IV* [Figure 177], the 'black' ceramic enamel reads as blue ink in the finished piece.

Unlike *Wash IV*, however, in which powders were used to produce fields of ink-like wash, *Bonzai* evokes the delicate, meticulous lines that can be seen in *Willow Tree* [Figure 201].⁴³⁷ *Willow Tree* is also an example of how Chinese painting, calligraphy and poetry (the 'Three Perfections')⁴³⁸ cohabit a work, in perfect balance.⁴³⁹



Figure 201 *Willow Tree*, 1754, Jin Nong, ink on paper, 'bird and flower' ink painting on paper, showing delicate branches and leaves that appear in traditional landscapes, 25x32cm. Collection: Tianjin Municipal Art Museum, Tianjin

Bonzai was designed to be a vertical landscape, as is seen more often in Chinese than in Western landscapes.⁴⁴⁰ It displays line and minimal wash imagery, which is well balanced within its three-dimensional space, as *Willow Tree* is, on the two-dimensional picture plane. Both works are well composed in terms of positive and 'leaving blank' space, allowing the image to breathe, while still commanding the frame as a whole. As in *Willow Tree*, *Bonzai*'s lines read as dynamic, gestural and assured brush strokes and exhibit a soft, balanced and poetic delicacy, with the points on their tapering ends highlighted by a trapped bubble.

Purpose and Process:

My purpose was to examine whether bubbles, run through a disciplined, geometric design such as a grid, can nevertheless yield organic, apparently spontaneous ink-like lines.

⁴³⁷ *Willow Tree* is a 'bird and flower' painting rather than a landscape. I have used it here, though, to illustrate the detailed brushwork in Chinese landscapes, that must be seen up close and cannot be reproduced clearly enough here.

⁴³⁸ National Palace Museum, Taipei, 'Chinese Painting', *China Online Museum*, 2017 <<http://www.comuseum.com/painting/>> [accessed 23 July 2017]

⁴³⁹ See Chapter III – Ink > Colour and Chops

⁴⁴⁰ See Chapter III – Ink > Wash > Landscape

The piece began with a block of hot cast Glasma glass. Unlike with other 'bubble running' pieces in this section, such as *Flying White* [Figure 191], I initially hot cast this block without colour inclusions. Instead, I hot cast it clear; black powder was added at a later stage.

The second stage of the process was similar to that used for *Flying White* in that I cut the block into three slices, using a diamond saw and water. I drilled a single hole through what would be the centre slice, to create a relatively large bubble, which would drag the minimal application of colour during kiln casting.

I then painted black ceramic enamel, suspended in acrylic medium, into the depressions of a shallow, sandblasted grid, on the surface of each slab, to determine whether such a light application of colour would be sufficient to travel the length of the piece [Figure 162].

I reassembled the block so that the enamel powder would be trapped between the slabs, with the drilled one sandwiched between the other two [Figure 202], before taping the reassembled block so that no investment could leak between the slabs.⁴⁴¹ It was then fired.⁴⁴²

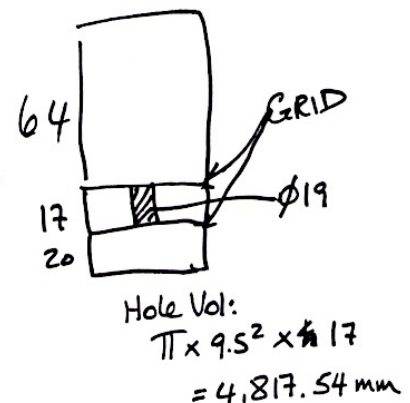

Figure 202 Assembly and orientation of elements, showing location of drilled hole, sketch from studio notes

The result shows that running bubbles through the geometric symmetry of the black powder grid lines distorted the lines enough to yield an asymmetrical, yet loosely organised, apparently spontaneous and gestural image, three-dimensionally, inside the glass. The large bubble had moved the lightly applied powder inclusions around and throughout the full length of the piece and produced thin, graceful, curving lines.

⁴⁴¹ See Chapter V – Techniques Explored in this Project > Introducing Colour into the Glass > Trapping Colour between Glass Slabs

⁴⁴² See Appendix V, Test #13

The primary bubble fired out of the glass. Infinitesimal air pockets trapped amongst the fine grains of the ceramic enamel powder, in grooves of the grid, formed smaller bubbles which floated upwards inside the glass. Unlike the large bubble, they remained trapped inside the piece and evoke raindrops falling from delicately suspended willow branches.

j) *Krakatoa*



Figure 203 *Krakatoa*, 2013, Sheila Labatt, lead crystal, 27x19x8cm.
Photo: Xiao Jin

Finally, *Krakatoa* [Figure 203] was an effort to apply the techniques I had developed, using Glasma blowing glass, to lead crystal (of unknown origin, which I had found behind a Chinese glass factory), using bubbles to manipulate coloured powder inclusions. As in *Bonzai* [Figure 200], I did not begin the piece

with hot cast inclusions. I kiln cast it in two stages: first, as a clear glass block and, in the second stage, introducing black powder between cut slabs. Like *Bonzai*, I designed this piece to evoke vertical Chinese landscapes.

Krakatoa exhibits dark, dramatic ink-like wash and line imagery of the kind seen in literati landscapes. The crisp contours and intense saturation evoke the power and majesty of nature. The tonality range also demonstrates the Five Colours of Black and creates a sense of perspective, with the lighter wash applications, in landscape painting and in this piece, appearing to recede in space.⁴⁴³

Many landscapes illustrate large-scale, sweeping 'wide-angle' narrative scenes of rounded mountains, villages, people and sky [Figure 37]. In contrast, *Krakatoa* recalls the many depictions of the sheer, iconic Mount Huángshān [Figure 3], which inspired this research.

The ink-like washes in *Krakatoa* appear in a variety of densities along the dark to light spectrum, where the colour at the lighter end of the scale has remained grey, unlike the blue, seen in *Wash IV* [Figure 177] and *Bonzai* [Figure 200], which were fired hotter, using furnace glass. Further research is needed to determine whether the colour difference is a function of heat, brand or type of glass.

In *Krakatoa*, the trapped bubbles evoke not only the water component of the Chinese term for landscape painting but also a volcanic eruption, because they are centred directly above the 'mountain' component of the image.

Purpose and Process:

My purpose was to run bubbles through powder inclusions on a larger scale than in *Bonzai* [Figure 200] and to evaluate the qualities of colour and bubbles

⁴⁴³ The dark/light wash application method is one of the 'perspective' techniques taught in brush and ink painting, rather than linear perspective, to achieve depth of field.

in lead crystal. I also hoped to create a 'landscape' inside an exceptionally clear piece, which would yield a dramatic ink wash effect, without the distracting veiling that can occur with cast blowing glass.

The technique used for *Krakatoa*⁴⁴⁴ was inspired by the bubble-running/grid process, employed for *Bonzai*.

I cut a pre-cast, clear block into six slabs. One surface of each slice was then carved with a 4mm deep grid on a diamond saw. Using a plastic palette knife, I half-filled the cuts with heavily saturated Opal Black Kugler Colours (K095) powder, suspended in acrylic impasto medium. I only half-filled the grooves in order to trap air that would become bubbles inside the molten glass.

I also heavily coated the rest of each surface with the mixture [Figure 204]. Once all surfaces were dry and the impasto had hardened, I reassembled the slabs so that the intended top of the finished piece sat at the bottom of the stack because the mould would be inverted for firing. I wanted a large negative space at the top, to emulate sky, so the thickest piece of glass was placed on the bottom. I also hoped that, through the design of the firing schedule, bubbles would become trapped inside that clear portion of glass and



Figure 204 Preparation of glass slabs, filling grids (top right) and coating remaining surfaces with glass powder and acrylic impasto medium mixture. Photo: Sheila Labatt

⁴⁴⁴ See Appendix V, Test #17

form 'water' imagery within the overall composition. (I had not, though, imagined that they would all be concentrated in the upper centre – one of the happy accidents that can occur when control and chance work together.)

Once I had reassembled and sealed the block, I lowered a single-use, mild steel box [Figure 205] around the block, in lieu of cottling boards, which are used for lighter pieces or shorter moulds.⁴⁴⁵ This piece weighed 20 kg – before I cut it to the present dimensions [Figure 203, 27x19x8cm], for compositional reasons – and would have broken an unsupported plaster/silica mould when the crystal was molten. I therefore poured a plaster silica refractory mould around the block, inside the box; this provided the necessary support for the molten glass, which would exert a large amount of downward and outward pressure on a piece of this weight and height.⁴⁴⁶



Figure 205 Welded, single-use, mild steel box used to support the mould and heavy molten lead crystal. Photo: Sheila Labatt

The result shows strong, saturated and well-defined ink line and wash effects. The air trapped in the deep grooves of the grids became bubbles that travelled a long distance inside the block. They effectively moved the colour upwards through the piece, creating a strong sense of movement. Due to the high lead content of the crystal, the negative spaces remained exceptionally clear and showed no cording or veiling, which enhances the saturation of the 'ink wash'.

Although I was pleased with the imagery inside the work, I noted that many small bubbles had travelled up and along the exterior of the piece because the grid cuts had extended to the edges of each slab. The air had, therefore, not been fully contained inside the block. These broken surface bubbles could not

⁴⁴⁵ Cottling boards are erected around the area into which refractory material will be poured, to contain the liquid until it has set.

⁴⁴⁶ See Appendix V, Test #17

be ground out because new ones, located throughout the piece, would have risen to the surface in their place. Unintended, concave 'half-bubbles', therefore, remain on the four vertical, highly pitted surfaces of the piece.

VII CONCLUSION

1. Thesis

This project was inspired by my 20-year fascination with Chinese brush and ink calligraphy and traditional landscape painting, as viewed through Western eyes. It was also influenced by a decade of inquiry into manipulating inclusions inside clear, cast glass. My research explores technical processes for imbuing cast glass with a sense of spontaneity that is made visible in ink-like inclusions. It therefore comprises both technical research and aesthetic goals.

Casting is a long, involved, 'staccato' process that does not lend itself to the immediacy of artistic expression available to glassblowers. I have therefore developed hybrid processes that use voids to act on molten glass, causing it to flow. This movement, in turn, acts on inclusions that reflect the nature and extent of the displacement once the glass has solidified.

The aesthetic aim of my research is for those inclusions, manipulated by flowing glass, to evoke spontaneously-executed Chinese Grass script calligraphy and traditional landscape painting. My intention is not to replicate these genres but to evoke their line and wash characteristics, in the third dimension.

In Chapter II, I establish the scope of the project by defining a key element in its title: the glass casting process. My research revealed that there is no consensus among glassmakers as to an exhaustive meaning of casting. Some believe that glass must be fully liquid and others maintain that fused and slumped objects can also be considered to have been cast.

The research also indicated that a cast glass *object* cannot be defined either in terms of its weight or mass. Nor can the casting *process* be defined by temperature. The only consistent opinion is that a mould is required and I discovered there is no agreement as to that definition, either.

In Chapter II, I therefore arrive at a working definition for the purposes of the project: a mould must be a hollow *form*, rather than a tool or action (such as using jacks and a paddle in the hot shop), which completely contains molten glass, allowing it nowhere else to go. This in turn defines the casting process and establishes a key technical parameter for the studio research.

I used multiple processes to create each piece. In Chapter II, I therefore further refine the casting definition to address its role within a sequence of techniques. To deem a piece cast for the purposes of this research, casting (as I have defined it) must be the last hot process used to create the work. Coldworking does not form part of the casting process and is, therefore, not discussed.

Spontaneity is also fundamental to this research and is addressed in Chapter II. My research showed that spontaneity is difficult to understand in the cast glass context. Neither dictionary definitions nor the butterfly effect in Chaos Theory (Gleick) are adequate to describe the aesthetic aim of the research. In fact, they led me to believe that nothing is truly spontaneous.

Still, I assembled satisfactory elements of otherwise inadequate dictionary definitions to help describe and evaluate the spontaneity of inclusions inside cast glass: They must demonstrate an open, natural and uninhibited aesthetic, which has occurred without apparent external cause and without being tended or cultivated. They must *appear* to have arisen of their own accord.

In Chapter II, I also compare Csikszentmihályi's Zone theory to the ancient Daoist philosophy of wúwéi (无为); doing by not doing. Both describe a state in which an artist is so focused on their work that it flows effortlessly. Csikszentmihályi believes that this state brings fulfilment in the form of ultimate happiness. In contrast, wúwéi speaks to the quality of one's character and requires that a person in the state of wúwéi radiates virtue, or dé (德). Despite this important difference between the two philosophies, both the Zone and wúwéi describe a sense of effortlessness in one's work, which translates into the intangible aesthetic qualities that I seek to evoke in flowing, ink-like inclusions.

Whereas the Zone and wúwéi describe spontaneity and flow within the creative process, the Japanese philosophy of shibusa (渋さ) concerns objects themselves. It defines 'ultimate beauty' as lying on an 'exuberance to restraint' continuum, closer to the restraint end. More importantly, shibusa (sometimes referred to as restrained spontaneity) describes two types of spontaneity: that of action and that of effect. I view these as true spontaneity (to the extent that that exists) and apparent spontaneity, respectively.

I not only evaluate the inclusions in this project in terms of my own definition of spontaneity, I also conclude that the inclusions should bear a *likeness* (spontaneity of effect/apparent spontaneity) to brush and ink painting that has been executed by an artist in the Zone or in a state of wúwéi.

Chapter III describes other criteria for evaluating apparent spontaneity in the project: characteristics of Chinese brush and ink painting.

The chapter begins with a brief look at Chinese artists who have broken with painting tradition in terms of the materials they use and the messages they deliver. I then explain those traditions with a view to identifying line characteristics of Grass script calligraphy and those of ink wash in traditional, mostly literati-style landscape painting.

Good quality, traditional Chinese painting tools, which have not changed in millennia, are needed to create these distinguishing features of Chinese painting. I therefore introduce the Four Treasures of the Study: the round, finely-tipped brush that holds large amounts of ink and can create every type of stroke and wash using only one brush; the fine, highly absorbent xuān paper that allows for rapid brush strokes, of all intensities, without allowing the ink to bleed. I describe the ink stick and ink stone, for grinding liquid ink more briefly because they create subtle effects that are not visible in glass inclusions, particularly paint quality. The importance of these last two 'treasures', though,

is that serious artists consider the ink grinding process essential to their mental preparation for painting, in the hope that they will enter the state of wúwéi.⁴⁴⁷

The spontaneous inclusions sought in the project are intended to evoke Grass script calligraphy lines. This is the most difficult script to write (and read), requiring years of practice to do so. In this chapter, I describe Grass script using illustrations to distinguish it from the highly-structured Standard script, of which Grass script is an extreme abstraction.

Grass script characteristics define the aesthetic desired in the inclusions in this project: quickly and spontaneously executed, fluid, dynamic and expressive lines. The brush rarely leaves the page creating long gently curving and tapered lines that vary in weight, energy and rhythm. Even the ink content of the brush varies, to create 'flying white' strokes.

In Chapter III, I also explain the qualities of ink wash that are important to this research. Specifically, the highly-regarded Five Colours of Black (墨分五色 mò fēn wǔ sè) in which the full range of tonal values and brushworking techniques inhabit the same work, as can be seen in Huang Binhong's dramatic landscapes.

In connection with landscape painting, I briefly address colour, in that it is used in some schools of landscape painting. These muted colours (including 'grue') are used sparingly and considered the guests of the painting and not the hosts. The vermilion chop (seal), seen in all forms of Chinese painting, is also mentioned. I use both the muted colours and the vermilion in certain pieces, alongside the inclusions that evoke ink wash.

The most important 'colour' in Chinese landscape painting is no colour at all; the paper is left blank. This important principle is rooted in Daoism, which

⁴⁴⁷ Although coldworking is not discussed in this thesis because it is not strictly part of the casting process, certain long, repetitive coldworking techniques like grinding and polishing glass can, similarly, put one's mind into the Zone or into a state of wúwéi.

compares the empty space between heaven and earth to a bellows that is empty yet does not collapse. It also derives from Zen Buddhism, in which the Paramita Hridaya Sutra teaches that form does not differ from emptiness, nor emptiness from form. In evaluating my work, I therefore consider a good balance between 'ink' and blank spaces to be important.

The inclusions in this project are intended to reinterpret two-dimensional painting in the third dimension. In Chapter III I address the difficulty of describing the third dimension in art, particularly in pieces where an object is encased in a solid, clear medium, such as glass. According to Abbott the only method for establishing the third dimension is through touch, and Kant believes that one must rely on 'pure intuition'. Touch is unavailable for assessing the dimensionality of inclusions and intuition is too subjective to establish the success of the work. I therefore review basic mathematical principles and establish my own, more objective rules for confirming the dimensionality of inclusions. I consider them three-dimensional if they are readable from all angles as a series of receding two-dimensional planes (they exhibit depth of field) and from no angle as a unidimensional line, however thick. By this definition, therefore, even large extrusions such as Robert Indiana's *LOVE* sculpture, are two-dimensional.

Chapter III concludes by assuming that the sense of touch is unavailable and applying my definition of the third dimension to ostensibly three-dimensional works that resemble Chinese painting. This exercise was intended to contextualise my work in glass and revealed that Grass script calligraphy and traditional landscape painting are not easily rendered in the third dimension.

Chapters II and III address key aspects of this research: the casting process, spontaneity and ink in the third dimension. The remaining element in the project's title is glass.

Chapter IV explains aspects of ancient and Qing Dynasty glass history because they had a direct impact on contemporary Chinese glass. These historical periods in Chinese glassmaking have also influenced my own work, since I

learned glassmaking in China, as one of the early members of the Chinese Studio Glass movement.

The chapter surveys glassmakers who use bubbles or voids in kiln forming and others who have explored ink, calligraphy or landscape, mostly in cast glass. I also contextualise their work in terms of flow, spontaneity and wúwéi, cross-cultural inspiration, the Daoist and Zen principles of 'leaving blank', language and communication and dimensionality.

In Chapter V, I provide detailed, illustrated explanations of the glassmaking techniques that I researched in this project, including: the types of glass used, three ways of introducing colour into the glass, using voids (including bubbles) to create flow and to manipulate colour, in both hot and kiln casting. These techniques were used, in different combinations, in the creative output of the research.

Finally, Chapter VI contains images showing selected results of the research and includes detailed technical information for each piece. I discuss each piece in terms of flow and apparent spontaneity, as defined in Chapter II – Casting, Spontaneity and Flow. I also address the ability of each piece to evoke elements of Chinese Grass script calligraphy and literati landscape painting characteristics that I identified in Chapter III – Ink.

2. Contributions to Knowledge

a) *Introduction*

The hybridity and order of techniques used in this project form the basis of my original contribution, particularly in the way they achieve the aesthetic aims of the project: rendering Chinese ink painting characteristics.

b) *Aesthetic*

The difficulty in controlling glass flow, using bubbles and voids, means that each piece generated by this research is unique and an original contribution in the field of cast glass.

For over 50 years, Chinese artists have been challenging painting traditions through abstraction, new media and by addressing social and political concerns. Relatively recently, one of those media has been glass.

Several Chinese studio glassmakers have been exploring ink, calligraphy and landscape painting in casting, pâte de verre and flameworking. My work broadens this exploration by using flow and three-dimensional inclusions to emulate the spontaneity of brush and ink painting. The work contributes an original aesthetic to the reinterpretation of these ancient fine art traditions, whether in glass or otherwise.

c) *Technical*

The techniques that contributed to this research are well known among glassmakers. However, the hybridity and strict order in which I apply these processes, to specific aesthetic ends, are not, and contribute to original knowledge in the field of cast glass.

In addition, although each finished piece is unduplicable, the techniques that I used to create each one are replicable, based on the data I have provided in Appendix V, enabling further original research to be undertaken.

d) *Linguistic*

Glassmakers agree that casting involves liquid glass that takes on the shape of a mould. Although many believe this to be the only meaning of casting, my research revealed that others include additional glassmaking techniques, such as fusing and slumping, within their understanding of the term.

Comprehensive definitions of casting, moulds, spontaneity and the third dimension were essential to establishing the technical and aesthetic parameters of this project. I therefore considered a variety of views regarding each of these terms and arrived at a sufficiently exhaustive working definition for each one, providing original contributions to glass nomenclature:

- Casting: creating a three-dimensional object by means of a mould.
- Mould: a hollow form, rather than a tool or action, which completely contains molten glass, allowing it nowhere else to go.
- Spontaneity: inclusions must demonstrate an open, natural and uninhibited aesthetic, which has occurred without apparent external cause and without being tended or cultivated. They must *appear* to have arisen of their own accord.
- The third dimension: inclusions must be readable from all angles as a series of receding two-dimensional planes and from no angle as a unidimensional line, however thick.

I expect there to be differences of opinion regarding my reasoning and, therefore, these definitions. I believe, though, that they will stimulate discussion in certain instances, such as when authoring books or dictionaries, curating (cast glass) exhibitions or when assessing the dimensionality of intangible objects.

3. Further Investigation

The results of this research warrant further investigation on five fronts: identifying colour recipes and temperatures that prevent glass powders from turning blue, scaling up the work, exploring methods for creating large surface bubbles that can be ground off to create organic lenses that distort inclusions, using flower pots to induce flow and extrapolating technical information from the present research to further the work, in lead crystal.

First, commercially-available and custom colours need to be tested with different brands and recipes for clear glass, to find combinations that retain the 'blackness' of Chinese ink, if that is one's aim. This has proven difficult when light applications of black glass powder created blue or purple 'ink' washes. Compatibility and flow qualities also need to be considered.

Secondly, scaling up the work is a logical next step. It would allow bubbles to travel further within the work, creating longer, more gestural-looking lines, just as gestural drawing has more impact at scale. Scaling up the work is not as simple, though, as using identical processes to create bigger pieces. Working with more glass requires stronger moulds. Research should begin with testing commercially available investment materials and the recipes described in Angela Thwaites' extensive study. Additionally, scale can affect colour density, which should be also taken into consideration when designing a work.

Thirdly, during the project, large surface bubbles were serendipitously generated in some pieces and I ground off their tops to create irregular, organic lenses. These concave lenses gave the inclusions additional visual movement, enhancing the dynamism of Grass script calligraphy. Flow and bubble work rely on a balance of control and chance and are never entirely predictable or replicable. However, a comprehensive investigation into generating large surface bubbles could yield somewhat predictable, compelling results.

During this project I briefly but unsuccessfully began to explore another method for inducing flow. This well-known technique involves suspending a flower pot above a mould and allowing molten glass to flow through the hole on the bottom of the pot and into a mould. I attempted to use this method to imbue cast pieces with gestural, brush and ink-like Grass script characteristics but ended up with a mess of uncontrolled (as distinct from spontaneous) colour. The properties of glass dictate that these characteristics should be achievable using this technique, and further investigation into firing schedules, as well as the reservoir and mould shape and set-up, will lead to exciting (though as yet unpredictable) results.

Finally, I intend to extrapolate the results of this research for use in larger, lead crystal pieces, which I believe is an exciting next avenue of investigation. My preliminary tests indicated that crystal flows more easily and yields far better optics than furnace glass: it is clearer, shows no cording and hardly any veiling. A higher index of refraction also creates more vibrant colours and causes bubbles to 'sing'. An additional benefit is that the glass powder retained its full greyscale, even where it had been thinly applied. The reason for this is unclear but it could be that the crystal I used interacts differently with the colour (or its brand) or because the lower temperatures required for crystal to liquefy might affect colour differently. Whatever the reason, making large, lead crystal objects based on the techniques identified in this research is my ultimate goal for further exploration.

APPENDIX I DATES, ROMANISATION AND NAMES

In China, Imperial-era art is described in terms of the Dynasty, during which a style was developing or an artist was active, rather than as a genre, as art is chronicled in the West. For instance, the Song Dynasty (960–1279), is considered a golden age of Chinese culture in which landscape painting developed dramatically under the *literati* (elite, highly-educated bureaucrat-scholars), whose expressive style diverged from the rigid, formulaic techniques of ‘court’ or ‘academic’ painters.⁴⁴⁸

Since the overthrow of the Qing Dynasty (1644–1912) – the last Imperial Dynasty – non-traditional art-forms (like acrylic or oil painting on canvas, referred to simply as ‘Western painting’) have become classified by genre or movement, such as Socialist Realism, as they would be in the West. Contemporary calligraphy and landscape paintings using traditional media (ink on paper or silk), though, have no such classification system and are simply designated ‘contemporary’. I therefore refer to post-revolutionary ink works by artist and date, rather than by Dynasty or genre.

Chinese words in this thesis are written according to the *pīnyīn* romanisation system. Pīnyīn is not difficult to read but requires some training to do so since pīnyīn letters do not always correspond, in sound, to their English counterparts. For example, *qi* and *xi* in pīnyīn are pronounced *chee* and *shee*, respectively, in English.⁴⁴⁹ Pīnyīn is now the official system in Mainland China and Taiwan and is accepted as the international standard for the romanisation of Mandarin. It is also used for teaching Mandarin because it adheres most closely to Mandarin phonology. Additionally, pīnyīn has become widely used in recent years because it is used to type Chinese characters on computers, meaning that school children are now taught pīnyīn in addition to Chinese characters.

⁴⁴⁸ See Chapter III – Ink > Wash > Introduction.

⁴⁴⁹ I also use Korean and Japanese words in this thesis. The Korean romanisation system is the ‘Revised Romanisation of Korean’ and the current Japanese system is ‘Hepburn’.

In certain cases, familiar romanised spellings date from an earlier system, known as Wade-Giles, which was supplanted by pīnyīn in the 1950s. Spellings based on the Wade-Giles system, for instance, include Mao Tse-tung, Ch'ing (Dynasty) and ch'i (the life force that flows within all living things). Those words are now spelled Mao Zedong, Qing (Dynasty) and qì, respectively and might be unfamiliar to readers. I therefore indicate the Wade-Giles spelling for older, commonly-understood words in the West the first time those terms are used in this thesis.

Additionally, pīnyīn words include diacritic marks. These are not accents, as in French. They represent the four tones used in spoken Mandarin to disambiguate homophones. For instance, mā, with a high flat tone (first tone), means mother, whereas mǎ, with a falling then rising tone (third tone) means horse. When used in pīnyīn, the diacritics assist students of Mandarin with the correct pronunciation.⁴⁵⁰ Although these marks are not usually used outside the teaching environment, I use them in the thesis to assist non-native Mandarin-speaking readers with further inquiry.

I use simplified Chinese characters for the same reason. These characters were developed in the 1950s to help combat illiteracy on the Chinese mainland⁴⁵¹ and were created (in many cases) by abstracting the more complex traditional characters, which are still used in Taiwan and Hong Kong. For instance, the traditional character for book is 書 (shū) and its simplified version is 书 (also shū).

Finally, a word about people's names: in China, one's name begins with the family name and the given name follows, which is the reverse of how names are recorded in the West. This complicates references to Chinese names in this

⁴⁵⁰ The diacritic marks used in pīnyīn simulate the tones' inflection: First tone, high and flat, marked with a macron (¯). Second tone, rising, marked with an acute accent (´). Third tone, falling then rising, marked with a caron (ˇ). Fourth tone, falling, marked with a grave accent (`).

⁴⁵¹ As distinguished from 'Greater China', which officially includes Taiwan, Hong Kong and mainland China according to the One-China policy, although Taiwan's status on the international stage is controversial.

thesis because certain names, such as Ai Weiwei and Mao Zedong are recognised in the West in their Chinese form, whereas others' names are understood in their (reversed) English form, in the West. In addition, Chinese name order is used differently by different people in different contexts. For consistency, therefore, I have used the Chinese format throughout this thesis.

APPENDIX II AMORPHOUS SOLIDS AND TEMPERATURE

Glass is an amorphous solid (rather than a supercooled liquid, as it had been previously characterised)⁴⁵² without crystalline structure, whose bonds are nevertheless strong enough to hold the material together.⁴⁵³ As such, there is no specific temperature at which glass changes from solid to liquid, as there is with metals or with water.

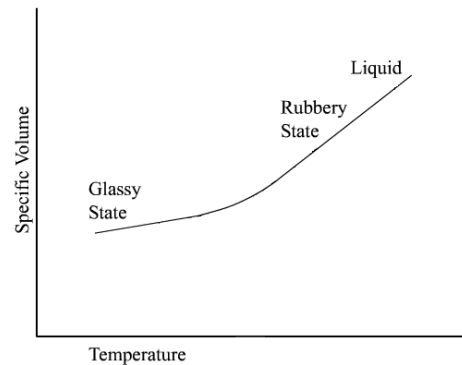

Figure 206 Curved continuum, graph showing the temperature relative to specific volume of a given glass, in relation to its viscosity. Source: Steven Weinberg

The melting *point* is in fact a transition *process* during which glass softens as it heats, on a curved continuum (based on temperature relative to the specific volume⁴⁵⁴ of a given glass, in relation to its viscosity) until it is fully liquid [Figure 206]. For those reasons, temperature considerations play a role in how I define ‘casting’.

⁴⁵² Gulbiten, Ozgur, John C. Mauro, Olus N. Boratav, and Guo Xiaojun, ‘Viscous Flow of Medieval Cathedral Glass’, *Journal of the American Ceramic Society*, 2017, 1–7
<http://onlinelibrary.wiley.com/doi/10.1111/jace.15092/epdf?r3_referer=wol&tracking_action=preview_click&show_checkout=1&purchase_referrer=onlinelibrary.wiley.com&purchase_site_license=LICENSE_DENIED> [accessed 27 November, 2018]

⁴⁵³ Proponents of glass being a supercooled liquid cite the fact that in old stained-glass windows the glass seems to have flowed downwards, with gravity, over time. The more probable argument, though, is that glass does not flow at all, at room temperature, and that window glass of old was never smooth or even to begin with. Since perfectly flat and even ‘float glass’, used in windows today, was not available at the time, old window glass had to be made by cutting large bubbles of blown glass and allowing the glass to relax into flat sheets. This glass was always installed with the thicker, thus heavier, part of the glass towards the bottom of the pane, making it seem, centuries later, that the glass ‘flowed’ downwards. See: Phillip Gibbs, ‘Is Glass Liquid or Solid?’, *The Physics and Relativity FAQ*, 1997
<<http://math.ucr.edu/home/baez/physics/General/Glass/glass.html>> [accessed 6 August 2017]

⁴⁵⁴ Specific volume refers to the number of cubic meters occupied by one kilogram of a material and is usually expressed in kg/m^3 .

APPENDIX III PATE DE VERRE AS FUSING

Pâte de verre (French for ‘glass paste’), is an ancient Egyptian process that was revived by French Art Nouveau glassmaker Henri Cros (1840–1907) and others.⁴⁵⁵ In this kiln-forming technique, *frit*⁴⁵⁶ is mixed with a binder⁴⁵⁷ and is usually applied to the inner surface of a mould. (It can also be used to fill a mould or laid on a flat surface.) It is then fused, to create fragile, hollow pieces [Figure 207] or more robust (even solid) ones [Figure 208].



Figure 207 *Green Amplexor*, 2011, Alicia Lomne, fragile and hollow *pâte de verre*, fused glass frit does not flow freely, 21x15x17cm. Source: alicialomne.com/



Figure 208 *Mother Earth*, nd, Kimiaki and Shin-Ichi Higuchi, *pâte de verre*, hollow yet robust, 71x34x34cm. Source: <https://www.cmog.org/bio/kimiake-higuchi>

There is no universal definition for *pâte de verre*.⁴⁵⁸ It has been defined in various ways, which have evolved over time, and is also described differently, according to geography. Sometimes, texture is a factor. Max Stewart, for instance, suggests that the surface quality of a finished piece – translucent and

⁴⁵⁵ Other prominent French and Belgian glassmakers re-exploring *pâte de verre* were Albert Dammouse (1848–1926), Georges Despret (1862–1952), François Décorchemont (1880–1971), Amalric Walter (1859–1942) and Jean-Gabriel Rousseau (Argy-Rousseau) (1885–1953).

⁴⁵⁶ Crushed, irregularly-shaped glass pieces, in sizes that range from powder to around 6mm.

⁴⁵⁷ Commercially available *pâte de verre* liquids, gum arabic or even diluted, ordinary white glue can be used. In China, rice gluten is used.

⁴⁵⁸ Frantz, S. K., *Pâte de Verre: The Beautiful Conundrum*, p. 24

sugar-like versus one that ‘allows light to penetrate to the heart of the object and through to the other side’ – should be considered in the discussion as to whether pâte de verre is a form of casting.⁴⁵⁹

My research indicates that pâte de verre is most often referred to as a type of casting,⁴⁶⁰ sometimes as fusing and,⁴⁶¹ on at least one occasion, as ‘a technique unto itself’.⁴⁶²

Keith Cummings refers to pâte de verre as casting throughout his widely read book *Techniques of Kiln-formed Glass* but cautions:

Although objects that fall into the pâte-de-verre category are cast, because the glass is given its form by its refractory mould, they would be more accurately described as fused... [because] the glass grains do not move an enormous amount...⁴⁶³

Helga Watkins Baker best summarises the case for pâte de verre as a fusing technique and explains the discrepancy in definitions:

Pâte de verre is a form of fusing as opposed to casting glass, as the particles of glass do not reach a temperature where they flow into the mould but are held in place by the [...] binder, in order to fuse together.⁴⁶⁴

My view is that pâte de verre falls squarely within the realm of fusing. As Cummings says, the ‘glass grains do not move an enormous amount’, if at all.

⁴⁵⁹ Stewart, Max D., ‘The Sense of My Screaming Skin: An Investigation into the Colouring Process of Amalric Walter (1870–1959) Using Metallic Salts in Pâtes-de-Verre.’ (PhD Thesis, Edinburgh College of Art, 2010) p. 89

⁴⁶⁰ Cummings (2007), Montouchet Zoritchak, Catherine, ‘Stages pâte de verre’, *Art du verre* <<http://www.catyzo.com/stages-verre/stage-pate-de-verre.htm>> [accessed 17 January, 2017]

⁴⁶¹ Diana Hobson in Cummings (2007), p. 18

⁴⁶² Philppa Beveridge, Ignasi Domenech, and Eva Pascual, *Warm Glass: A Complete Guide to Kiln-Forming Techniques: Fusing, Slumping, Casting*, trans. by Eric A. Bye (New York: Lark Books, A Division of Sterling Publishing Co. Inc., 2005), p. 114

⁴⁶³ Cummings (2007), p. 109, 111

⁴⁶⁴ Watkins-Baker, Helga, *Kiln Forming Glass* (Ramsbury: The Crowood Press, 2010), p. 187

Only a thin skin on the surface of each piece of frit needs to melt and only enough for it to fuse with its neighbour. Since the glass does not flow, pâte de verre can be fused on a flat surface and then slumped, for example. It does not necessitate a mould – the fundamental requirement of the casting process – although moulds are almost always used.

This is undoubtedly why Cros himself referred to pâte de verre as a 'verre mou'⁴⁶⁵ (soft glass) rather than a 'coulée de verre' (flowing/running glass) technique.

⁴⁶⁵ Frantz, Susanne K, and Jean-Luc Olivié, *The Mythologies, Origins, and Developments of Pate de Verre in Particle Theories: International Pâte de Verre and Other Cast Glass Granulations* (Millville, N.J.: Museum of American Glass at Wheaton Village, 2005), Exhibition Catalogue, p. 10

APPENDIX IV CV

BORN:

Toronto, Canada, 1960

EDUCATION:

2018 PhD, Royal College of Art, London (Glass)

2010 MA, Shanghai University, Shanghai, China (Glass)

2001 BFA, Hong-ik University, Seoul, Korea (Metal)

1997 Foundation Year Diploma, Ontario College of Art and Design, Toronto

1986 LL.B/D. Juris, Osgoode Hall Law School, Toronto, Ontario

1983 BA (Hons.), Queens University, Kingston, Ontario (Russian)

PROFESSIONAL QUALIFICATIONS:

Barrister and Solicitor in and for the Province of Ontario

HONOURS:

Corning Museum of Glass Scholarship, 2013

Pilchuk Glass School, Professional Artist in Residence, 2010

Academy Award [*sic*] (Best in Show) for *New Shanghai* and *New Shanghai #2*
at the Third Chinese Academy Exhibition of Modern Arts and Crafts,
Shanghai, China, 15th -20th January, 2008

Award of Excellence for Miao Mix at the Second Chinese Academy Exhibition of
Modern Arts and Crafts, Nanjing Arts Institute, Nanjing, China 5th-20th
December, 2007

Special Work Award for Miao Mix Necklace at the China International Creative
Industries Exhibition, Shanghai New International Expo Centre,
November 1-5, 2006

Hong-ik University Scholarship, 2000

Korea Design Centre Award of Merit, 1999

Hong-ik University Scholarship, 1999

EXHIBITIONS:

Graduation Exhibition, Royal College of Art, June 2017

Work in Progress Exhibition, Royal College of Art, January 2017

Contemporary Glass Society Online Exhibition, 'Green Alchemy', September 2015 <<http://www.cgs.org.uk/exhibitions/green-alchemy> >

Work in Progress Exhibition, Royal College of Art, January 2016

Contemporary Glass Society Online Exhibition, 'Strike a Balance', January 2015 <<http://www.cgs.org.uk/exhibitions/strike-balance> >

Work in Progress Exhibition, Royal College of Art, January 2015

Contemporary Glass Society Online Exhibition, 'Strike a Balance', December 2014 <<http://www.cgs.org.uk/exhibitions/strike-balance>>

Contemporary Glass Society Online Exhibition, 'On Stormy Ground: Forces of Nature', April 2014 <<http://www.cgs.org.uk/exhibitions/stormy-ground-forces-nature> >

Glass Art Society 2013 International Student Online Exhibition, Selected Work, http://www.glassart.org/2013_International_Student_Online_Exhibition.html (June 2013)

Citizen Art Shanghai 2013, Renaissance Shanghai Yu Yuan Garden, Shanghai (April 3-May 31, 2013)

ArtShanghai 2013, New Glass Art Pavilion, New Town Central Park, Shanghai (April 18-22 2013)

New Glass Art Exhibition, Shanghai Moller Villa, Shanghai (March 22-27 2013)

Work in Progress Exhibition, Royal College of Art, January 2013

Foundation Winter Show, Two Cities Gallery, Shanghai (December 2012-February 2013)

Art Shanghai 2012 Exhibition, Hongqiao New Town Central Park, Shanghai China (May 2012)

Irish Wave 'Elements' Exhibition, Shengling Gallery, Shanghai (March 2012)

McKinsey & Co. Summer Art Exhibition, 1 Jermyn Street, London (June-August, 2011)

2010 Institution School Glass Art, 1933 Art Pavilion, 10 Shajing Road, Shanghai (June-October 2010)

MA Student Graduation Exhibition, Shanghai University College of Fine Art (June 7-19, 2010)

- Entering the Workshop - The Fifth Chinese Academy Exhibition of Modern Arts and Crafts, Shandong University of Art and Design, Jinan City, Shandong Province (December 24-27, 2009)
- Casting 2009: Studio Glass Art Exhibition, Fine Arts College of Shanghai University, 99 Creative Centre, Floor 1, Bldg. 6, No. 50 Moganshan Rd., Shanghai, China (March 2009)
- Fine Workmanship – the Fourth Chinese Academy Exhibition of Modern Arts and Crafts, Xian Arts Institute, Xian City, Shaanxi Province, China (January 2009)
- Mid-term Graduate Student Exhibition of the class of 2010, Shanghai University, Shanghai, China (Spring 2009)
- Transparent Attitude: Joint Exhibition of 3 Glass Studios, Fine Arts Museum, China Academy of Fine Arts, Hangzhou City, Zhejiang Province, China (December 2008)
- International Creative Industries Exhibition, Shanghai International Exhibition Centre, Shanghai, China (October 2008)
- True to Conventional Artistic Production – The Third Chinese Academy Exhibition of Modern Arts and Crafts, Shanghai, China (January 2008)
- Refraction: China's Contemporary Glass, TwoCities Gallery, 50 Moganshan Road, Shanghai China (October 2007-January 2008)
- Shanghai Cultural Development Foundation funded project: 2007 Glass Arts Exhibition, Shanghai University, Shanghai Art Museum, Shanghai, China (August-October, 2007)
- Shanghai Contemporary Arts and Crafts Exhibition, Shanghai Arts and Crafts Museum, Shanghai, China (January 2007)
- Tradition and Fashion - the Second Chinese Academy Exhibition of Modern Arts and Crafts, Nanjing Arts Institute, Nanjing City, Jiangsu Province, China (December 2006)
- 18th Sino-Japanese Art Exchange Show, Fine Art College of Osaka, Osaka, Japan (September 2006)
- Academy-Style Glass Art – Works of Zhuang Xiaowei and His Students, Hosted by americanartnetworking.com, Xuhui Library, Shanghai China (April-May, 2006)

New Wave Studio Glass Exhibition, Twocities Gallery, 50 Moganshan Road,
Shanghai, China (December 2005 to March, 2006)

Inheritance and Innovation – the First Chinese Academy Exhibition of Modern
Arts and Crafts, Fine Arts College of Tsinghua University, Beijing, China
(November 2005)

PUBLICATIONS:

Labatt, Sheila, 'Glass as Ink: Seeking Spontaneity from the Casting Process',
PhD Thesis, Royal College of Art, 2018

Corning Museum of Glass, New Glass Review 35, 2014

Bryan, Colleen, Hot Glass Studio Profile - Sheila Labatt, Glass Art Magazine,
January/February 2013 edition, Vol. 28, No. 1, pp.48-52

Chen, Yao Ming, Harmony and Difference: Professor-endorsed Art and Design
Student Portfolio, August 2012, Shanghai University Press, ISBN 978-
7567102545 (in Chinese)

ArtShanghai 2012 Catalogue, May 2012, p. 206,
<http://artshanghai.net/en/electronic.asp>

Lee Taub, Vanessa and Nina Hourdin, Shanghai Museum of Glass Opens,
Galerie Vee Newsletter, May
2011, <http://www.galerievee.com/news/detail/SHMOG/en/>

Hourdin, Nina, L'art verrier contemporain en Chine, Masters Thesis, Art History,
Université de Paris IV-Sorbonne, September 2010, pp. 95, 96, 101, 110;
Catalogue of Artists pp.174-181; Text Illustration numbers 39, 62 and 63,
page 32; Bibliography pp. 124 and 126 (in French)

Labatt, Sheila, 危险的艺术 (Danger in Art), Masters Thesis, Shanghai University,
2010 (in Chinese)

Labatt, Sheila, 反射中的建筑景观 (Reflected Architectural Landscapes), New
Vision Art, 2009.5, ISSN 1673-9914, pages 94-95 (in Chinese)

Labatt, Sheila, 建筑中的“危险”及其对我的作品的影响 (Impact of Dangerous
Architecture on my Work), Idea & Design, 2009 Volume 4, ISSN 1674-
5159, pages 60-63 (in Chinese)

Entering the Workshop (走进手工作坊), Collection of the works on The Fifth
Chinese Academy Exhibition of Modern Arts and Crafts, Shandong Fine
Art Publishing House 2009.12 ISBN 978-7-5330-3112-1 (in Chinese)

- Art of Design, Journal of Shandong University of Art and Design (设计艺术(山东工艺美术学院学报), 2009.06, ISSN 1674-2281 (in Chinese)
- Fine Workmanship (精工造物), 2009, Xian Academy of Fine Arts (in Chinese)
- Metropolitan Art – Public Art Centre, A Record of the Fine Arts Institute: 50 Year Retrospective of the Fine Arts College of Shanghai University (翰墨五十年——中国画系史料集), 2009.5, Shanghai Peoples Art Press, 2009.5, ISBN 978-7-5322-6238-0 (in Chinese)
- Nu Wa Treasures – Glass (女娲的遗珍——琉璃), edited by Wang Jin Chongqing Press, 2008.1 ISBN 978-7-5366-9272-5, Miao Mix II and Bird Flu, pp. 13, 179 (in Chinese)
- Shanghai Arts & Crafts (上海工艺美术), Introduction of Modern Artiquity [sic], 2008, No.1, ISSN 1005-071-X (in Chinese)
- Zhuang Xiaowei, Casting Light on the Lyrical - Research into the Methodology of Glass Art (铸造诗意——玻璃艺术创作方法论研究), Shanghai Book Store Publishing House, 2008 ISBN 978-7-80678-800-4 (in Chinese)
- Refraction: China's Contemporary Glass Art (新浪潮: 现代工作室玻璃艺术), 2007, Twocities Gallery
- Institution School Glass Art (学院派玻璃艺术), Shanghai Book Store Publishing House, 2007 ISBN 978-7-80678-748-9 (in Chinese)
- Shanghai Art & Crafts (上海工艺美术), 2007 No. 4, ISSN 1005-071-X (in Chinese)
- New Wave Studio Glass, 2005, Twocities Gallery
- Inheritance and Innovation (传承与超越), 2005, Liaoning Fine Arts Publishing House 2005/11, ISBN 7-5314-3727-9 (in Chinese)

APPENDIX V TESTS AND RESULTS

This Appendix reproduces relevant studio notes kept for tests conducted during the course of this research. It includes the objectives of each test, materials used, firing schedules, results and reflections and is illustrated by sketch book diagrams and photographic images.

TEST #1

Materials:

Glasma Furnace Glass
Kugler Opal Black (095)

Mould Type:

Plaster, silica, fibreglass

Firing Type:

Kiln casting

Firing Schedule:

20°/h to 200°, Soak 1 hour
200°/h to 600°
30°/h to 820°, Soak 1 hour
Full to 500°, Soak 4 hours
8°/h to 363°
25°/h to 50° OFF

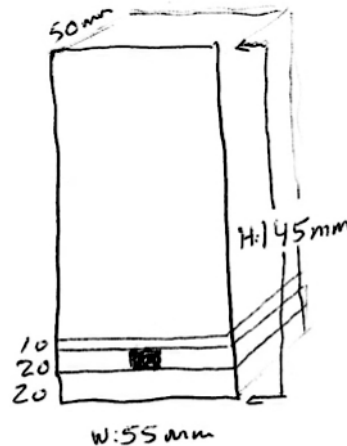

Hole: H: 20 \varnothing 19.5
Volume: 5,969.9mm³

Notes:

The purpose of the test was to evaluate the effect of bubble running on black powder inclusions.

A block of clear, hot cast glass was cut into four parts and a hole was drilled through one of the 'slices'. A thin layer of black powder was placed between each of the layers. The block was then reassembled with the 'hole' layer sandwiched inside the others. The hole was intended to become a bubble during the firing and to rise, dragging the colour with it. The result shows that the temperature of 820° was not high enough to create a flowing ink wash effect. 15x6x5cm. Photos: Sheila Labatt

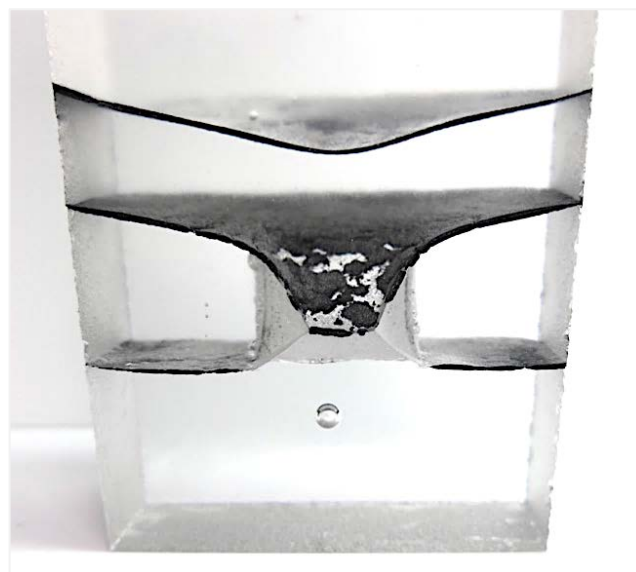

TEST #2

Materials:

Glasma Furnace Glass
Kugler Opal Black (095)

Mould Type:

Kiln shelves cut to size,
coated in batt wash and
supported with kiln bricks

Firing Type:

Kiln casting

Firing Schedule:

20°/h to 400°
Full to 820°, Soak 4 hours
Full to 500°, Soak 8 hours
4°/h to 320°
6°/h to 50° OFF

Notes:

The purpose of the test was to observe the effect of bubble running through a block with existing, ink-like, hot cast powder inclusions.

A hot glass block - composed of clear furnace glass and black opal powder – was cut into three even 'slices'. A hole was drilled through the middle slice and the block was reassembled and fired. The block was re-cut, post firing, to reveal the marks left inside the piece. The result reveals that the hole had turned into a bubble that had escaped the piece to leave a clean, high-contrast, saturated 'ink' effect. 15x13x10cm. Photos: Sheila Labatt

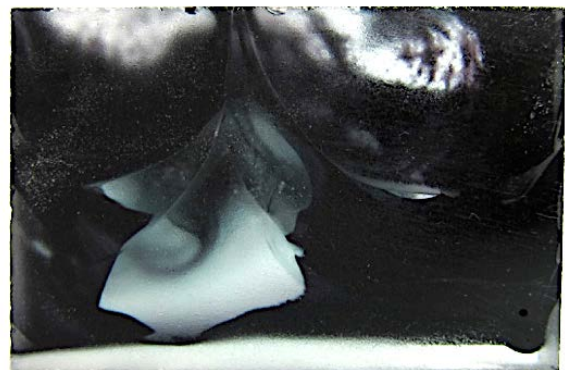

TEST #3

(Algonquin Blues II, 2012)

Materials:

Glasma Furnace Glass
Gaffer Black (G050)
Gaffer Opaline Grey (G192)

Mould Type:

Plaster, silica, fibreglass

Firing Type:

Hot casting

Firing Schedule:

Hot glass into mould at 500°
Full to 850°, Soak 4 hours
Full to 500, Soak 10 hours
6°/h to 320°
10°/h to 50° OFF

Notes:

The test was to observe whether glass powder rolled onto a gather in hot casting could produce an ink wash effect without further manipulation of the colour.

Black and grey powders were rolled, in varying densities on several gathers, and hot cast into a pre-heated mould inside a kiln. Post firing, the block was cut and polished to reveal the imagery inside the glass. The result shows 'ink wash' in gradations of saturation beginning with dark at the bottom and light at the top, as can be seen in brush and ink landscape paintings. The black powder turned blue where it was thinly applied in due to the oxides used to create Gaffer 'black'. 28x12x10cm. Photo: Sylvain Deleu



TEST #4

Materials:

Glasma Furnace Glass
Kugler, Opal Black (095),
Imperial Red (K125A)

Mould Type:

Steel mould on marver

Firing Type

Annealing

Firing Schedule:

Hot glass straight into Lehr
500°, Soak 12 hours
6°/h to 320°, Soak 6 hours
10°/h to 200°
25°/h to 50° OFF

Notes:

The purpose was to observe line and 'ink' qualities using cane pulled, from colour rods, as inclusions during hot casting.

Black and red cane were pulled and slumped at 520°, then sandwiched between several gathers of clear glass, while hot casting. The result shows that black Kugler Colour has a slightly metallic sheen to it. The Imperial Red remained vibrant and the cane produced a strong, saturated overall ink-like effect inside the piece. 21x18x12cm. Photos: Sheila Labatt



TEST #5

Materials:

Glasma Furnace Glass
Kugler Opal Black (095)
Kugler Imperial Red (K125A)

Mould Type:

Plaster, silica, fibreglass

Firing Type:

Kiln casting

Firing Schedule:

50°/h to 400°
100°/h to 870, Soak 4 hours
Full to 500°, Soak 8 hours
6°/h to 320°
10°/h to 350°
25°/h to 50° OFF

Notes:

The purpose was to evaluate the effect, on cane inclusions, of bubbles from holes placed horizontally inside the piece via vertical cuts.

A hot cast block, with black and red cane inclusions, was cut lengthwise and drilled crosswise between cuts, as shown. The block was reassembled and fired so that the drilled holes would turn into bubbles and flow, dragging the colour parallel to the direction of the vertical cuts. The result shows good movement in the colour inclusions and a strong, saturated, gestural, ink-like effect, evocative of calligraphy. The vertical cuts caused substantial veiling, which emphasizes the movement within the piece. 19x12x7cm. Photos: Sheila Labatt



TEST #6

Materials:

Bullseye Tekta
Glassline Black
Bullseye Black

Mould Type:

ThinFire paper

Firing Type:

Fusing

Firing Schedule:

204°/h to 538°
316°/h to 804°, Soak 10 min
Full to 516°, Soak 1 hour
60°/h to 388°
Full to 25° OFF

Notes:

The purpose of the test was to see whether gestural lines could be created by hand, using Glassline liquid colour (commercially available glass powder in suspension) and whether an ink wash effect could be created by spreading glass powder using an Oral B vibrating dispenser.

The Glassline liquid black colour was applied from a squeezable bottle tip and black Bullseye powder was applied by dragging the Oral B vibrating device, loaded with glass powder, across the surface of the glass. The colour was then fused into the supporting glass base. The result shows that neither the hand-drawn lines nor the powder 'washes' are spontaneous enough to evoke brush and ink painting or calligraphy. Presumably, practice in colour application would improve the result. 7x9x0.2cm. Photos: Sheila Labatt

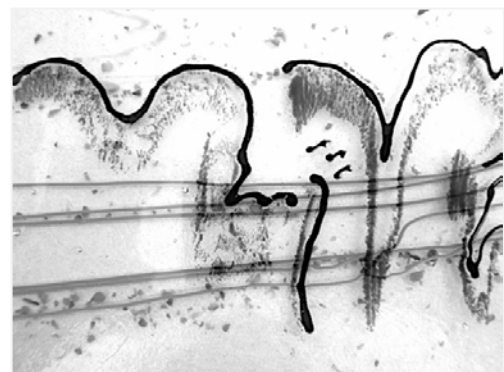

TEST #7

Materials:

Glasma Furnace Glass
Kugler Opal Black (095)
Acrylic Medium

Mould Type:

Plaster, silica, fibreglass

Firing Type:

Kiln casting

Firing Schedule:

50°/h to 400°
100°/h to 880°, Soak 4 hours
Full to 500°, Soak 12 hours
6°/h to 320°, Soak 6 hours
10°/h to 200°
25°/h to 50° OFF

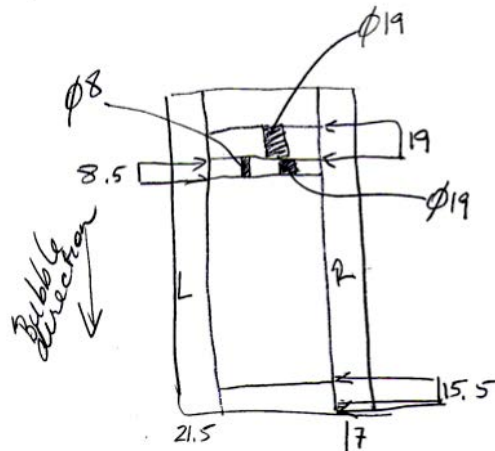

Notes:

The purpose of the test was to evaluate the effect of bubble running on colour placed between horizontal cuts in the block and framed by vertical cuts, to determine whether imagery could appear 'framed' within clear glass on either side.

A hot cast block was cut both vertically and horizontally and holes were drilled through the horizontal 'slices'. Black glass powder, suspended in acrylic medium, was painted on the surfaces of both the vertical and horizontal cuts. The result shows well-saturated black, ink-like fields of colour both horizontally and vertically within the piece, with more movement seen in the centre, where the holes had been drilled. 12x8x7cm. Photos: Sheila Labatt and Sylvain Deleu

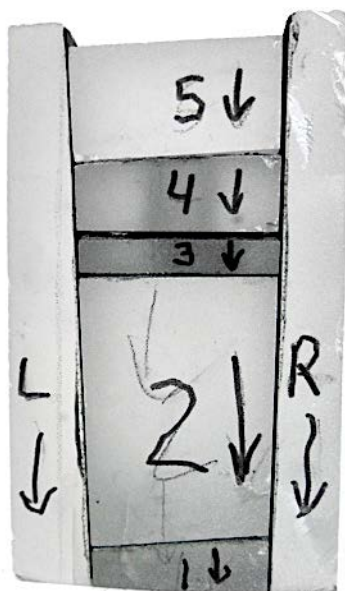

TEST #8

Materials:

Glasma Furnace Glass
 Ceramic Enamels:
 black, orange, white and grey
 Universal medium

Mould Type:

Plaster, silica

Firing Type:

Kiln casting

Firing Schedule:

50°/h to 400°
 100°/h to 880°, Soak 4 hours
 Full to 500°, Soak 12 hours
 6°/h to 320°, Soak 6 hours
 10°/h to 200°
 25°/h to 50° OFF

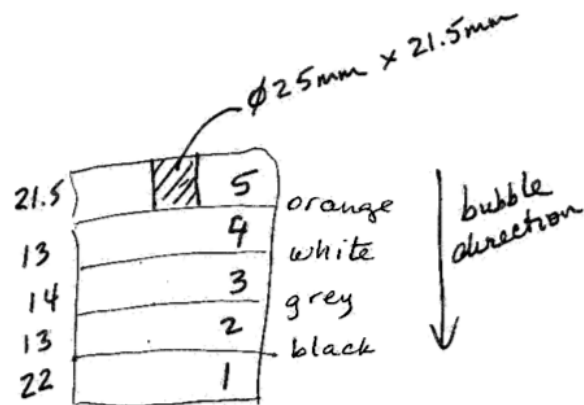

Notes:

The purpose of the test was to observe how ceramic enamel would behave when mixed with glass and whether a smooth transition from one colour to the next could be achieved through bubble running.

A clear hot cast block was cut into five 'slices' and one hole was drilled through what would be the outermost slice, as shown. Four surfaces of the slices were painted, each with a different colour, using ceramic enamel suspended in medium. The block was then reassembled, with the colours placed from darkest to lightest in the sequence, as shown in the diagram. The result shows that the hole became a bubble during firing, dragging and mixing the colours, showing vague gradation. Many smaller bubbles were also created, perhaps because of the ceramic enamel's interaction with the glass. 8x6x6cm. Photos: Sheila Labatt



TEST #9

(Wedding Duck, 2012)

Materials:

Glasma Furnace Glass
 Glass Enamel, Black
 Universal Medium

Mould Type:

Plaster, silica, fibreglass

Firing Type:

Kiln casting

Firing Schedule:

100°/h to 880°, Soak 5 hours
 Full to 500°, Soak 12 hours
 6°/h to 320°, Soak 6 hours
 10°/h to 200°
 25°/h to 50° OFF

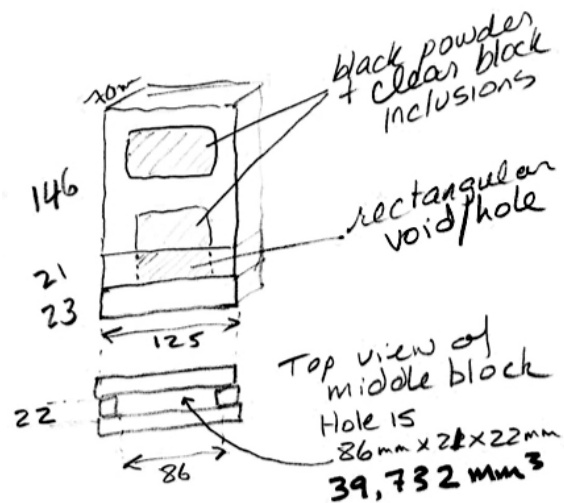

Notes:

The purpose of the test was to evaluate how colour moves under the effect of a large bubble within the piece.

A hot cast block with black powder inclusions was cut into three 'slices' and black powder suspended in universal medium was painted between on the surface of each slice. The block was re-assembled, so that a rectangular void would be place in the centre section of the block, and fired. The result shows that the large, rectangular void yielded large bubble, which, surprisingly didn't fire out at 880° and which moved slightly upwards and sideways, dragging the colour with it. The black powder turned blue in areas of thin 'wash' but gave an overall ink-like effect. 19x13x7cm. Photos: Sheila Labatt and Ester Segarra



TEST #10

Materials:

Glasma Furnace Glass
Ceramic Enamel, Black
Acrylic Medium

Mould Type:

Plaster, silica, fibreglass

Firing Type:

Kiln casting

Firing Schedule:

20°/h to 100°
50°/h to 530°
100°/h to 900°, Soak 2 hours
Full to 500°, Soak 12 hours
6°/h to 320°, Soak 6 hours
10°/h to 200°
25°/h to 50° OFF

Notes:

The purpose of the test was to evaluate how bubble running would affect organic lines, carved into a block and filled with colour.

A hot cast block was cut into three 'slices'. Curved lines were then carved out of two slices using a 19mm drill bit, approximately 1mm deep, and filled with black ceramic enamel powder suspended in acrylic medium. A hole was drilled through the third slice, using a 19mm drill bit. The block was reassembled, with the 'hole' slice in the centre of the block, and fired. The result shows that the hole and small gaps in the powder, inside the curved lines, became bubbles and dragged the colour upwards to produce delicate, organic, blue lines, with only small bubbles remaining trapped inside the piece. 11x7x7cm. Photos: Sheila Labatt and Sylvain Deleu

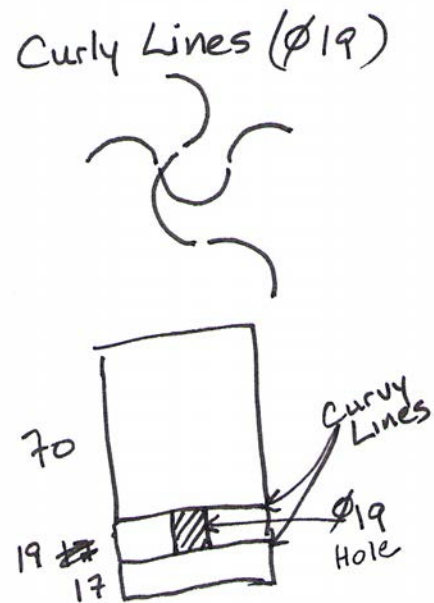

TEST #11

Materials:

Glasma Furnace Glass
 Gaffer Black (G050)
 Universal Medium

Mould Type:

Plaster, silica, fibreglass,
 Crystalcast

Firing Type:

Kiln casting

Firing Schedule:

20°/h to 100°
 50°/h to 530°
 100°/h to 900°, Soak 2 hours
 Full to 500°, Soak 12 hours
 6°/h to 320°, Soak 6 hours
 10°/h to 200°
 25°/h to 50 OFF

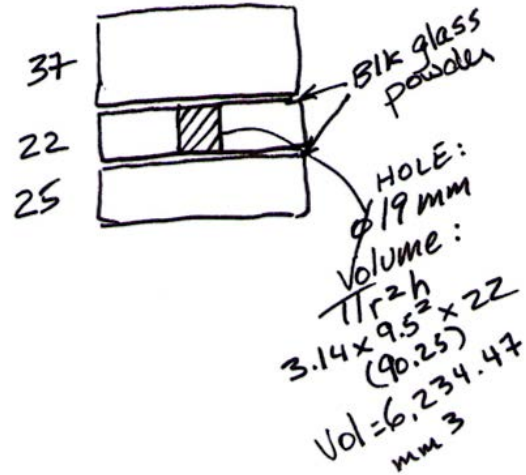

Notes:

The purpose of the test was to evaluate the effect of bubble running through fields of black glass powder.

A hot cast block was cut into three 'slices' and a single hole was drilled through the centre slice. Black glass powder, suspended in universal medium, was applied to the surface of the other two slices. The whole block was then reassembled, with the 'hole' slice placed in the centre of the block, and fired. The result shows that the hole turned into a bubble inside the molten glass, dragged the colour upwards and fired out. The black glass powder yielded a pointilistic effect. 8x7x7cm. Photos: Sheila Labatt



TEST #12

Materials:

Glasma Furnace Glass
 Ceramic Enamel, Black
 Universal Medium

Mould Type:

Plaster, silica, fibreglass

Firing Type:

Kiln casting

Firing Schedule:

20°/h to 100°
 50°/h to 530°
 100°/h to 900°, Soak 2 hours
 Full to 500°, Soak 12 hours
 6°/h to 320°, Soak 6 hours
 10°/h to 200°
 25°/h to 50° OFF

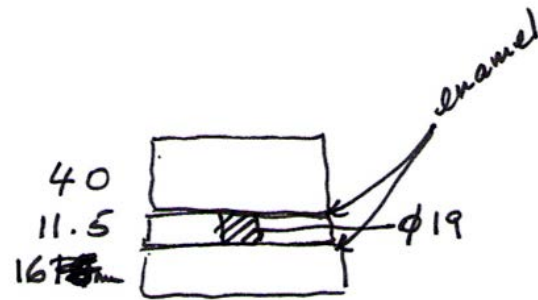

Hole Volume
 $\pi \times 9.5^2 \times 11.5$
 3,258.92 mm³

Notes:

The purpose of the test was to see whether ceramic enamel powder yielded more saturated colour than glass powder, in creating 'ink washes'.

A hot cast block was cut into three sections and a single hole was drilled through the centre 'slice'. Ceramic enamel powder suspended in universal medium was applied by brush to the surface of the other two slices. The whole block was reassembled, with the 'hole' slice in the middle, and fired. The result shows that the hole turned into a bubble, dragging the colour upwards, and fired out of the piece. The ceramic enamel powder remained dark but slightly blue and produced a smooth, ink-like effect. 8x7x7cm. Photos: Sheila Labatt and Sylvain Deleu



TEST #13

(Bonzai, 2013)

Materials:

Glasma Furnace Glass
 Ceramic Enamel, Black
 Acrylic Medium

Mould Type:

Plaster, silica

Firing Type:

Kiln casting

Firing Schedule:

20°/h to 100°
 50°/h to 530°
 100°/h to 900°, Soak 2 hours
 Full to 500°, Soak 12 hours
 6°/h to 320°, Soak 6 hours
 10°/h to 200°
 25°/h to 50° OFF

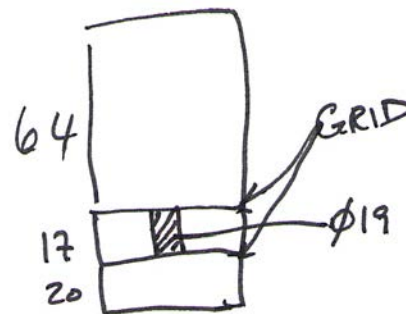

Hole Vol:
 $\pi \times 9.5^2 \times 17$
 $= 4,817.54 \text{ mm}^3$

Notes:

The purpose of the test was to see whether a shallow grid filled with black ceramic enamel would provide enough colour to evoke ink throughout the piece.

A hot cast block was cut into three sections on a diamond saw and one hole was cut through centre section. Ceramic enamel suspended in acrylic medium painted into the depressions of a shallow, sand blasted grid. The block was then reassembled and fired so that the hole, and small gaps in the ceramic enamel, would become bubbles in the molten glass and drag the colour in the grid upward. The result shows that the large bubble fired out of the piece and the shallow grid yielded delicate gestural lines, evocative of bonsai tree. The black enamel turned blue due to its light application and the oxides used to create 'black' enamel. 10x7x7cm. Photos: Sheila Labatt and Sylvain Deleu

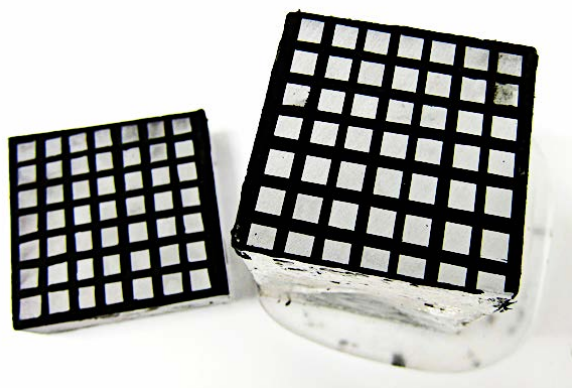

TEST #14

Materials:

Glasma Furnace Glass
 Ceramic Enamel, Black
 Acrylic Medium

Mould Type:

Plaster, silica, fibreglass,
 Crystalcast

Firing Type:

Kiln casting

Firing Schedule:

20°/h to 100°
 50°/h to 530°
 100°/h to 900°, Soak 2 hours
 Full to 500°, Soak 12 hours
 6°/h to 320, Soak 6 hours
 10°/h to 200°
 25°/h to 50° OFF

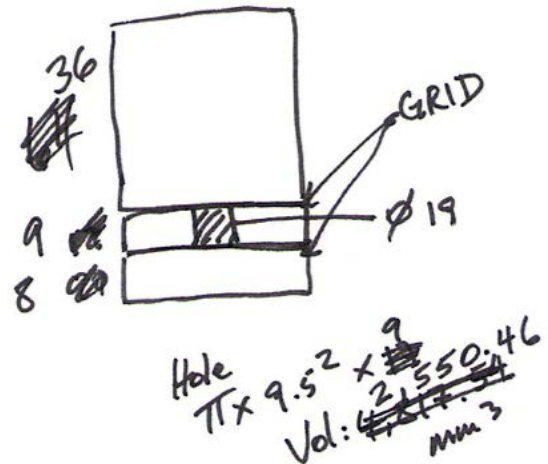

Notes:

The purpose of the test was to observe whether ceramic enamel yields saturated ink-like imagery and how a grid of black colour might respond to 'bubble running'.

A hot cast block was cut into three 'slices' and a single hole was drilled through the centre slice. A grid was then cut into two slices (width of 2.5mm and depth of 1.5mm) using a 30° angle wheel on a lathe. Ceramic enamel suspended in acrylic medium was painted into the grid lines and the block was reassembled and fired. The result shows strong, saturated, gestural lines which read as an organized pattern. 53x71x73. Photos: Sheila Labatt and Sylvain Deleu

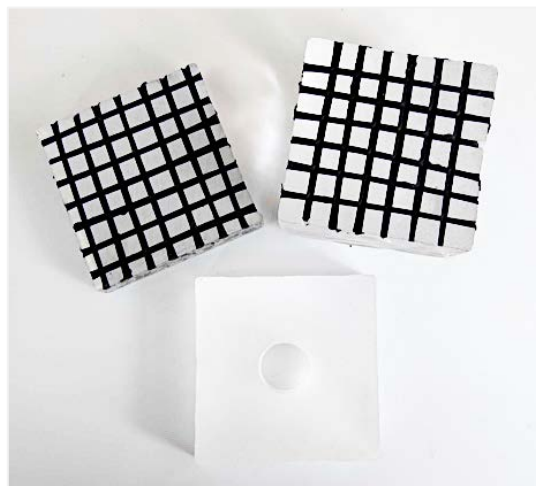

TEST #15

(Cloud Motif, 2012)

Materials:

Glasma Furnace Glass
Ceramic Enamel, Black
Acrylic Medium

Mould Type:

Steel mould on marver

Firing Type:

Annealing

Firing Schedule:

Full to 500°, Hot glass into lehr
Soak 12 hours
6°/h to 320°, Soak 6 hours
10°/h to 200°
25°/h to 50° OFF

Notes:

The purpose was to observe whether the painted motif on an inclusion would remain visible once hot cast.

Northeast Asian cloud motifs were painted onto clear eggshells, using ceramic enamel suspended in acrylic medium, and fused. The eggshells were then placed between three gathers, during hot casting, and gently manipulated – once softened - using long tweezers to distort them and render them three-dimensional inside the block of glass. The result shows that the cloud motif disappeared and, instead, left strong, gestural and apparently spontaneous ink-like marks. 28x12x11cm. Photos: Sheila Labatt



TEST #16

Materials:

Glasma Furnace Glass
Gaffer Colours (various)

Mould Type:

Steel mould on marver

Firing Type:

Annealing

Firing Schedule:

Full to 500°, Hot glass into lehr
Soak 12 hours
6°/h to 320°, Soak 6 hours
10°/h to 200°
25°/h to 50° OFF

Notes:

The purpose was to observe whether transparent, coloured eggshells could be used as inclusions to evoke ink washes.

Fused, coloured eggshells were placed between gathers during hot casting. The eggshells were gently manipulated, with long tweezers, once they had softened in the hot glass, to distort them and render three-dimensional wash marks. The result shows that the embedded, organic imagery remained mostly two dimensional but did evoke 'inky' fields of overlapping colour. 30x14x9cm. Photos: Sheila Labatt



TEST #17

(*Krakatoa*, 2013)

Materials:

Lead Crystal
Kugler, Opal Black (095)
Acrylic Impasto Medium

Mould Type:

Plaster, silica
Mild steel casing

Firing Type:

Kiln casting

Firing Schedule:

20°/h to 380, Soak 6 hours
10°/h to 830°, Soak 2 hours
Full to 650°
5°/h to 405°, Soak 60 hours
3°/h to 380°
5°/h to 300°
10°/h to 250°
25°/h to 50° OFF

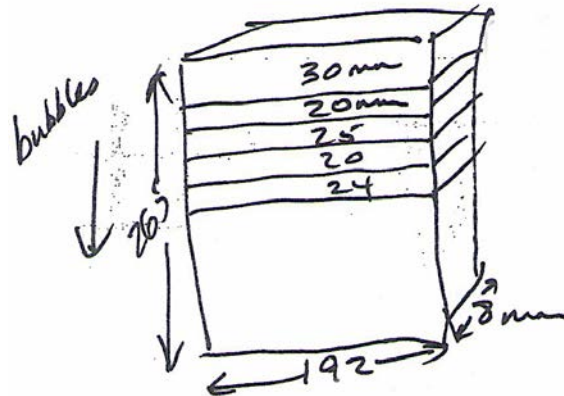

Notes:

The purpose was to create a piece with black powder inclusions, manipulated with bubbles, to produce an ink wash effect and evoke brush and ink landscape painting.

A pre-cast block was cut into 'slices'. Each slice was then carved with a grid (4mm deep) on the diamond saw and the carved grooves were half filled with black powder suspended in impasto medium. The rest of each surface was also heavily coated in the powder mixture. The result shows strong, saturated and well-defined ink 'line' and 'wash' effects. The spaces inside the grid, left behind when the medium melted out, created bubbles of air which flowed upward, dragging the colour with it. 27x19x8cm. Photos: Sheila Labatt and Xiao Jin

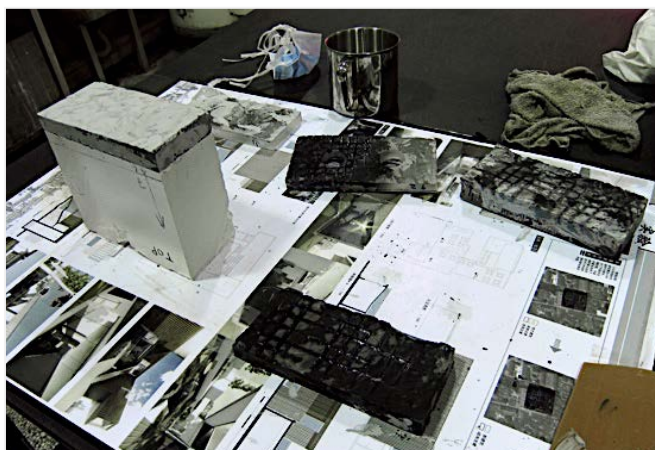

TEST #18

Materials:

Glasma Furnace Glass
Ceramic Enamel, Black
Ceramic Enamel, Red
Universal Medium

Mould Type:

Steel mould on marver

Firing Type:

Annealing

Firing Schedule:

500° object into Lehr, Soak 12 hours
6°/h to 320°, Soak 6 hours
10°/h to 200°
25°/h to 50° OFF

Notes:

The purpose was to observe whether drizzles of furnace glass coated in black and red ceramic enamel powder, suspended in water, would produce saturated 'ink' lines in the same way that glass cane does.

Drizzles of found furnace glass were heavily coated with ceramic enamel colour, suspended in water, and applied with a brush. The coated drizzles were then added into a mould as inclusions sandwiched between gathers during hot casting. The block was removed early, prior to fully solidifying, from the mould and allowed to slump before placing it in Lehr to anneal. The result is that the inclusions are not, in fact, very gestural but appear so due to the optics of the slumped surface. The colour of the ceramic enamel remained highly saturated and ink-like in the finished piece. 25x16x14cm. Photos: Sheila Labatt

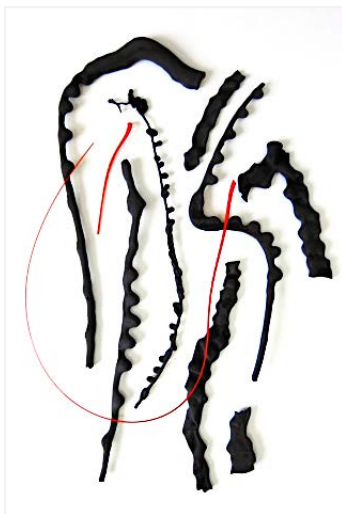

TEST #19

Materials:

Glasma Furnace Glass
Glassline Liquid

Mould Type:

Steel mould on marver

Firing Type

Annealing

Firing Schedule:

Hot glass straight into Lehr
500°, Soak 12 hours
6°/h to 320°, Soak 6 hours
10°/h to 200°
25°/h to 50° OFF

Notes:

The purpose of the test was to observe whether stringers coated in black Glassline (a commercial product in which glass powder is suspended in a liquid medium, in a squeeze bottle) could produce ink-like results in the same way that cane inclusions do.

The Glassline liquid was applied by brush to stringers of clear Glasma glass and then sandwiched and manipulated between clear glass gathers in a mould on a marver. The effect was that the Glassline colour caused the inclusions to bubble and appear slightly inky. The manipulated stringers produced spontaneous-looking, lines. Photo: Sheila Labatt

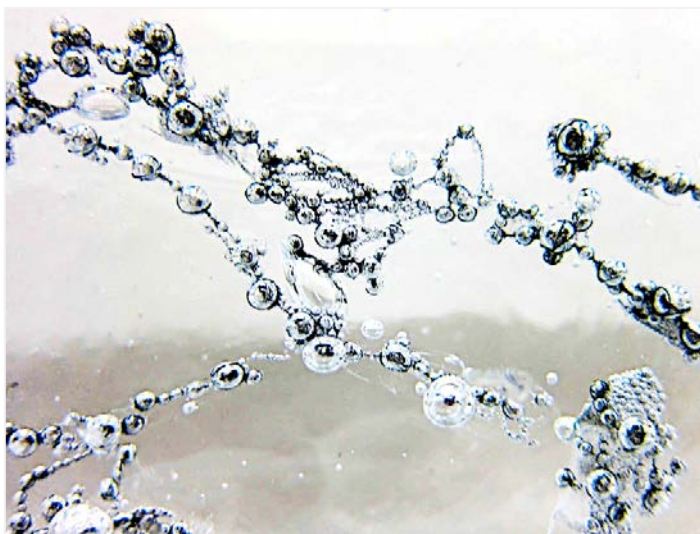

TEST #20

Materials:

Glasma Furnace Glass
Kugler, Opal Black (095)

Mould Type:

Steel mould on marver

Firing Type:

Annealing

Firing Schedule:

Hot glass directly into lehr
500°, Soak 12 hours
6°/h to 320°, Soak 6 hours
10°/h to 200°
25°/h to 50° OFF

Notes:

The purpose was to observe the effect and movements of black, translucent cane inclusions, manipulated when hot, inside a hot cast block.

Cane was pulled from clear glass with a gather rolled in black powder, as distinct from cane pulled from black rods, which provides more saturated colour. The cane then used as inclusions inside a hot cast block. The result shows streaky, 'flying white' stroke-like results. 25x18x13cm. Photos: Sheila Labatt



TEST #21

Materials:

Glasma Furnace Glass
Kugler, Opal Black (095)

Mould Type:

Plaster, silica, fibreglass

Firing Type:

Hot casting

Firing Schedule:

Full to 520°, add hot glass
Full to 850°, Soak 1.5 hours
Full to 500°, Soak 12 hours
6°/h to 320°
25°/h to 50° OFF

Notes:

The purpose of the test was to determine to what extent powder inclusions in hot cast glass could evoke ink washes.

Clear gathers were rolled in black powder on the marver and then hot cast into four pre-heated refractory moulds. The blocks were then sliced in half, post-firing, to reveal brush and ink-like imagery inside the blocks. The pieces range in size from 14x13x5cm to 24x14x10cm. Photos: Sheila Labatt



TEST #22

(*Flying White*, 2013)

Materials:

Glasma Furnace Glass
Kugler, Black Opal (095),
Imperial Red (K125A)

Mould Type:

Kiln shelves and firebrick

Firing Type:

Kiln casting

Firing Schedule:

40°/h to 400°
Full to 850°, Soak 4 hours
Full to 500°, Soak 8 hours
6°/h to 320°
10°/h to 50° OFF

Notes:

The purpose was to manipulate cane inclusions to evoke Grass Script calligraphy.

A hot cast block, with black and red cane inclusions, was cut and holes were drilled through the 'slices'. The piece was then reassembled, as shown, and fired. The drilled holes became bubbles, inside the molten glass, and dragged the coloured inclusions to result in the appearance of spontaneous and gestural brush and ink lines. 19x13x6cm. Photos: Sheila Labatt

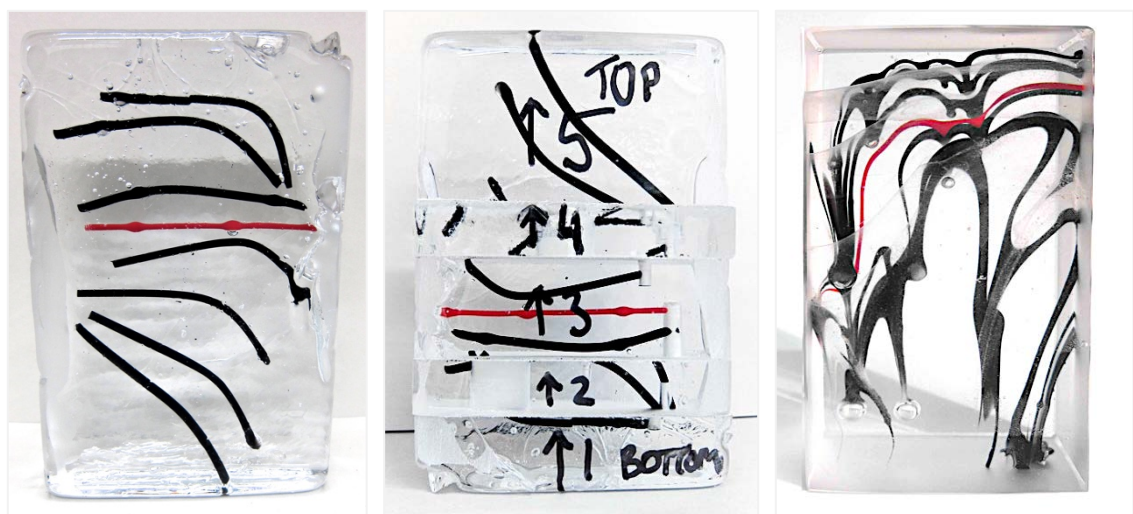

TEST #23

(Flying White [part II], 2013)

Materials:

Glasma Furnace Glass
Gaffer Black (G050),
Vermillion (G176)

Mould Type:

Plaster, silica

Firing Type:

Kiln casting

Firing Schedule:

20°/h to 380°, Soak 4 hours
50°/h to 500°
Full to 860°, Soak 4 hours
Full to 500°, Soak 20 hours
6°/h to 320°, Soak 6 hours
10°/h to 200°
25°/h to 50° OFF

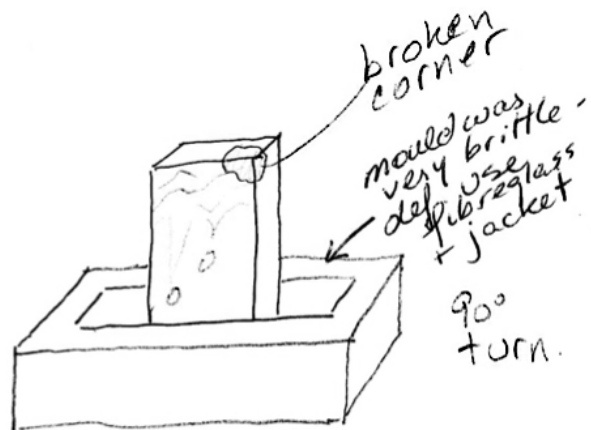

Notes:

The purpose was to investigate whether an otherwise well-composed piece comes out (differently but) equally successfully when re-fired in a different orientation.

This piece was re-cast for the test because it had a broken corner which could not be removed without negatively affecting the composition of the piece, which had many good, gestural brush and ink-like marks and well-situated bubbles. The result was that the piece came out with uninteresting solid black marks, all concentrated in the centre of the block. None of the refinement of the original piece came through. 13x10x7cm. Photos: Sheila Labatt



TEST #24

Materials:

Glasma Furnace Glass
Gaffer Colours (various)

Mould Type:

Centrifugal casting bowl

Firing Type:

Annealing

Firing Schedule:

Object into kiln at 500°, Soak 12 hours
6°/h to 320°, Soak 6 hours
10°/h to 200°
15°/h to 50° OFF

Notes:

The purpose of the test was to see whether gestural marks in clear glass can be achieved through the addition of colour during centrifugal casting.

Too much colour was used and the clear glass disappeared throughout most of the piece. Line quality and texture are nevertheless spontaneous looking on the rim in certain parts of the piece. Ø20x10cm. Photos: Sheila Labatt



TEST #25

Materials:

Glasma Furnace Glass
Kugler, Opal Black (095)
India Ink

Mould Type:

Plaster, silica

Firing Type:

Kiln casting

Firing Schedule:

40°/h to 380°, Soak 4 hours
50°/h to 500°
Full to 900, Soak 4 hours
Full to 500°, Soak 24 hours
6°/h to 320°, Soak 6 hours
10°/h to 200°
25°/h to 50° OFF

Notes:

The purpose was to test whether lines fused into billets and cast through a flowerpot hole would swirl or otherwise produce spontaneous lines in a hemispherical mould.

The kiln temperature was too hot and the lines disappeared into a black and green swirl. India ink was applied to the outside texture and wiped off the high parts, leaving random, ink fields on the surface of the piece, not inside the glass, that can be viewed through the polished, flat surface of the glass. Ø14x7cm.
Photos: Sheila Labatt



TEST #26

Materials:

Gaffer Furnace Glass
Gaffer Black (G050),
Vermillion (G176)

Mould Type:

Plaster, silica

Firing Type:

Hot casting

Firing Schedule:

Gathers into mould at 600°
Full to 850, Soak 2 hours
Full to 500°, Soak 25 hours
6°/h to 320°, Soak 6 hours
10°/h to 200°
25°/h to 50° OFF

Notes:

Flameworked cane inclusions were added between gathers which were poured into a pre-heated refractory mould. The casting created many bubbles and the piece cracked. Some good lines were left, however, and what was left of the bubbles created concave lenses that enhance the movement of the lines inside the glass. Each half is approximately 15x10x10cm. Photos: Sheila Labatt

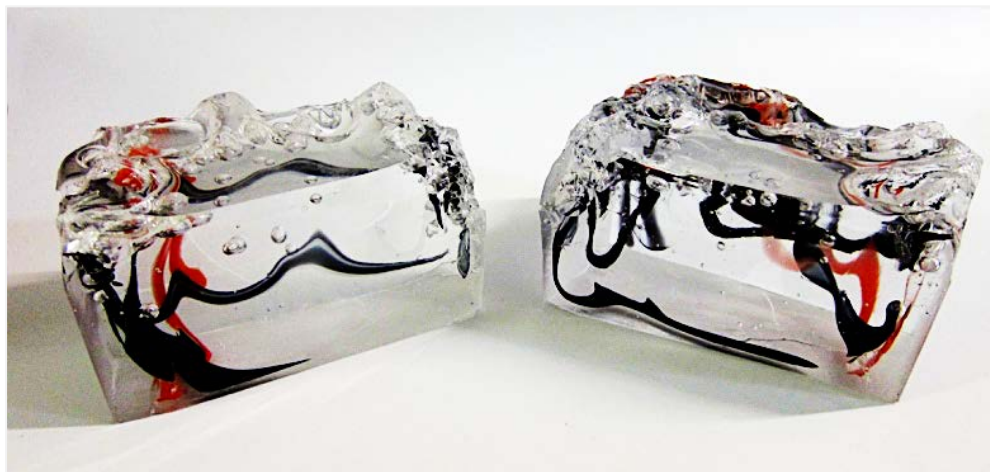

TEST #27

Materials:

Glasma Furnace Glass
Gaffer Black (G050),
Steel Blue (G253)

Mould Type:

Plaster, silica

Firing Type:

Hot casting

Firing Schedule:

Gathers into mould at 600°
Full to 500°
Firing aborted due to kiln malfunction

Notes:

The purpose of the test was to see whether the addition of a second powder colour (steel blue), in addition to black powder, would yield a greater appearance of depth in 'ink wash'.

Many bubbles resulted from these gathers and did not fire out of the piece because the firing did not proceed to full temperature. The bubbles created interesting convex lenses, through which one can look into the piece. The powders, picked up in the gathers, yielded a good number of lines as well as 'washes' and do seem to add a sense of special depth. Ø15x9cm. Photos: Sheila Labatt



TEST #28

(*Fan* [part I], 2013)

Materials:

Glasma Furnace Glass
Gaffer Black (G050),
Vermillion (G176)

Mould Type:

Plaster, silica, fibreglass

Firing Type:

Hot casting

Firing Schedule:

Gathers into mould at 600°
Full to 900°, Soak 2 hours
Full to 500°, Soak 20 hours
6°/h to 320°, Soak 6 hours
10°/h to 200°, Soak 5 hours
25°/h to 50° OFF

Notes:

Flameworked cane inclusions were introduced into a conical mould, between gathers, and were manipulated with long tweezers. The heat was then brought up to casting temperature to release any trapped bubbles. The result shows strong, calligraphic ink-like lines. Ø15x20cm. Photos: Sheila Labatt

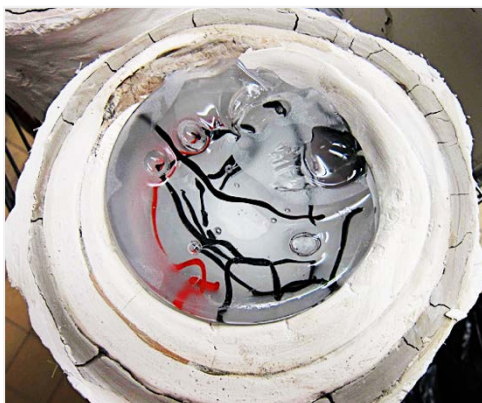

TEST #29

Materials:

Glama Furnace Glass
Gaffer Black (G050),
Light Tobacco (G104),
Vermillion (G176),
Ivory (G102)

Mould Type:

Plaster, silica

Firing Type:

Hot Casting

Firing Schedule:

Gathers into mould at 600°
Full to 900°, Soak 2 hours
Full to 500°, Soak 20 hours
6°/h to 320°, Soak 6 hours
10°/h to 200°, Soak 5 hours
25°/h to 50° OFF

Notes:

The purpose of the test was to see whether gestural, ink-like lines and washes could be produced by simultaneous application of powders and stringers.

Multiple colours of frameworked stringers and powders were picked up on hot gathers and deposited into a pre-heated cylindrical mould. The heat was then brought up to casting temperature in order to release any bubbles trapped within the piece. The result indicates that powders and stringers work can well together. Ø9x15cm. Photos: Sheila Labatt



TEST #30

(*Xiao Shan Shui* 小山水, 2014)

Materials:

Glama Furnace Glass
Gaffer Black (G050)
Gaffer Light Tobacco (G104)
Gaffer Vermillion (G176)
Ivory (G102)

Mould Type:

Plaster, silica

Firing Type:

Hot casting

Firing Schedule:

Gathers into mould at 600°
Full to 900°, Soak 2 hours
Full to 500°, Soak 20 hours
6°/h to 320°, Soak 6 hours
10°/h to 200°, Soak 5 hours
25°/h to 50° OFF

Notes:

The purpose was to produce 'ink wash' marks in some of the muted colours used in traditional Chinese landscape paintings.

Multiple colours of powders were picked up on gathers and deposited into a cylindrical mould. The heat was then brought up to casting temperature in order to release any bubbles trapped within the piece. Because the cast was so dark, the cylinder was then cut to reveal the imagery inside the piece. The result evokes ink wash. 11x8x2cm. Photos: Sheila Labatt and Sylvain Deleu



TEST #31

(*Fan II* [part I], 2013)

Materials:

Glama Furnace Glass
Gaffer Black (G050),
Light Tobacco (G104),
Ivory (G102)

Mould Type:

Plaster, silica, Crystalcast

Firing Type:

Hot casting

Firing Schedule:

Gathers into mould at 600°
Full to 900°, Soak 2 hours
Full to 500°, Soak 20 hours
6°/h to 320°, Soak 6 hours
10°/h to 200°, Soak 5 hours
25°/h to 50° OFF

Notes:

The purpose was to create 'ink wash' marks.

Multiple colours of powders were picked up on gathers and deposited into a pre-heated conical mould. Flameworked cane inclusions were also added, between gathers, and manipulated with long tweezers. The heat was then brought up to casting temperature to release any bubbles trapped within the piece. The cone was cut to better see the inclusions, which were 'inky' and showed both wash and line characteristics. Ø15x20cm. Photos: Sheila Labatt



TEST #32

(*Grass Script II*, 2015)

Materials:

Glasma Furnace Glass
Gaffer Black (G050)

Mould Type:

Plaster, silica

Firing Type:

Annealing

Firing Schedule:

Glass into mould at 600°
Full to 500°, Soak 20 hours
6°/h to 320°, Soak 6 hours
10°/h to 200°
25°/h to 50° OFF

Notes:

The purpose was to generate Grass Script-like lines.

Flameworked cane inclusions were placed into a conical mould between the final three (hot casting) gathers and were manipulated with long tweezers. The result yielded strong, calligraphic, ink-like lines. See Results section of thesis. Ø15x20cm. Photos: Sheila Labatt



TEST #33

Materials:

Glasma Furnace Glass
Gaffer Black (G050),
Light Tobacco (G104),
Sargasso Green (G034)

Mould Type:

Crystalcast

Firing Type:

Hot casting

Firing Schedule:

Glass introduced at 600°
Full to 850°, Soak 1 hour
Full to 500°, Soak 12 hours
6°/h to 320°, Soak 6 hours
10°/h to 200
25°/h to 50° OFF

Notes:

The purpose of the test was to investigate whether colour gradation would result in an ink 'wash' effect.

Powders were picked up on gathers (a different colour for each gather) and hot cast into a pre-heated mould, in order of darkest powders to lightest. The heat was then then brought up to casting temperature of 850° to release any bubbles within the piece. The result did not show a smooth gradation throughout the piece, which turned out very dark and difficult to read. Bubbles did not completely fire out at 850°. 8x8x8cm. Photo: Sheila Labatt



TEST #34

(*Parallax*, 2013)

Materials:

Glasma Furnace Glass
Gaffer Black (G050),
Vermillion (G176)

Mould Type:

Plaster, silica, Crystalcast

Firing Type:

Hot casting

Firing Schedule:

Glass introduced at 600°
Full to 720°, Soak 1 hour
Full to 500°, Soak 12 hours
6°/h to 320°, Soak 6 hours
10°/h to 200°
25°/h to 50° OFF

Notes:

The purpose was to generate Grass script-like calligraphic lines.

Flameworked cane inclusions were added into a pre-heated hemispherical mould and, between clear gathers, were manipulated with long tweezers. The result shows that bubbles were generated during the hot casting process and did not completely fire out at a top temperature of 720°. When the surface of the piece was ground, the bubbles broke apart leaving behind concave lenses. They distort the already gestural, ink-like lines inside the piece and create a parallax effect in which the same inclusion can be viewed simultaneously from apparently different angles. Ø15x8cm. Photos: Sheila Labatt



TEST #35

(*Fan* [part II], 2014)

Materials:

Glasma Furnace Glass
Gaffer Black (G050),
Vermillion (G176)

Mould Type:

Plaster, silica, fibreglass

Firing Type:

Kiln casting

Firing Schedule:

70°/h to 500°, Soak 1 hour
Full to 860°, Soak 4 hours
Full to 500°, Soak 16 hours
6°/h to 320°, Soak 6 hours
10°/h to 200°
25°/h to 50° OFF

Notes:

The purpose was to evoke Grass script calligraphy, painted on a fan.

A previously cast cone with black and red frameworked inclusions was cut into truncated triangles and re-fired in a fan-shaped mould. The result shows good, gestural brush and ink-like lines. 30x19x5cm. Photos: Sheila Labatt and Sylvain Deleu

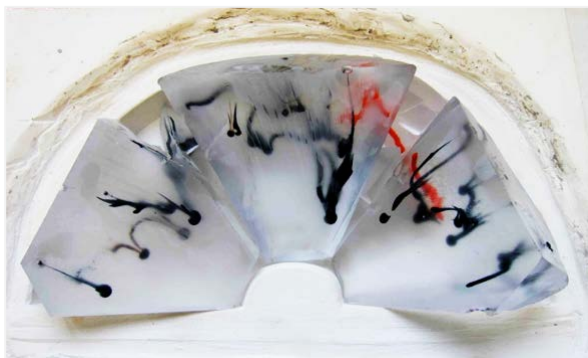

TEST #36

(*Fan II* [part II], 2014)

Materials:

Glasma Furnace Glass
Gaffer Black (G050),
Light Tobacco (G104),
Ivory (G102)

Mould Type:

Plaster, silica, fibreglass

Firing Type:

Kiln casting

Firing Schedule:

70°/h to 500°, Soak 1 hour
Full to 860°, Soak 4 hours
Full to 500°, Soak 16 hours
6°/h to 320°, Soak 6 hours
10°/h to 200°
25°/h to 50° OFF

Notes:

The purpose was to evoke ink wash painting on fans.

A previously cast cone with powders and frameworked inclusions was cut into truncated triangles and re-fired in a fan-shaped mould. The result shows a strong ink wash effect. See Results section of thesis. 30x19x5cm. Photos: Sheila Labatt and Sylvain Deleu



TEST #37

Materials:

Bullseye Tekta,
Black Opal (0100),
White Opal (0113),
Tomato Red (0024)

Mould Type:

ThinFire paper

Firing Type:

Fusing

Firing Schedule:

300°/h to 820°, Soak 10 min
Full to 515°
Soak 10 min OFF

Notes:

The purpose was to create fused elements for later use in kiln casting.

Uneven lines were created by placing small pieces of Tekta between and on top of straight stringers, all of which sit atop two 60x60x3mm Tekta slides, which were used as a base for the whole element. The result shows saturated, organic, ink-like lines. 60x60x6mm. Photos: Sheila Labatt



TEST #38

Materials:

Bullseye Tekta,
Black Opal (0100),
White Opal (0113),
Tomato Red (0024)

Mould Type:

ThinFire paper

Firing Type:

Fusing

Firing Schedule:

300°/h to 820°, Soak 10 min
Full to 515°
Soak 10 min OFF

Notes:

The purpose was to prepare 'fan' design elements for casting.

One and two-millimetre stringers were placed and fused onto a 6mm clear Tekta slide. The result showed a strong, saturated, fan shaped design with no apparent movement of the stringers during firing. 60x60x6mm. Photos: Sheila Labatt

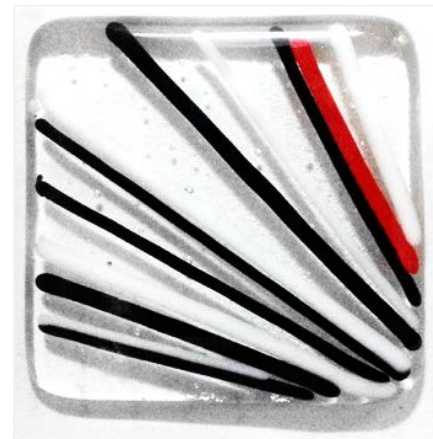

TEST #39

Materials:

Bullseye Tekta,
Black Opal (0100)

Mould Type:

ThinFire paper

Firing Type:

Fusing

Firing Schedule:

300°/h to 820°, Soak 10 min
Full to 515°
Soak 10 min OFF

Notes:

The purpose was to fuse elements with a grid design in preparation for kiln casting.

A grid was prepared using 2mm stringers on 6mm of clear Tekta. The result was a saturated, fairly tight and accurate grid. 60x60x6mm. Photos: Sheila Labatt



TEST #40

Materials:

Bullseye Tekta,
Black Opal (0100),
White Opal (0113),
Tomato Red (0024)

Mould Type:

Ceraboard

Firing Type:

Kiln casting

Firing Schedule:

150°/h to 555°, Soak 15 min
250°/h to 820°, Soak 30 min
Full to 516°, Soak 2 hours
6°/h to 488°, Soak 30 min
10°/h to 388°
25°/h to 50° OFF

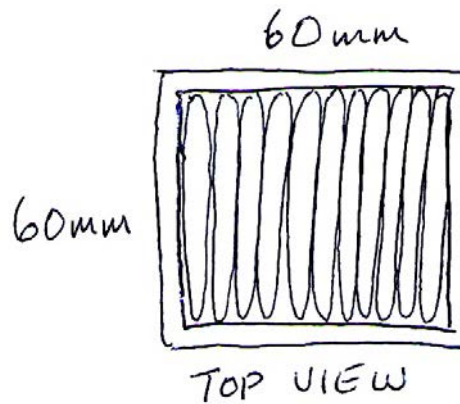

Notes:

The purpose of the test was to observe any movement of fused lines in the elements, which were tightly packed inside the mould.

The black and white elements were placed vertically and tightly packed inside the square mould. The result shows ink-like saturation without much line movement. 6x6x6cm. Photos: Sheila Labatt



TEST #41

Materials:

Bullseye Tekta,
Black Opal (0100)

Mould Type:

Ceraboard

Firing Type:

Kiln casting

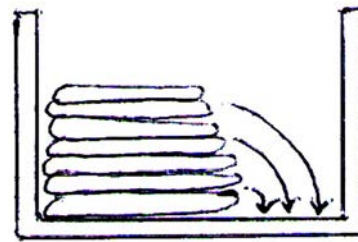

SIDE VIEW
MOVEMENT

Firing Schedule:

150°/h to 555°, Soak 15 min
250°/h to 820°, Soak 30 min
Full to 516°, Soak 2 hours
6°/h to 488°, Soak 30 min
10°/h to 388°
25°/h to 50° OFF

Notes:

The purpose of the test was to observe the effect of flow on fused grid elements.

The elements were laid horizontally inside the mould. The result shows strong, dense ink-like marks and movement of the grid across two axes. 10x7x4cm.

Photos: Sheila Labatt

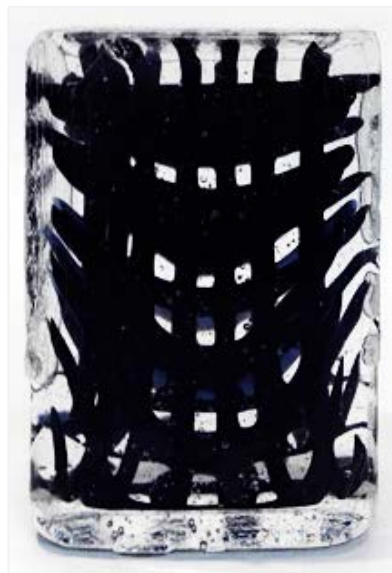

TEST #42

Materials:

Bullseye Tekta,
Black Opal (0100)

Mould Type:

Ceraboard

Firing Type:

Kiln casting

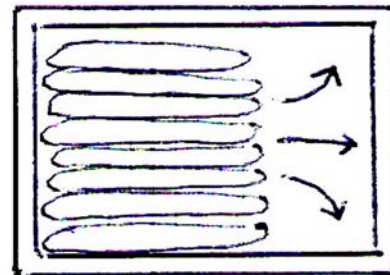

TOP VIEW
MOVEMENT

Firing Schedule:

150°/h to 555°, Soak 15 min
250°/h to 820°, Soak 30 min
Full to 516°, Soak 2 hours
6°/h to 488°, Soak 30 min
10°/h to 388°
25°/h to 50° OFF

Notes:

The purpose of the test was to observe the effect of flow on fused grid elements.

The elements were stood vertically and lengthwise inside the mould. The result shows strong, ink-like yet disconnected marks. 10x7x4cm. Photos: Sheila Labatt

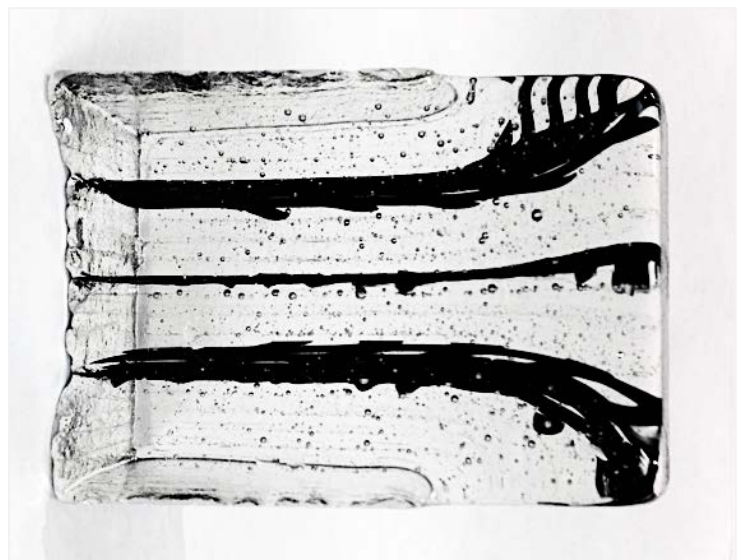

TEST #43

Materials:

Bullseye Tekta,
Black Opal (0100)

Mould Type:

Ceraboard

Firing Type:

Kiln casting

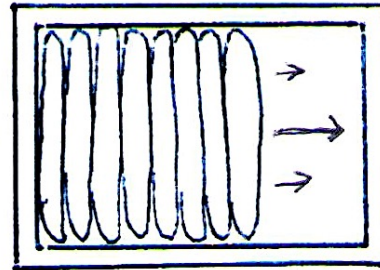

TOP VIEW
MOVEMENT

Firing Schedule:

150°/h to 555°, Soak 15 min
250°/h to 820°, Soak 30 min
Full to 516°, Soak 2 hours
6°/h to 488°, Soak 30 min
10°/h to 388°
25°/h to 50° OFF

Notes:

The purpose of the test was to observe the effect of flow on fused grid elements.

The elements were placed to stand vertically and crosswise inside the mould. The result shows strong, ink-like marks and good tapering towards the edges of the piece. 10x7x4cm. Photos: Sheila Labatt

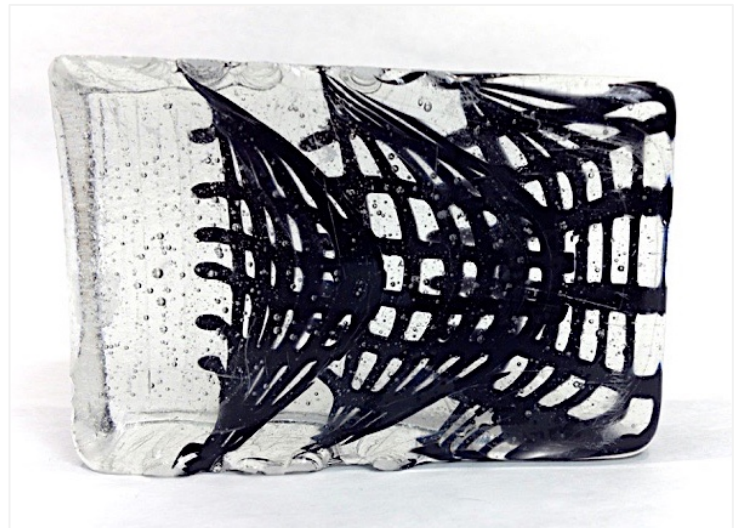

TEST #44

Materials:

Bullseye Tekta,
Black Opal (0100)

Mould Type:

Ceraboard

Firing Type:

Kiln casting

Firing Schedule:

150°/h to 555°, Soak 15 min
250°/h to 820°, Soak 30 min
Full to 516°, Soak 2 hours
6°/h to 488°, Soak 30 min
10°/h to 388°
25°/h to 50° OFF

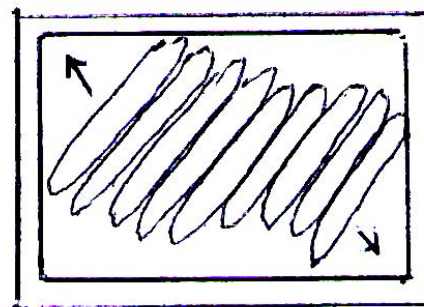

TOP VIEW
MOVEMENT

Notes:

The purpose was to observe the effect of flow on a fused grid design.

The elements were stood vertically and diagonally inside the mould. The result shows strong, ink-like yet disconnected lines. 10x7x4cm. Photos: Sheila Labatt



TEST #45

Materials:

Bullseye Tekta,
Black Opal (0100),
White Opal (0113),
Tomato Red (0024)

Mould Type:

Ceraboard

Firing Type:

Kiln casting

Firing Schedule:

150°/h to 555°, Soak 15 min
250°/h to 820°, Soak 30 min
Full to 516°, Soak 2 hours
6°/h to 488°, Soak 30 min
10°/h to 388°
25°/h to 50° OFF

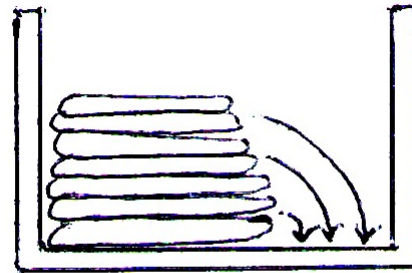

SIDE VIEW
MOVEMENT

Notes:

The purpose of the test was to observe the effect of flow on fused, 'fan' design elements.

The elements were stacked horizontally inside the mould. The result shows strong, rhythmic lines. 10x7x4cm. Photos: Sheila Labatt



TEST #46

Materials:

Bullseye Tekta,
Black Opal (0100),
White Opal (0113),
Tomato Red (0024)

Mould Type:

Ceraboard

Firing Type:

Kiln casting

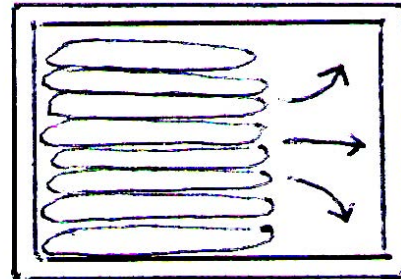

TOP VIEW
MOVEMENT

Firing Schedule:

150°/h to 555°, Soak 15 min
250°/h to 820°, Soak 30 min
Full to 516°, Soak 2 hours
6°/h to 488°, Soak 30 min
10°/h to 388°
25°/h to 50° OFF

Notes:

The purpose of the test was to observe the effect of flow on the fused 'fan' design elements.

The elements were stood vertically and lengthwise inside the mould. The result shows strong, curving yet disconnected lines. 10x7x4cm. Photos: Sheila Labatt

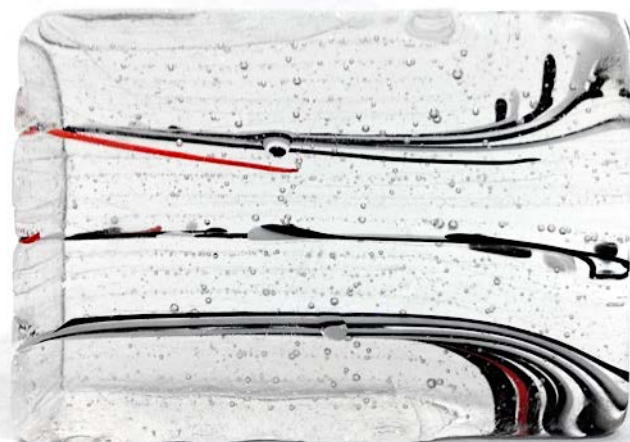

TEST #47

Materials:

Bullseye Tekta,
Black Opal (0100),
White Opal (0113),
Tomato Red (0024)

Mould Type:

Ceraboard

Firing Type:

Kiln casting

Firing Schedule:

150°/h to 555°, Soak 15 min
250°/h to 820°, Soak 30 min
Full to 516°, Soak 2 hours
6°/h to 488°, Soak 30 min
10°/h to 388°
25°/h to 50° OFF

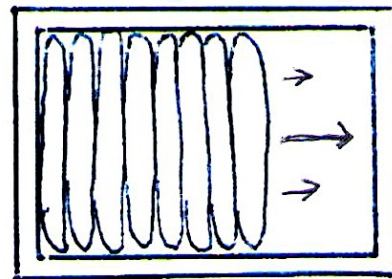

TOP VIEW
MOVEMENT

Notes:

The purpose was to observe the effect of flow on the fused, 'fan' design of the elements.

The elements were stood vertically and crosswise inside the mould. The result shows strong, graceful, curving lines. 10x7x4cm. Photos: Sheila Labatt



TEST #48

Materials:

Bullseye Tekta,
Black Opal (0100),
White Opal (0113),
Tomato Red (0024)

Mould Type:

Ceraboard

Firing Type:

Kiln casting

Firing Schedule:

150°/h to 555°, Soak 15 min
250°/h to 820°, Soak 30 min
Full to 516°, Soak 2 hours
6°/h to 488°, Soak 30 min
10°/h to 388°
25°/h to 50° OFF

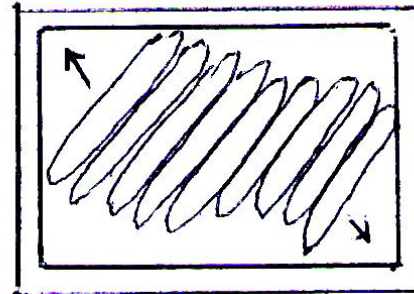

TOP VIEW
MOVEMENT

Notes:

The purpose was to prepare elements with a fused, fan shape design for use in kiln casting.

The elements were stood both vertically and diagonally inside the mould. The result shows curved, saturated yet disconnected lines. 10x7x4cm. Photos: Sheila Labatt



TEST #49

Materials:

Bullseye Tekta,
Black Opal (0100),
Spring Green Opal (0126)

Mould Type:

ThinFire paper

Firing Type:

Fusing

Firing Schedule:

300°/h to 820°, Soak 10 min
Full to 515°
Soak 10 min OFF

Notes:

The purpose was to prepare fused, parallel line elements for kiln casting.

The results show that the parallel stringers fired cleanly and stayed in place during firing. 60x60x6mm. Photos: Sheila Labatt

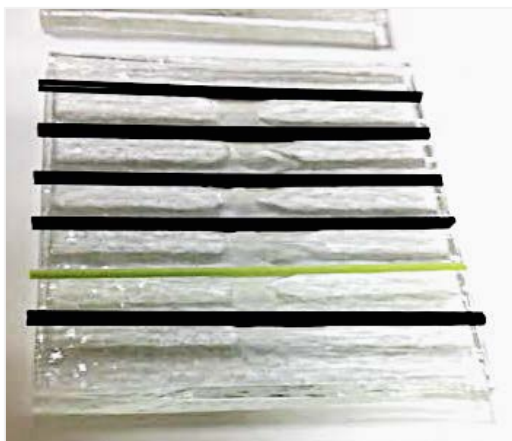

TEST #50

Materials:

Bullseye Tekta,
Black Opal (0100),
Spring Green Opal (0126)

Mould Type:

Ceraboard

Firing Type:

Kiln casting

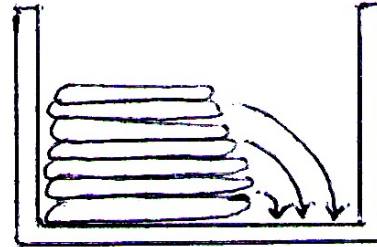

SIDE VIEW
MOVEMENT

Firing Schedule:

150°/h to 555°, Soak 15 min
250°/h to 820°, Soak 30 min
Full to 516°, Soak 2 hours
6°/h to 488°, Soak 30 min
10°/h to 388°
25°/h to 50° OFF

Notes:

The purpose was to observe the effect of flow on a loose grid assembly of fused line elements.

The parallel line fused elements were stacked horizontally inside the mould. Each element was turned 90° from its neighbour to create a loose grid. The result shows strong, dense, curving, ink-like marks. 10x7x4cm. Photos: Sheila Labatt

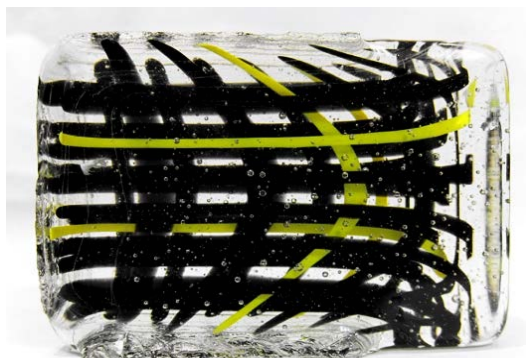
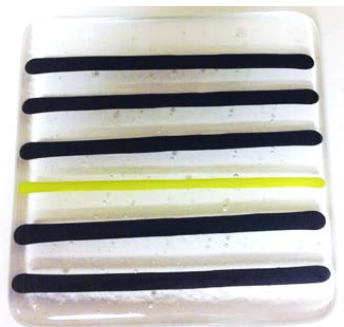

TEST #51

Materials:

Bullseye Tekta,
Black Opal (0100),
Spring Green Opal (0126)

Mould Type:

Ceraboard

Firing Type:

Kiln casting

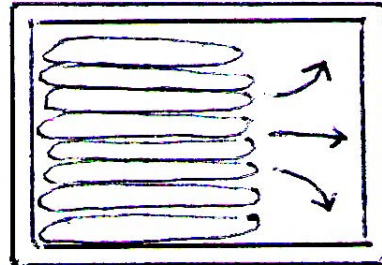

TOP VIEW
MOVEMENT

Firing Schedule:

150°/h to 555°, Soak 15 min
250°/h to 820°, Soak 30 min
Full to 516°, Soak 2 hours
6°/h to 488°, Soak 30 min
10°/h to 388°
25°/h to 50° OFF

Notes:

The purpose of the test was to observe the effect of flow on a 'loose grid' setup of elements.

The fused parallel line elements were stood vertically and lengthwise inside the mould. Each element was turned 90° from its neighbour to create a loose grid. The result shows strong, dense, curving, ink-like marks. 10x7x4cm. Photos: Sheila Labatt

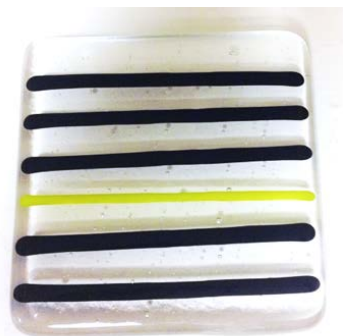

TEST #52

Materials:

Bullseye Tekta,
Black Opal (0100),
Spring Green Opal (0126)

Mould Type:

Ceraboard

Firing Type:

Kiln casting

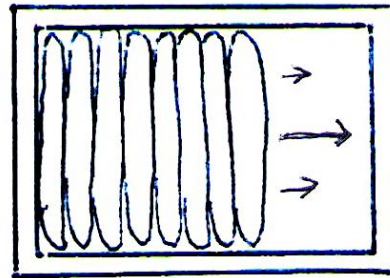

TOP VIEW
MOVEMENT

Firing Schedule:

150°/h to 555°, Soak 15 min
250°/h to 820°, Soak 30 min
Full to 516°, Soak 2 hours
6°/h to 488°, Soak 30 min
10°/h to 388°
25°/h to 50° OFF

Notes:

The purpose of the test was to observe the effects of flow on a 'loose grid' set up of elements.

The parallel line fused elements were stood vertically and crosswise inside the mould. Each element was turned 90° from its neighbour to create a loose grid. The result shows strong, dense, curving, ink-like marks and good tapering at the edges of the piece. 10x7x4cm. Photos: Sheila Labatt



TEST #53

Materials:

Bullseye Tekta,
Black Opal (0100),
Spring Green Opal (0126)

Mould Type:

Ceraboard

Firing Type:

Kiln casting

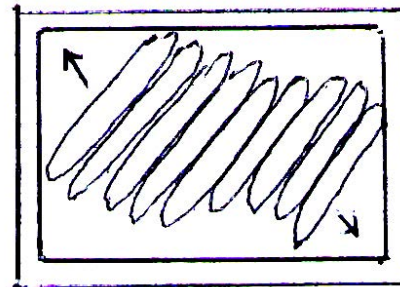

TOP VIEW
MOVEMENT

Firing Schedule:

150°/h to 555°, Soak 15 min
250°/h to 820°, Soak 30 min
Full to 516°, Soak 2 hours
6°/h to 488°, Soak 30 min
10°/h to 388°
25°/h to 50° OFF

Notes:

The purpose was to observe the effect of flow on elements assembled in a loose grid inside the mould.

Parallel line elements were stood vertically and diagonally inside the mould. The elements were each turned 90° from its neighbour to create a loose grid. The result shows strong but random ink-like marks. 10x7x4cm. Photos: Sheila Labatt

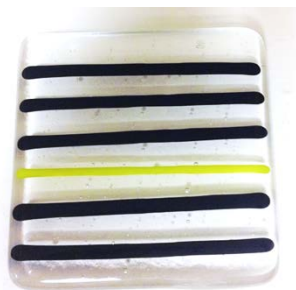

TEST #54

Materials:

Bullseye Tekta,
Black Opal (0100),
Spring Green Opal (0126)

Mould Type:

ThinFire paper

Firing Type:

Fusing

Firing Schedule:

300°/h to 820°, Soak 10 min
Full to 515°
Soak 10 min OFF

Notes:

The purpose was to prepare loose, diagonal grid elements for kiln casting.

The result shows that the lines remained clean and saturated and properly situated in the finished element. 60x60x6mm. Photos: Sheila Labatt

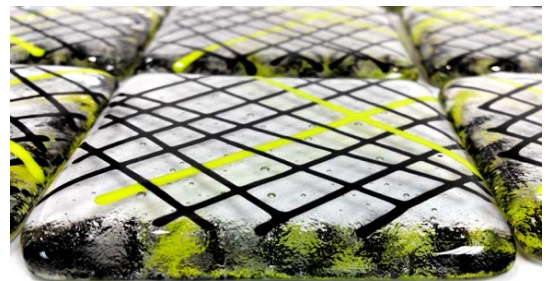
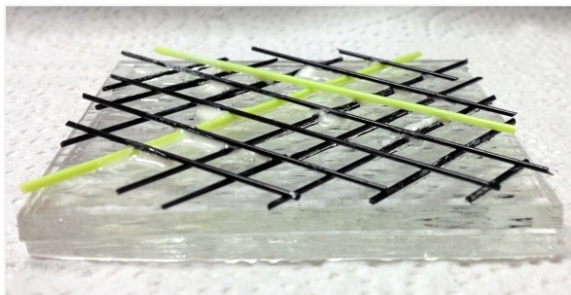

TEST #55

Materials:

Bullseye Tekta,
Black Opal (0100),
Spring Green Opal (0126)

Mould Type:

Ceraboard

Firing Type:

Kiln casting

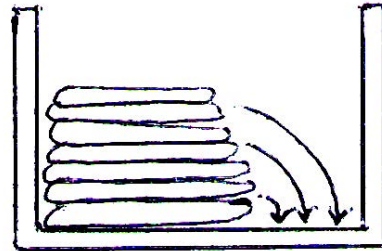

SIDE VIEW
MOVEMENT

Firing Schedule:

150°/h to 555°, Soak 15 min
250°/h to 820°, Soak 30 min
Full to 516°, Soak 2 hours
6°/h to 488°, Soak 30 min
10°/h to 388°
25°/h to 50° OFF

Notes:

The purpose was to observe the effect of flow on the diagonal grid design fused into the elements.

The elements were stacked horizontally inside the mould. The result shows strong, dense, curving, ink-like marks. 10x7x4cm. Photos: Sheila Labatt

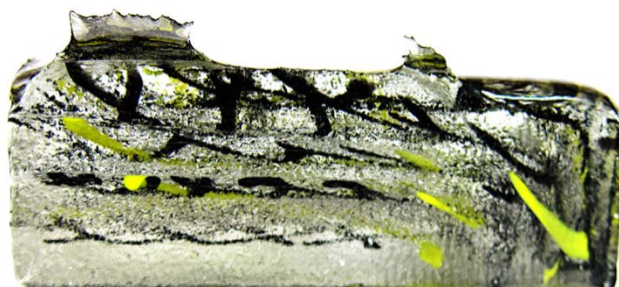
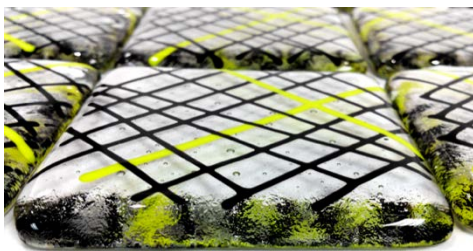

TEST #56

Materials:

Bullseye Tekta,
Black Opal (0100),
Spring Green Opal (0126)

Mould Type:

Ceraboard

Firing Type:

Kiln casting

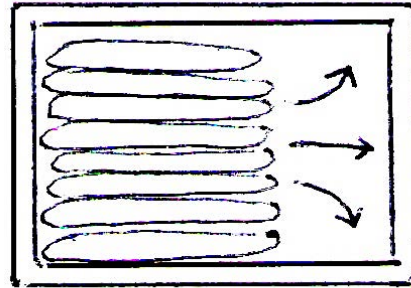

TOP VIEW
MOVEMENT

Firing Schedule:

150°/h to 555°, Soak 15 min
250°/h to 820°, Soak 30 min
Full to 516°, Soak 2 hours
6°/h to 488°, Soak 30 min
10°/h to 388°
25°/h to 50° OFF

Notes:

The purpose was to observe the effect of flow on 'diagonal grid' design fused into the elements.

The elements were stood vertically and lengthwise inside the mould. The result produced saturated and slightly curving but otherwise unremarkable lines.
10x7x4cm. Photos: Sheila Labatt

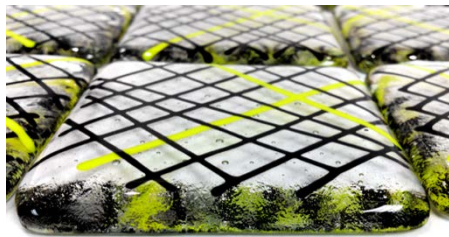

TEST #57

Materials:

Bullseye Tekta,
Black Opal (0100),
Spring Green Opal (0126)

Mould Type:

Ceraboard

Firing Type:

Kiln casting

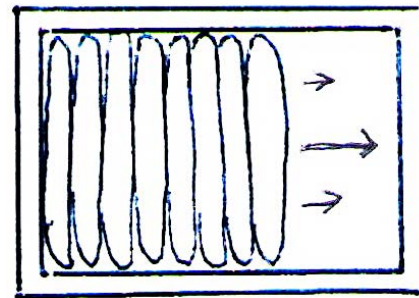

TOP VIEW
MOVEMENT

Firing Schedule:

150°/h to 555°, Soak 15 min
250°/h to 820°, Soak 30 min
Full to 516°, Soak 2 hours
6°/h to 488°, Soak 30 min
10°/h to 388°
25°/h to 50° OFF

Notes:

The purpose of the test was to evaluate the effect of flow on a 'diagonal grid' design fused into elements.

The elements were stood vertically and crosswise inside the mould. The result shows strong, dense, loose, slightly curving grid-like marks. 10x7x4cm. Photos: Sheila Labatt

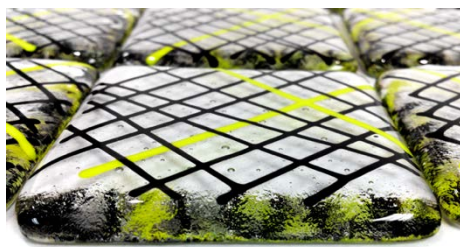

TEST #58

Materials:

Bullseye Tekta,
Black Opal (0100),
Spring Green Opal (0126)

Mould Type:

Ceraboard

Firing Type:

Kiln casting

Firing Schedule:

150°/h to 555°, Soak 15 min
250°/h to 820°, Soak 30 min
Full to 516°, Soak 2 hours
6°/h to 488°, Soak 30 min
10°/h to 388°
25°/h to 50° OFF

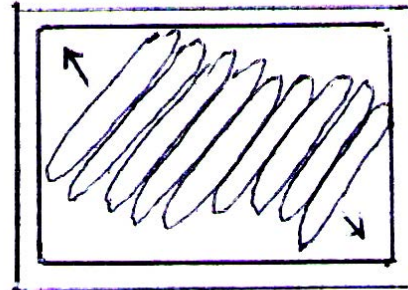

TOP VIEW
MOVEMENT

Notes:

The purpose was to observe the effect of flow on 'diagonal grid' fused elements.

The elements were stood vertically and diagonally inside the mould to allow for flow in four directions. The result is unremarkable. 10x7x4cm. Photos: Sheila Labatt

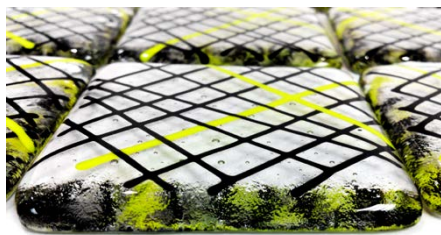

TEST #59

(*Out of the Box III*, 2015)

Materials:

Glasma Furnace Glass
Gaffer Black (G050),
Vermillion (G176),
Ivory (G102)

Mould Type:

Plaster, silica, fibreglass

Firing Type:

Hot casting

Firing Schedule:

Glass introduced at 600°
Full to 900°, Soak 2 hours
Full to 500°, Soak 16 hours
6°/h to 320°, Soak 6 hours
10°/h to 200°, Soak 5 hours
25°/h to 50° OFF

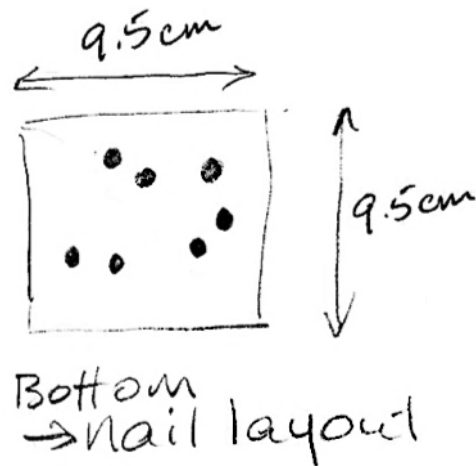

Notes:

The purpose was to observe the effect of bubble running, through the use of a 'nail plunger', on frameworked inclusions, during the hot casting process.

Gathers and frameworked cane inclusions were placed into the mould and a wooden plunger (9.5x9.5cm head) with nails was pushed into each gather of molten glass to create trapped air pockets which would rise as bubbles. The result was a block with strong, gestural, ink-like inclusions. 15x10x10cm.

Photos: Sheila Labatt and Ester Segarra



TEST #60

(Out of the Box II, 2015)

Materials:

Glasma Furnace Glass
Gaffer Black (G050),
Vermillion (G176),
Ivory (G102)

Mould Type:

Plaster, silica

Firing Type:

Hot casting

Firing Schedule:

Glass introduced at 600°
Full to 900°, Soak 2 hours
Full to 500°, Soak 16 hours
6°/h to 320°, Soak 6 hours
10°/h to 200°, Soak 5 hours
25°/h to 50° OFF

Notes:

The purpose was to observe the effect of bubble running, using baking soda, on frameworked inclusions, during the hot casting process.

Two pinches of sodium bicarbonate were sprinkled on the bottom of the mould prior to the introduction of hot glass gathers and small, frameworked cane inclusions. The result is that the sodium bicarbonate released bubbles into the hot glass and left behind long, gestural ink-like lines as well as an abundance of seed bubbles. 15x10x10cm. Photo: Ester Segarra



TEST #61

(Out of the Box, 2015)

Materials:

Glasma Furnace Glass
Gaffer Black (G050),
Vermillion (G176),
Ivory (G102)

Mould Type:

Plaster, silica, fibreglass

Firing Type:

Hot casting

Firing Schedule:

Glass introduced at 600°
Full to 900°, Soak 2 hours
Full to 500°, Soak 16 hours
6°/h to 320°, Soak 6 hours
10°/h to 200°, Soak 5 hours
25°/h to 50° OFF

Notes:

The purpose was to assess the effect of 'bubble running' on inclusions during hot casting.

Holes of Ø5mm each in bottom of mould were created using the lost wax process. Gathers and flameworked cane inclusions were introduced into the mould, causing air to become trapped inside the holes by the hot glass. The result is that the bubbles, created by the trapped air, caused good movement inside the block and gave rise to strong, gestural, calligraphic, ink-like inclusions. See Results section in thesis. 15x10x10cm. Photos: Sheila Labatt and Sylvain Deleu

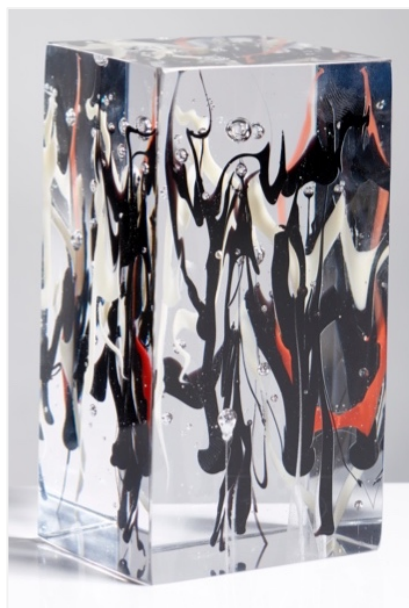

TEST #62

Materials:

Glasma Furnace Glass
Gaffer Black (G050),
Vermillion (G176),
Ivory (G102)

Mould Type:

Steel mould on marver

Firing Type:

Annealing

Firing Schedule:

Into lehr at 500°, Soak 12 hours
6°/h to 320°, Soak 6 hours
10°/h to 200°
25°/h to 50° OFF

Notes:

The purpose of the test was to see whether straight could be sufficiently manipulated in hot glass to yield three dimensional, ink-like, calligraphic marks.

Straight, tapered flameworked cane inclusions were added, between gathers during hot casting, and manipulated with long tweezers. No bubbles were run through this piece. The result is one evoking three-dimensional, ink-like inclusions. 20x10x6cm. Photos: Sheila Labatt



TEST #63

Materials:

Bullseye Tekta,
Black Opal (0100),
Tomato Red (0024),
White Opal (0113)

Mould Type:

ThinFire paper

Firing Type:

Fusing

Firing Schedule:

300°/h to 820°, Soak 10 min
Full to 515°, Soak 10 min
OFF

Notes:

The purpose was to fuse tapered fan designs into clear elements for casting.

The tips of the coloured stringers were flameworked to create tapered tips in order to yield elegant, calligraphic ends. When fused stringers are not tapered, they yield rounded ends. The results show that the tips taper only slightly and are still fairly rounded. 60x60x6mm. Photos: Sheila Labatt



TEST #64

Materials:

Bullseye Tekta,
Charcoal Grey (A076)

Mould Type:

ThinFire paper

Firing Type:

Fusing

Firing Schedule:

300°/h to 820°, Soak 10 min
Full to 515°, Soak 10 min OFF

Notes:

The purpose is to prepare elements for casting, using a thin but uneven application of dark grey powder and is a test to see whether the element alone can evoke brush and ink wash.

The result reveals that there are gradations of grey between where the powder was thicker and where it was thinner, evoking a 'wash' effect. The darks, however, do not are not a fully saturated black, as would be desired in brush and ink painting. 60x60x6mm. Photos: Sheila Labatt



TEST #65

Materials:

Bullseye Tekta,
Black Opal (0100),
Tomato Red (0024),
White Opal (0113)

Mould Type:

Kiln bricks lined with fibre paper

Firing Type:

Kiln casting

Firing Schedule:

150°/h to 555°, Soak 15 min
250°/h to 820°, Soak 30 min
Full to 516°, Soak 2 hours
6°/h to 488°, Soak 30 min
10°/h to 388°
25°/h to 50° OFF

Notes:

The purpose was to observe the effect of four way flow on the fan design fused into the elements.

The elements were stacked horizontally, at 90° turns to each other and in the centre of the mould, such that the glass would flow in four directions. The result shows very little apparent movement as compared to tests where the flow is in one direction only. Flat bubbles were trapped between the elements, indicating that the glass layers may only be fused and not fully melted at 820°. 10x10x3cm. Photos: Sheila Labatt



TEST #66

Materials:

Bullseye Tekta,
Black Opal (0100),
Tomato Red (0024),
White Opal (0113)

Mould Type:

Kiln bricks lined with fibre paper

Firing Type:

Kiln casting

Firing Schedule:

150°/h to 555°, Soak 15 min
250°/h to 820°, Soak 30 min
Full to 516°, Soak 2 hours
6°/h to 488°, Soak 30 min
10°/h to 388°
25°/h to 50° OFF

Notes:

The purpose was to observe the effect of flow on the fan design fused into the elements.

The elements were placed vertically, diagonally and at 90° turns to each other in the middle of the mould, such that the glass would flow in four directions. The kiln underfired resulting in a semi-cast object which, nevertheless, shows flowing, ink-like marks, which are optically enhanced by folds in the outer skin of the piece. Approx. 10x10x3cm. Photos: Sheila Labatt



TEST #67

Materials:

Bullseye Tekta,
Black Opal (100),
Tomato Red (124),
White Opal (013)

Mould Type:

Fire bricks lined
With 1mm fibre paper

Firing Type:

Kiln casting

Firing Schedule:

150°/h to 555°, Soak 10 min
250°/h to 820°, Soak 30 min
Full to 516°, Soak 6 hours
50°/h to 488°, Soak 2 hours
15°/h to 388°, Soak 1 hour OFF

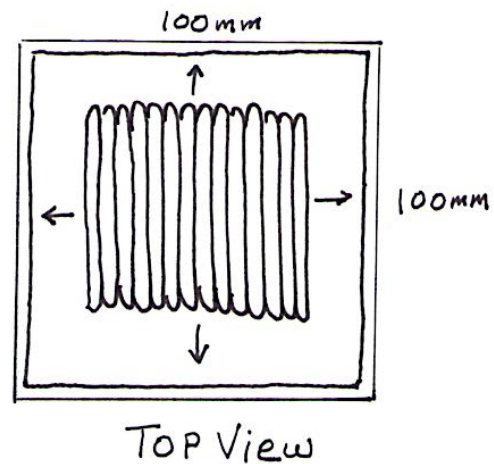

Notes:

The purpose was to observe the effect of flow on the fan design in the fused elements.

The elements were placed vertically in the centre of a square mould that would allow the glass to flow in four directions. The result shows an unremarkable arrangement of fairly straight lines. 10x10x3cm. Photos: Sheila Labatt



TEST #68

Materials:

Bullseye Tekta,
Black Opal (100),
Tomato Red (124),
White Opal (013)

Mould Type:

Ceraboard

Firing Type:

Kiln casting

Firing Schedule:

150°/h to 555°, Soak 10 min
250°/h to 820°, Soak 30 min
Full to 516°, Soak 6 hours
50°/h to 488°, Soak 2 hours
15°/h to 388°, Soak 1 hour OFF

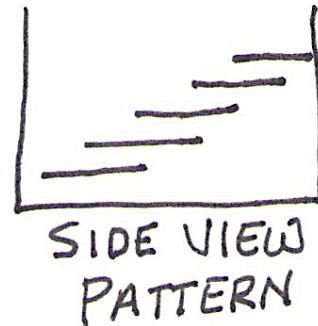

Notes:

The purpose was to observe the effect of flow on the fan-design in the elements.

The elements were stacked horizontally and lengthwise, in staircase fashion and were each turned 90° from the previous element in the stack. Good 'hēng 哼' stroke, in Standard script calligraphy (circled in red). 10x7x4cm. Photos: Sheila Labatt



TEST #69

Materials:

Bullseye Tekta,
Black Opal (100),
Tomato Red (124),
White Opal (013)

Mould Type:

Ceraboard

Firing Type:

Kiln casting

Firing Schedule:

150°/h to 555°, Soak 10 min
250°/h to 820°, Soak 30 min
Full to 516°, Soak 6 hours
50°/h to 488°, Soak 2 hours
15°/h to 388°, Soak 1 hour OFF

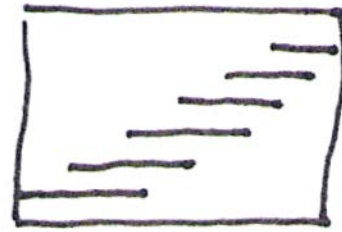

TOP VIEW
PATTERN

Notes:

The purpose was to observe the effect of flow on the design of the elements.

The fused elements were placed vertically, in staircase fashion and turned 90° each from its neighbouring element. The result shows unremarkable movement in the lines. 10x7x4cm. Photos: Sheila Labatt



TEST #70

Materials:

Bullseye Tekta,
Black Opal (100),
Tomato Red (124),
White Opal (013)

Mould Type:

Ceraboard

Firing Type:

Kiln casting

Firing Schedule:

150°/h to 555°, Soak 10 min
250°/h to 820°, Soak 30 min
Full to 516°, Soak 6 hours
50°/h to 488°, Soak 2 hours
15°/h to 388°, Soak 1 hour OFF

Notes:

The purpose was to assess the effect of flow on the fan-shape design fused into the elements.

The elements were stacked vertically, lengthwise and offset, with 90° turns of each element from its neighbouring one. The result shows a good 'piē 瞥' stroke in Standard script calligraphy (circled in blue). 10x7x4cm. Photos: Sheila Labatt

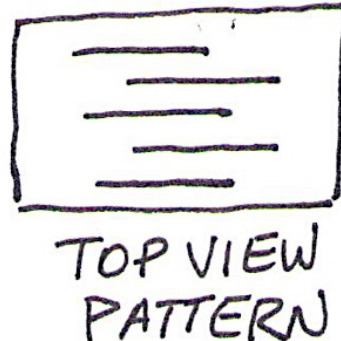

TEST #71

Materials:

Bullseye Tekta,
Black Opal (100),
Tomato Red (124),
White Opal (013)

Mould Type:

Ceraboard

Firing Type:

Kiln casting

Firing Schedule:

150°/h to 555°, Soak 10 min
250°/h to 820°, Soak 30 min
Full to 516°, Soak 6 hours
50°/h to 488°, Soak 2 hours
15°/h to 388°, Soak 1 hour OFF

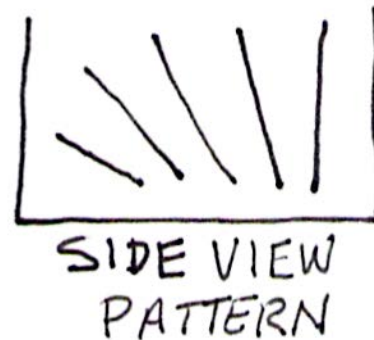

Notes:

The purpose was to observe the effects of flow on the fused lines in the elements.

The elements were placed vertically and leaning to one side inside the mould. Each element was turned 90° from its neighbour. The result shows little flow on the straight lines. 10x7x4cm. Photos: Sheila Labatt



TEST #72

Materials:

Bullseye Tekta,
Charcoal Grey (A096)

Mould Type:

Ceraboard

Firing Type:

Kiln casting

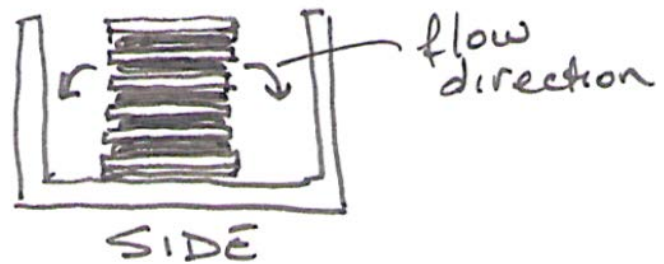

Firing Schedule:

150°/h to 555°, Soak 10 min
250°/h to 820°, Soak 1 hour
Full to 516°, Soak 2.5 hours
50°/h to 488°, Soak 1 hour
15°/h to 388, Soak 10 min OFF

Notes:

The purpose was to evoke brush and ink landscape painting through the effects of flow.

The elements were stacked, lying flat on the bottom and in the centre of the mould, for two-way flow. The result shows that the grey, transparent powder colour remained pale and yielded poor contrast. 10x7x4cm. Photos: Sheila Labatt



TEST #73

Materials:

Bullseye Tekta,
Charcoal Grey (A096)

Mould Type:

Ceraboard

Firing Type:

Kiln casting

Firing Schedule:

150°/h to 555°, Soak 10 min

250°/h to 820°, Soak 1 hour

Full to 516°, Soak 2.5 hours

50°/h to 488°, Soak 1 hour

15°/h to 388, Soak 10 min OFF

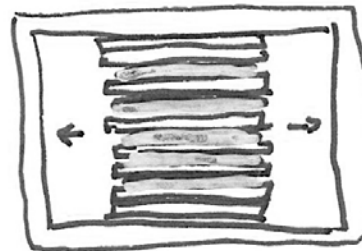

Top View

Notes:

The purpose was to explore the effect of flow on the fused powder design in the elements.

The elements were stacked vertically and lengthwise for a two-way flow. The result evokes brush and ink landscape painting, albeit without the tonal range of black 'ink' inclusions. 10x7x4cm. Photos: Sheila Labatt

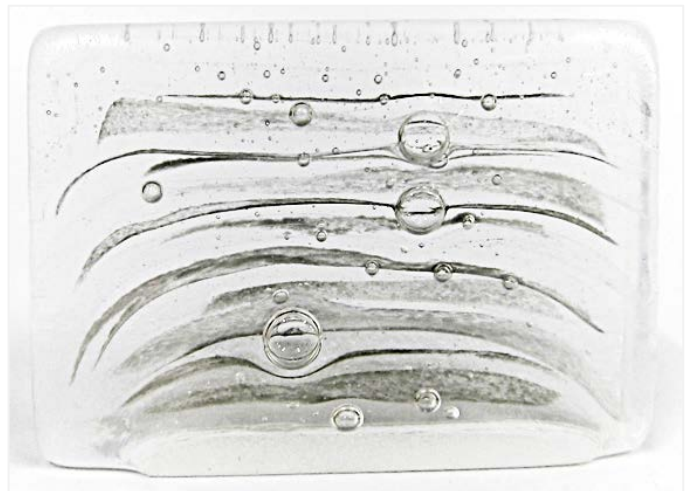

TEST #74

Materials:

Bullseye Tekta,
Charcoal Grey (A096)

Mould Type:

Ceraboard

Firing Type:

Kiln casting

Firing Schedule:

150°/h to 555°, Soak 10 min
250°/h to 820°, Soak 1 hour
Full to 516°, Soak 2.5 hours
50°/h to 488°, Soak 1 hour
15°/h to 388, Soak 10 min OFF

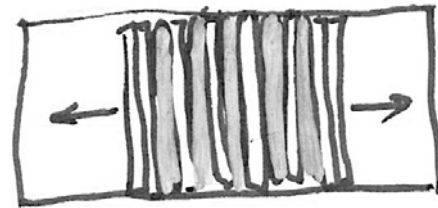

Top view

Notes:

The purpose is to observe the effect of flow on the fused powder design on the elements.

The elements fused with charcoal grey powder were arranged vertically and crosswise inside the mould for two-way flow. The result evokes vertical format Chinese landscape painting. The grey scale range and contrast, however, are weak. 10x7x4cm. Photos: Sheila Labatt

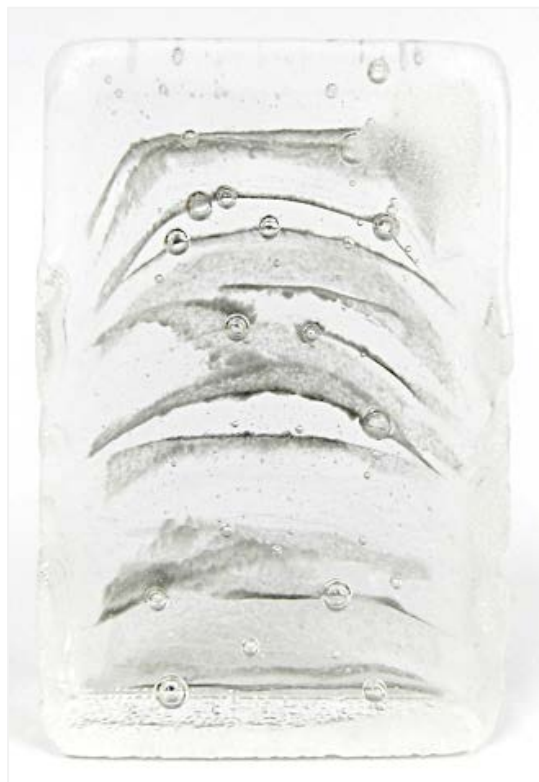

TEST #75

Materials:

Bullseye Tekta,
Charcoal Grey (A096)

Mould Type:

Ceraboard

Firing Type:

Kiln casting

Firing Schedule:

150°/h to 555°, Soak 10 min
250°/h to 820°, Soak 1 hour
Full to 516°, Soak 2.5 hours
50°/h to 488°, Soak 1 hour
15°/h to 388, Soak 10 min OFF

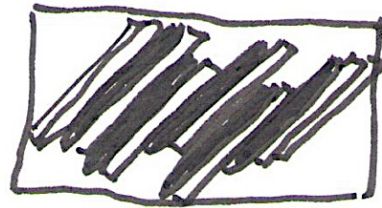

Top

Notes:

The purpose was to observe the effect of flow on elements.

The elements with fused grey 'wash' were arranged vertically inside the mould and on a staggered diagonal to flow in two directions. 10x7x4cm. Photos: Sheila Labatt



TEST #76

Materials:

Bullseye Tekta,
Charcoal Grey (A096)

Mould Type:

ThinFire paper

Firing Type:

Fusing

Firing Schedule:

400°/h to 800°, Soak 10 min
Full to 516°, Soak 10 min OFF

Notes:

The purpose of the test is to assess the effect of fusing broken grey eggshells onto clear Tekta slides to create elements for casting.

The result evokes ink wash. The transparency of the grey yields visual depth and a variety of densities of grey. The blacks, however, are not as saturated as when black is used in the eggshells. Black use in eggshells also yields a more neutral grey. 60x60x6mm. Photos: Sheila Labatt

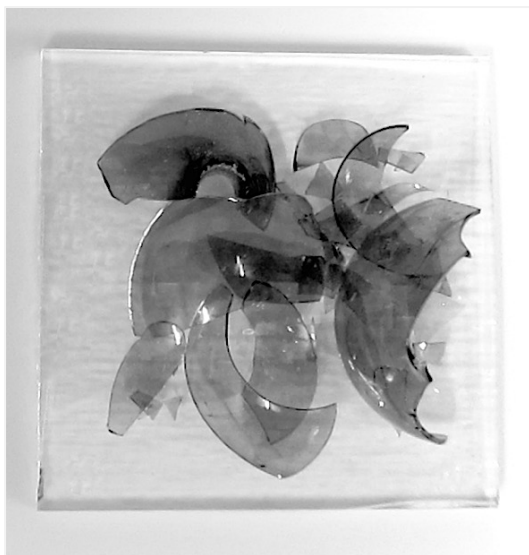

TEST #77

Materials:

Bullseye Tekta,
Clear Transparent (1101),
Black Opal (100)

Mould Type:

ThinFire paper

Firing Type:

Fusing

Firing Schedule:

400°/h to 800°, Soak 10 min
Full to 516°, Soak 10 min OFF

Notes:

The purpose of the test is to observe the effect of fusing broken clear and black stringer eggshells onto clear Tekta slides to create elements for casting.

The result evokes dramatic ink wash. The transparency in the eggshells yield visual depth and a good variety of densities of grey and black. Good contrast is also seen through grey scale range, circled in red. 60x60x6mm. Photos:
Sheila Labatt



TEST #78

Materials:

Bullseye Tekta,
Clear Transparent (1101),
Black Opal (100)

Mould Type:

ThinFire paper

Firing Type:

Fusing

Firing Schedule:

400°/h to 800°, Soak 10 min
Full to 516°, Soak 10 min OFF

Notes:

The purpose was to observe the effect of fusing broken clear and black powder eggshells onto clear Tekta slides to create elements for casting.

The result nicely evokes ink wash. The transparency in the eggshells yields visual depth and a variety of densities of clear through to grey to black. Good contrast can also be seen through the range of grey scale, circled in red. 60x60x6mm. Photos: Sheila Labatt



TEST #79

Materials:

Bullseye Tekta,
Stiff Black (101),
White Opal (103)

Mould Type:

ThinFire paper

Firing Type:

Fusing

Firing Schedule:

400°/h to 800°, Soak 10 min
Full to 516°, Soak 10 min OFF

Notes:

The purpose of the test was to observe the effect of using broken, white and stiff black rod eggshells onto clear Tekta slides to create elements for casting.

The result evokes ink wash. Good, inky contrast can be seen through ranges of grey scale, circled in red. 60x60x6mm. Photos: Sheila Labatt

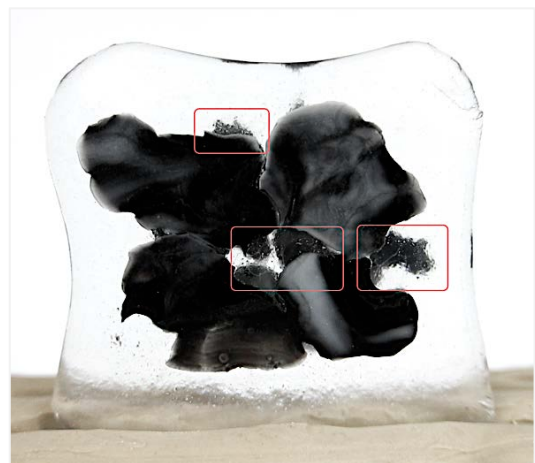

TEST #80

Materials:

Bullseye Tekta,
Black Opal (100)

Mould Type:

ThinFire paper

Firing Type:

Fusing

Firing Schedule:

400°/h to 800°, Soak 10 min
Full to 516°, Soak 10 min OFF

Notes:

The purpose of the test was to observe the effect of black 'confetti' onto clear Tekta slides.

The results show 'ink wash' with solid black 'inky' outlines. 60x60x6mm. Photos: Sheila Labatt



TEST #81

Materials:

Bullseye Tekta,
Black Opal (100)

Mould Type:

ThinFire paper

Firing Type:

Fusing

Firing Schedule:

400°/h to 800°, Soak 10 min
Full to 516°, Soak 10 min OFF

Notes:

The purpose was to fuse irregularly sized frit onto elements and assess the result.

Both coarse and fine black frit were fused into clear Tekta slides. The results show irregular shapes and sizes of marks evoking various types of 'dots' (diǎn 点), seen in Chinese calligraphy. 60x60x6mm. Photo: Sheila Labatt

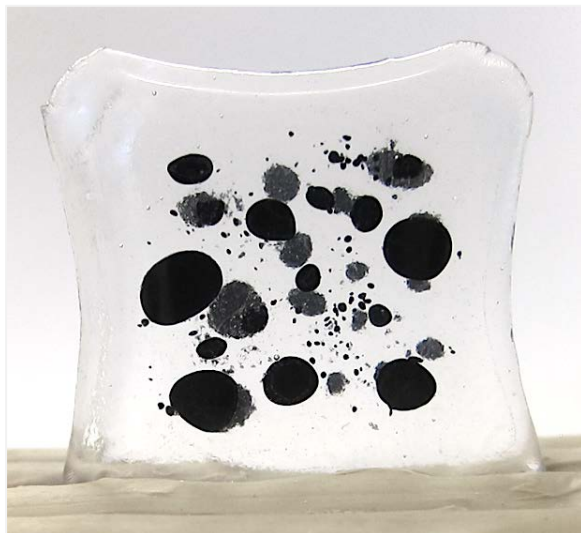

TEST #82

Materials:

Bullseye Tekta,
Black Opal (100),
Clear Transparent (1101),
Light Silver (1429),
Charcoal Grey (1129)

Mould Type:

Ceraboard

Firing Type:

Kiln casting

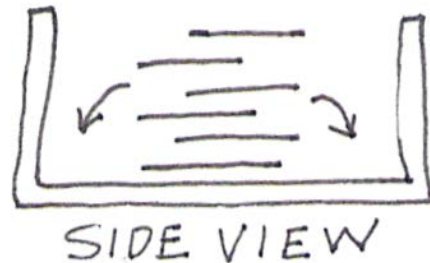

Firing Schedule:

100°/h to 555°, Soak 1 hour
200°/h to 820°, Soak 2.5 hours
Full to 516, Soak 3 hours
10°/h to 488°, Soak 1 hour
50°/h to 388°, Soak 2 hours
50°/h to 150°, Soak 1 hour OFF

Notes:

The purpose is to assess the effect of flow on elements with fused ink-like marks.

The elements were stacked horizontally in the mould and slightly staggered to flow in two directions. The results show a good ink-like effect, particularly where circled in red. 10x7x4cm. Photos: Sheila Labatt



TEST #83

Materials:

Bullseye Tekta,
Black Opal (100),
Clear Transparent (1101)

Mould Type:

Ceraboard

Firing Type:

Kiln casting



Firing Schedule:

100°/h to 555°, Soak 1 hour
200°/h to 820°, Soak 2.5 hours
Full to 516, Soak 3 hours
10°/h to 488°, Soak 1 hour
50°/h to 388°, Soak 2 hours
50°/h to 150°, Soak 1 hour OFF

Notes:

The purpose was to assess the effect of flow on elements with fused, saturated ink-like fields.

The elements were arranged standing vertically and staggered lengthwise inside the mould to flow in two directions. The result shows strong 'ink' saturation evoking Chinese brush and ink landscape painting of mountains rising from the mist. The fired piece also evokes the Northeast Asian cloud motif, circled in red. 10x7x4cm. Photos: Sheila Labatt



TEST #84

Materials:

Bullseye Tekta,
Clear Transparent (1101),
Black Opal (0100),
White Opal (0113)

Mould Type:

Ceraboard

Firing Type:

Kiln casting

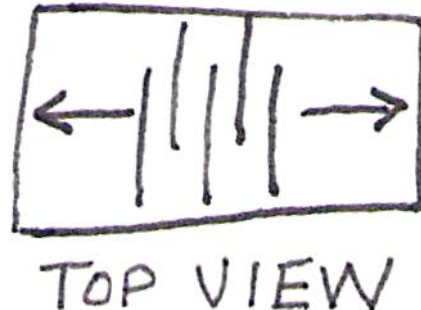

Firing Schedule:

100°/h to 555°, Soak 1 hour
200°/h to 820°, Soak 2.5 hours
Full to 516, Soak 3 hours
10°/h to 488°, Soak 1 hour
50°/h to 388°, Soak 2 hours
50°/h to 150°, Soak 1 hour OFF

Notes:

The purpose was to assess the effect of flow on elements with fused ink wash-like marks.

The elements were placed standing vertically and staggered crosswise inside the mould to flow in two directions. Good ink-like marks were displayed on the pre-cast elements, circled in red, and rendered fairly strong 'ink wash' marks post-firing. 10x7x4cm. Photos: Sheila Labatt



TEST #85

Materials:

Bullseye Tekta (1101),
Black Opal (0100)

Mould Type:

Ceraboard

Firing Type:

Kiln casting

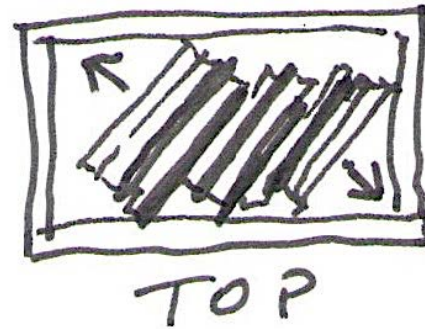

Firing Schedule:

100°/h to 555°, Soak 1 hour
200°/h to 820°, Soak 2.5 hours
Full to 516, Soak 3 hours
10°/h to 488°, Soak 1 hour
50°/h to 388°, Soak 2 hours
50°/h to 150°, Soak 1 hour OFF

Notes:

The purpose of the test was to assess the effect of flow on elements displaying good ink-like colour fields.

Ink field-like elements were arranged, standing vertically and staggered diagonally inside the mould, to flow in two directions. The result is that the cast ink marks are less engaging than the pre-cast ones. The resulting surface bubbles, however, make good lenses, circled in red, which distort the marks. 10x7x4cm. Photos: Sheila Labatt



TEST #86

Materials:

Bullseye Tekta,
Black Opal (0100),
Light Silver Grey (A045),
Charcoal Grey (A076)

Mould Type:

ThinFire paper

Firing Type:

Fusing

Firing Schedule:

300°/h to 810°, Soak 10 min
Full to 515°, Soak 10 min OFF

Notes:

The purpose of the test was to create elements for kiln casting and to see whether regular spheres would retain their symmetry upon fusing.

The black balls were created by melting coarse to medium frit inside a kiln. The frit balls up into a regular sphere under the effect of the heat. The balls were set up regularly on the element, using a grid drawn in marker that would burn out in kiln. The result was that the spheres became elongated, along with the distortion of the element itself, during the fusing process. The element distorted during firing because of its 3mm thickness, which caused it to contract. At 6mm, a Bullseye element would have retained its shape. 60x60x3mm. Photos:
Sheila Labatt

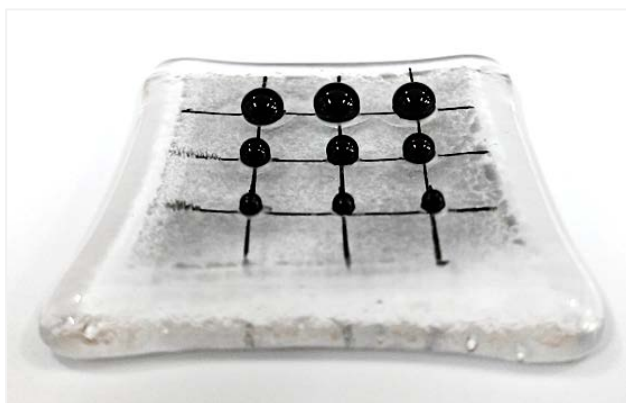

TEST #87

Materials:

Bullseye Tekta,
Black Opal (100)

Mould Type:

ThinFire paper

Firing Type:

Fusing

Firing Schedule:

300°/h to 800°, Soak 10 min
Full to 516°, Soak 10 min OFF

Notes:

The purpose was to prepare fused elements for casting, using black powder on clear Tekta.

The results show fully fused elements with a variety of saturations of the black powder. Each element is 60x60x6mm. Photos: Sheila Labatt



TEST #88

Materials:

Bullseye Tekta,
Black Opal (100)

Mould Type:

ThinFire paper

Firing Type:

Fusing

Firing Schedule:

300°/h to 800°, Soak 10 min
Full to 516°, Soak 10 min OFF

Notes:

The purpose was to prepare elements for kiln casting using black stringers, 2mm, 1mm and 0.5mm.

The result was a fully fused set of elements showing relatively straight and spaced lines. 60x60x6mm. Photos: Sheila Labatt



TEST #89

Materials:

Bullseye Tekta,
Black Opal (100),
White Opal (0013),
Tomato Red (0024)

Mould Type:

ThinFire paper

Firing Type:

Fusing

Firing Schedule:

300°/h to 800°, Soak 10 min
Full to 516°, Soak 10 min OFF

Notes:

The purpose was to prepare elements for kiln casting using unaltered (non-flameworked) black, white and red stringers.

The result shows well-fused, sharp, saturated lines. 60x60x6mm. Photos: Sheila Labatt



TEST #90

Materials:

Bullseye Tekta,
Black Opal (100),
White Opal (0013),
Tomato Red (0024)

Mould Type:

Plaster, silica, fibreglass

Firing Type:

Kiln Casting

Firing Schedule:

100°/h to 555°, Soak 15 min
200°/h to 820°, Soak 2.5 hours
Full to 516°, Soak 5 hours
10°/h to 488°, Soak 1 hour
25°/h to 388°, Soak 2 hours
50°/h to 150°, Soak 1 hour OFF

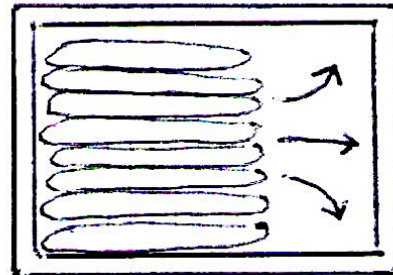

TOP VIEW
MOVEMENT

Notes:

The purpose of the test was to see how far stringers would stretch in a longer mould than is usually used during 'flow' testing.

The elements were arranged vertically and lengthwise inside the mould, each at a 90° turn from its neighbouring element. The result shows that even the thinness (0.5mm) stringers could stretch this far without losing visibility or saturation. 19x8x4cm. Photos: Sheila Labatt



TEST #91

Materials:

Bullseye Tekta,
Black Opal (100),
White Opal (0013),
Tomato Red (0024)

Mould Type:

Plaster, silica, fibreglass

Firing Type:

Kiln casting

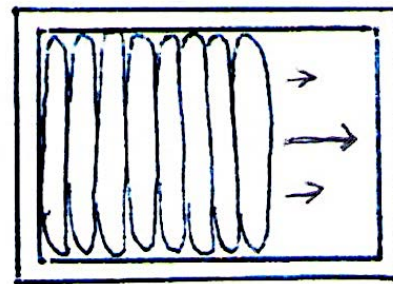

TOP VIEW
MOVEMENT

Firing Schedule:

100°/h to 555°, Soak 15 min
200°/h to 820°, Soak 2.5 hours
Full to 516°, Soak 5 hours
10°/h to 488°, Soak 1 hour
25°/h to 388°, Soak 2 hours
50°/h to 150°, Soak 1 hour OFF

Notes:

The purpose of the test was to see how far stringers would stretch in a longer mould than is usually used during 'flow' testing.

The elements were placed vertically and crosswise inside the mould, each at a 90° turn from its neighbouring element. The results show that even the thinnest (0.5mm) stringers could stretch this distance and remain both visible and saturated. 19x8x4cm. Photos: Sheila Labatt



TEST #92

Materials:

Bullseye Tekta,
Black Opal (100)

Mould Type:

Ceraboard

Firing Type:

Kiln Casting

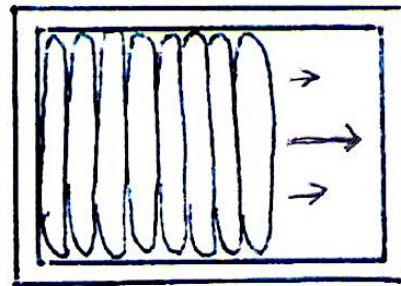

TOP VIEW
MOVEMENT

Firing Schedule:

100°/h to 555°, Soak 15 min
200°/h to 820°, Soak 2.5 hours
Full to 516°, Soak 5 hours
10°/h to 488°, Soak 1 hour
25°/h to 388°, Soak 2 hours
50°/h to 150°, Soak 1 hour OFF

Notes:

The purpose of the test was to see how symmetrical, round dots would stretch.

The elements were stacked vertically and crosswise inside the mould. The results show that the dots stretched into organic shapes, spaced in relative order. 10x7x4cm. Photos: Sheila Labatt



TEST #93

Materials:

Bullseye Tekta,
Black Opal (100)

Mould Type:

Ceraboard

Firing Type:

Kiln Casting

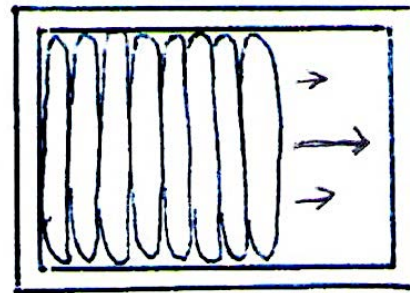

TOP VIEW
MOVEMENT

Firing Schedule:

100°/h to 555°, Soak 15 min
200°/h to 820°, Soak 2.5 hours
Full to 516°, Soak 5 hours
10°/h to 488°, Soak 1 hour
25°/h to 388°, Soak 2 hours
50°/h to 150°, Soak 1 hour OFF

Notes:

The purpose of the test was to see how organic, asymmetrical and randomly placed dots would stretch and whether the dots would still be clearly visible.

The elements were stacked vertically and crosswise inside the mould. The result evokes contemporary Chinese brush and ink calligraphy. 10x7x4cm.
Photos: Sheila Labatt

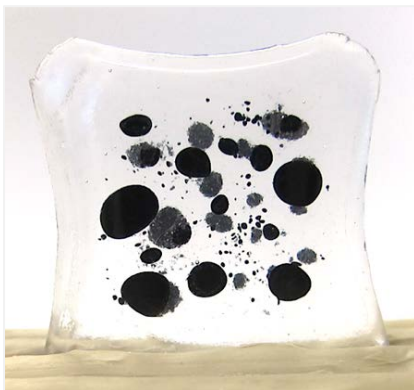

TEST #94

Materials:

Bullseye Tekta,
Black Opal (100),
Light Silver (1429)

Mould Type:

Ceraboard

Firing Type:

Kiln Casting

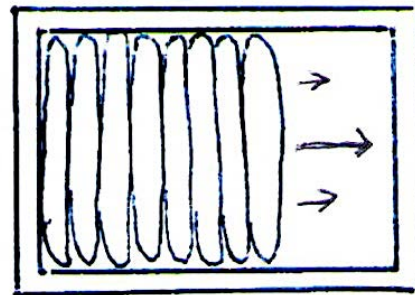

TOP VIEW
MOVEMENT

Firing Schedule:

100°/h to 555°, Soak 15 min
200°/h to 820°, Soak 2.5 hours
Full to 516°, Soak 5 hours
10°/h to 488°, Soak 1 hour
25°/h to 388°, Soak 2 hours
50°/h to 150°, Soak 1 hour OFF

Notes:

The purpose of the test was to see how fused, asymmetrical dots and silver powder would flow and stretch and whether the dots would still be clearly visible through the light silver powder.

The elements were stacked vertically and crosswise inside the mould. The result was that the silver powder inclusions partially obscured the black dot inclusions, which stretched during firing. 10x7x4cm. Photos: Sheila Labatt



TEST #95

Materials:

Bullseye Tekta,
Black Opal (100)

Mould Type:

Ceraboard

Firing Type:

Kiln casting

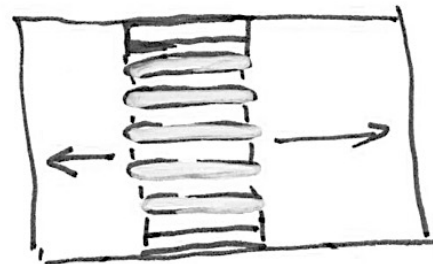

Top

Firing Schedule:

100°/h to 555°, Soak 15 min
200°/h to 820°, Soak 2.5 hours
Full to 516°, Soak 5 hours
10°/h to 488°, Soak 1 hour
25°/h to 388°, Soak 2 hours
50°/h to 150°, Soak 1 hour OFF

Notes:

The purpose of the test was to investigate two-directional flow using powder-fused elements, when placed in a specific orientation.

The elements were stacked vertically and lengthwise in the centre of the mould, to allow the glass to flow in two directions. The result evokes horizontal Chinese ink landscape. 10x7x4cm. Photos: Sheila Labatt

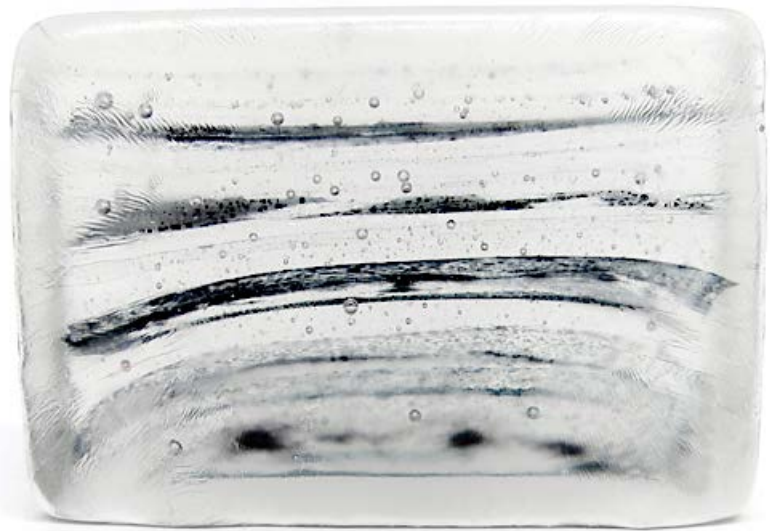

TEST #96

Materials:

Bullseye Tekta
Bullseye Black Opal (100)

Mould Type:

Ceraboard

Firing Type:

Kiln casting

Firing Schedule:

100°/h to 555°, Soak 15 min
200°/h to 820°, Soak 2.5 hours
Full to 516°, Soak 5 hours
10°/h to 488°, Soak 1 hour
25°/h to 388°, Soak 2 hours
50°/h to 150°, Soak 1 hour OFF

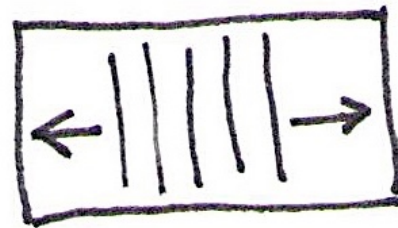

TOP

Notes:

The purpose of the test was to observe the effect of two-directional flow on the black powder inclusions.

The fused elements were stacked vertically and crosswise inside the mould so as to allow a two-directional flow. The result shows fair gradations through greyscale and somewhat evokes ink wash. 10x7x4cm. Photos: Sheila Labatt



TEST #97

Materials:

Bullseye Tekta,
Black Opal (100)

Mould Type:

Ceraboard

Firing Type:

Kiln casting

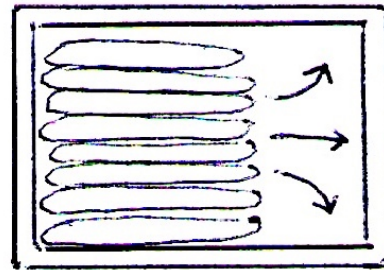

TOP VIEW
MOVEMENT

Firing Schedule:

100°/h to 555°, Soak 15 min
200°/h to 820°, Soak 2.5 hours
Full to 516°, Soak 5 hours
10°/h to 488°, Soak 1 hour
25°/h to 388°, Soak 2 hours
50°/h to 150°, Soak 1 hour OFF

Notes:

The purpose of the test was to investigate flow on a grid-like assembly of the elements when placed in a specific orientation.

The lines on the elements were turned 90° from those on each neighbouring element and placed vertically and lengthwise into a mould, for unidirectional flow. 10x7x4cm. Photos: Sheila Labatt



TEST #98

Materials:

Bullseye Tekta,
Black Opal (100)

Mould Type:

Ceraboard

Firing Type:

Kiln casting

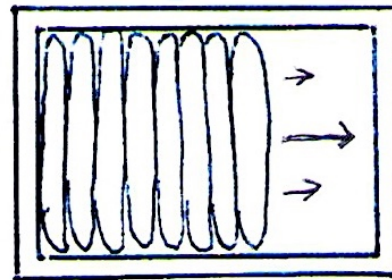

TOP VIEW
MOVEMENT

Firing Schedule:

100°/h to 555°, Soak 15 min
200°/h to 820°, Soak 2.5 hours
Full to 516°, Soak 5 hours
10°/h to 488°, Soak 1 hour
25°/h to 388°, Soak 2 hours
50°/h to 150°, Soak 1 hour OFF

Notes:

The purpose of the test was to investigate the effect of flow on grid-like assembly of the lines on the elements.

The lines on the elements were turned 90° from each neighbouring element and placed vertically and crosswise in a mould, creating unidirectional flow. 10x7x4cm. Photos: Sheila Labatt



TEST #99

Materials:

Bullseye Tekta,
Black Opal (100),
Tomato Red (124),
Spring Green Opal (126)

Mould Type:

ThinFire paper

Firing Type:

Fusing

Firing Schedule:

300°/h to 800°, Soak 30 min
Full to 516°, Soak 10 min OFF

Notes:

The purpose was to prepare elements for casting, using 1mm stringers.
60x60x6mm

The stringers did not move during firing and fused fully into the elements.
Photo: Sheila Labatt

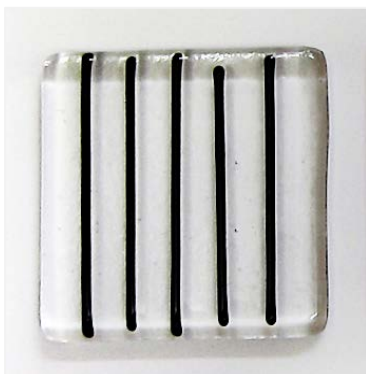

TEST #100

Materials:

Bullseye Tekta,
Black Opal (100)

Mould Type:

ThinFire paper

Firing Type:

Fusing

Firing Schedule:

300°/h to 800°, Soak 30 min
Full to 516°, Soak 10 min OFF

Notes:

The purpose of the test was to see whether vibrating black powder onto the elements would yield an apparently gestural application of ink wash.

Elements were prepared for casting, using a vibrating Oral B device for spreading the black glass powder. The results evoke a free application of markings. 60x60x6mm. Photos: Sheila Labatt



TEST #101

Materials:

Bullseye Tekta,
Black Opal (100),
Tomato Red (024)

Mould Type:

Ceraboard

Firing Type:

Kiln casting

Firing Schedule:

200°/h to 820°, Soak 1 hour
Full to 516°, Soak 12 hours
6°/h to 488°, Soak 30 min
10°/h to 388°
15°/h to 288°
20°/h to 188°
25°/h to 100° OFF

Notes:

The purpose was to drag the colour at the tips of the straight 'line' inclusions, using bubbles, to see if the lines could develop movement and tapers.

Elements were drilled through with holes (Ø15 and Ø7mm), with particular attention paid to placing holes at the ends of the inclusions' lines. The elements were stacked horizontally inside a mould. The air in the holes became bubbles during firing and rose, dragging the tips of the fused stringers to give good tapers, as in brush and ink calligraphy. 6x6x6cm. Photos: Sheila Labatt and Sylvain Deleu

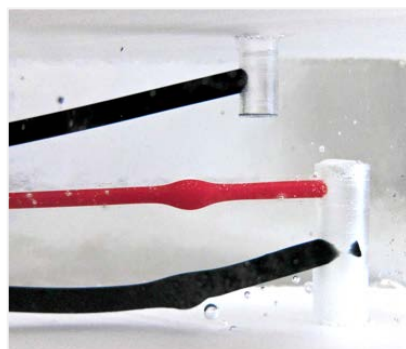
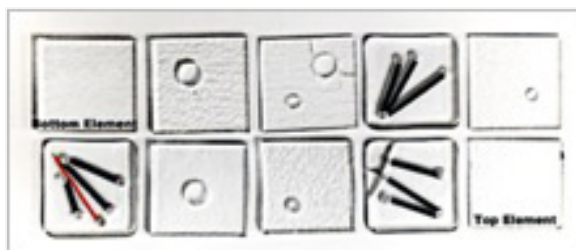

TEST #102

Materials:

Bullseye Tekta,
Black Opal (100)

Mould Type:

Ceraboard

Firing Type:

Kiln casting

Firing Schedule:

200°/h to 820°, Soak 1 hour

Full to 516°, Soak 12 hours

6°/h to 488°, Soak 30 min

10°/h to 388°

15°/h to 288°

20°/h to 188°

25°/h to 100° OFF

Notes:

The purpose was to cause bubbles to drag colour to produce 'ink wash'.

Elements, with holes (Ø15 and Ø7mm) drilled through clear pieces only. All elements stacked horizontally on bottom of square/cubic mould. Air in holes became bubbles during firing and rose, dragging fused powder. The bubbles did not fire out and only somewhat dragged the colour. 6x6x6cm. Photos: Sheila Labatt and Sylvain Deleu

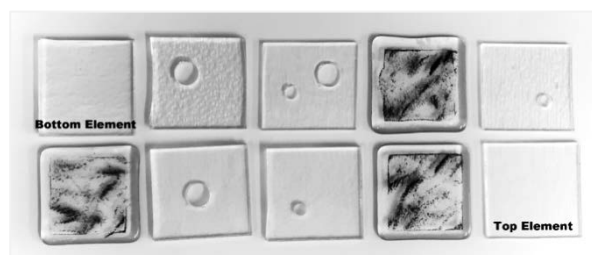

TEST #103

Materials:

Bullseye Tekta,
Black Opal (100),
Universal Medium

Mould Type:

ThinFire paper

Firing Type:

Fusing

Firing Schedule:

200°/h to 800°, Soak 30 min
Full to 516°, Soak 30 min OFF

Notes:

The purpose was to create elements, for kiln casting, that have strong, ink-like colour fields.

A thick mixture of glass powder and universal medium was spattered from a brush onto the elements being prepared for later use in kiln casting. The result shows a saturated ink-like result. 60x60x6mm. Photo: Sheila Labatt



TEST #104

(*Krakatoa*, 2013)

Materials:

Lead Crystal,
Kugler Opal Black (095),
Acrylic Impasto Medium

Mould Type:

Plaster, silica
Mild steel casing

Firing Type:

Kiln casting

Firing Schedule:

20°/h to 380, Soak 6 hours
10°/h to 830°, Soak 2 hours
Full to 650°
5°/h to 405°, Soak 60 hours
3°/h to 380°
5°/h to 300°
10°/h to 250°
25°/h to 50° OFF

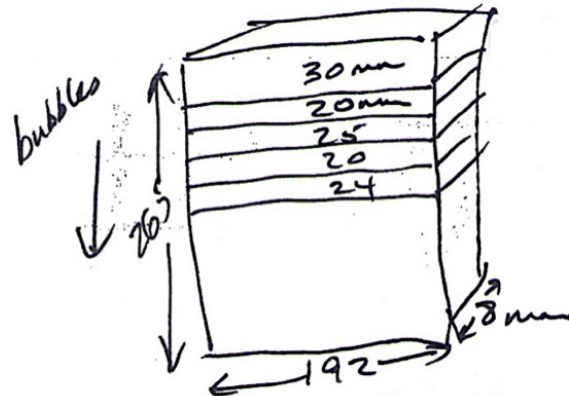

Notes:

The purpose was to create a piece with black powder inclusions, manipulated with bubbles, to produce an ink wash effect and evoke brush and ink landscape painting.

A pre-cast block was cut into 'slices'. Each slice was then carved with a grid (4mm deep) on the diamond saw and the grooves were half filled with black powder, suspended in impasto medium. The rest of each surface was also heavily coated in the powder mixture. The result shows strong, saturated and well-defined ink line and wash effects. The spaces inside the grid, left behind when the medium melted out, created bubbles of air which flowed upward, dragging the colour with it. 27x19x8cm. Photos: Sheila Labatt and Xiao Jin



TEST #105

Materials:

Glasma Furnace Glass,
Gaffer Black (G050),
Vermillion (G176),
Ivory (G102)

Mould Type:

Crystalcast

Firing Type:

Kiln Casting

Firing Schedule:

200°/h to 400°, Soak 4 hours
50°/h to 890°, Soak 1.5 hours
Full to 500°, Soak 15 hours
6°/h to 320°, Soak 6 hours
10°/h to 200°
25°/h to 100° OFF

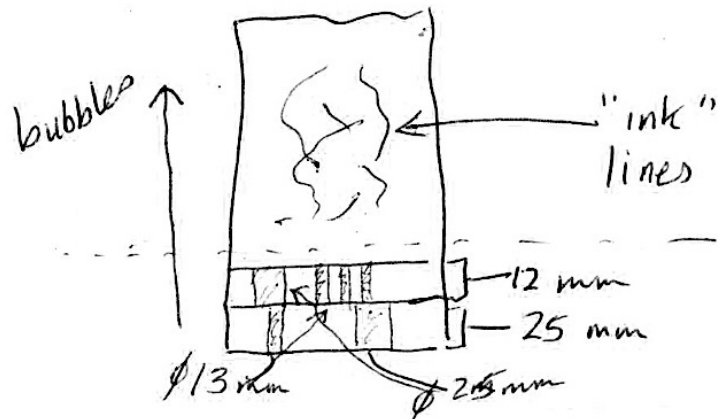

Notes:

The purpose was to assess the effect of bubble running in a block with frameworked inclusions.

A hot cast block, with black, vermilion and ivory frameworked cane inclusions, was cut and drilled with holes that would turn into bubbles during firing. The result shows saturated, gestural, ink-like marks. 18x12x10cm. Photos: Sheila Labatt and Sylvain Deleu



TEST #106

Materials:

Glasma Furnace Glass,
Gaffer Black (G050),
Vermillion (G176),
Ivory (G102)

Mould Type:

Crystalcast

Firing Type:

Kiln Casting

Firing Schedule:

200°/h to 400°, Soak 4 hours
50°/h to 890°, Soak 1.5 hours
Full to 500°, Soak 15 hours
6°/h to 320°, Soak 6 hours
10°/h to 200°
25°/h to 100° OFF

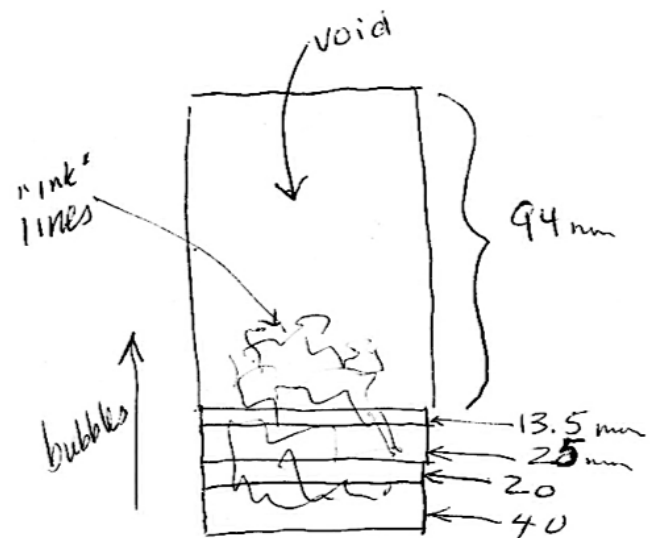

Notes:

The purpose was to investigate the effect of running bubbles through a block with existing frameworked inclusions.

A hot cast block, with black, vermillion and ivory frameworked cane inclusions, was cut and drilled to cause the holes to turn into bubbles during firing. The result shows gestural, ink-like lines with heavy veiling. 19x12x10cm. Photos: Sheila Labatt and Sylvain Deleu

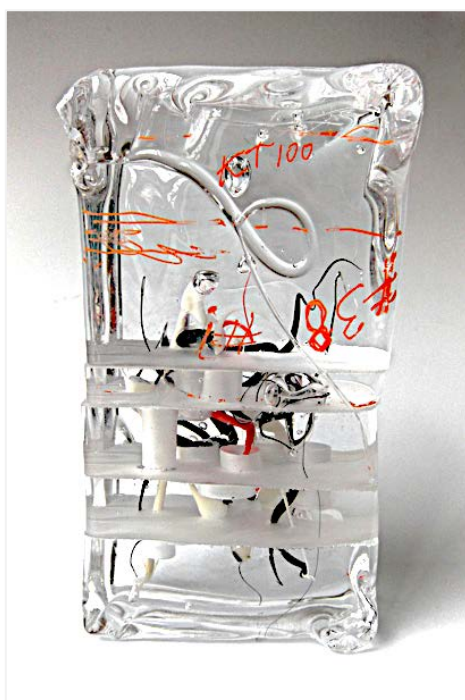

TEST #107

(*Grass Script II* [unpolished], 2015)

Materials:

Glasma Furnace Glass
Gaffer Black (G050)

Mould Type:

Plaster, silica, fibreglass

Firing Type:

Hot Casting

Firing Schedule:

From 600°
50°/h to 890°, Soak 1.5 hours
Full to 500°, Soak 15 hours
6°/h to 320°, Soak 6 hours
10°/h to 200°
25°/h to 100° OFF

Notes:

The purpose was to create Grass Script-like inclusions.

Between gathers, black, frameworked inclusions were placed into a cone-shaped mould, pre-heated in the kiln to 600°, and were manipulated with long tweezers. Once hot cast, the kiln was brought up to a casting temperature of 890°. The cone later cropped. Strong, saturated ink-like marks evoking Grass Script were achieved. Ø15x15cm. Photos: Sheila Labatt



TEST #108

Materials:

Bullseye Tekta,
Black Opal (100),

Mould Type:

Ceraboard

Firing Type:

Kiln Casting

Firing Schedule:

50°/h to 120°, Soak 1 hour
200°/h to 820°, Soak 1 hour
Full to 516°, Soak 12 hours
10°/h to 488°, Soak 6 hours
10°/h to 388°
20°/h to 188°
25°/h to 50° OFF

Notes:

The purpose of the test was to see whether a slow but steady gradation in the saturation of black 'wash' could be achieved by running bubbles through the work.

Elements, with pre-fused black powder, of differing intensities, were stacked horizontally inside the mould, with the darkest on the bottom going through to lightest at the top. Holes were drilled through the elements to create bubbles that would rise and drag the colour through the piece. The result shows ink wash-like marks in gradations through the grey scale. 13x6x6cm. Photos: Sheila Labatt



TEST #109

Materials:

Glasma Furnace Glass,
Gaffer Black (G050)

Mould Type:

Kiln bricks and fibre paper

Firing Type:

Kiln casting

Firing Schedule:

70°/h to 500°, Soak 1 hour
Full to 860°, Soak 4 hours
Full to 500°, Soak 16 hours
6°/h to 320°, Soak 4 hours
10°/h to 200°
25°/h to 50° OFF

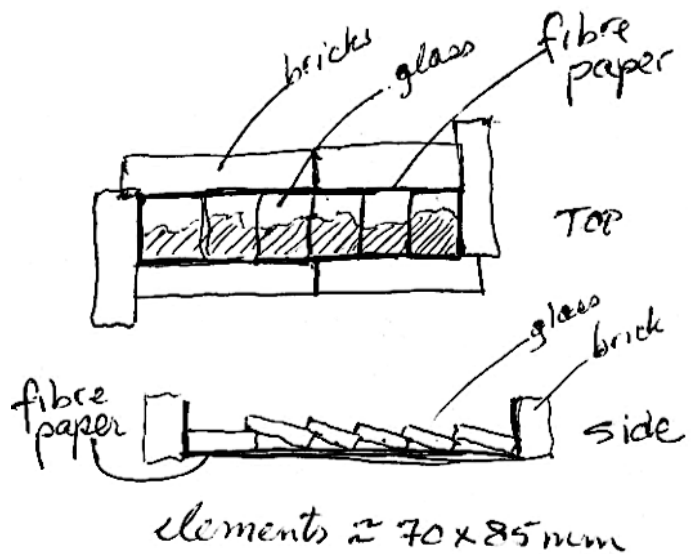

Notes:

The purpose was to create ink wash effect.

A hot cast block with black glass powder inclusions was cut into 6 slices and re-fired in a long, narrow mould. When setting up the mould for firing, the 'slices' were arranged so that they would overlap slightly, to ensure a continuity of lines and 'ink' washes from one 'slice' to the next. The black glass powder, where thinly applied, turned blue due to the oxides in its composition. The result evokes ink wash and lines in landscape, in one typical long format of traditional Chinese landscape painting. 33x10x2cm. Photos: Sheila Labatt and Sylvain Deleu



TEST #110

Materials:

Glasma Furnace Glass,
Gaffer Black (G050),
Vermillion (G176),
White (G101)

Mould Type:

ThinFire paper

Firing Type:

Fusing

Firing Schedule:

100°/h to 820°, Soak 30 min
Full to 500°, Soak 1 hour
25°/h to 50° OFF

Notes:

The purpose was to create elements for kiln casting.

Clear, hot cast billets and cane (pulled in the hot shop) were fused together to create 'custom' billets. 10.5x1.05x1.5cm. Photos: Sheila Labatt



TEST #111

Materials:

Glasma Furnace Glass,
Gaffer Black (G010)

Mould Type:

Crystalcast

Firing Type:

Kiln casting

Firing Schedule:

100°/h to 850°, Soak 5 hours
Full to 500°, Soak 24 hours
6°/h to 320°, Soak 6 hours
10°/h to 100° OFF

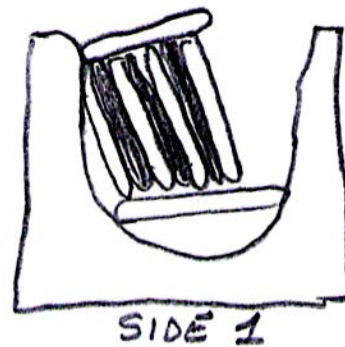

Notes:

The purpose was to create calligraphic lines using the kiln casting process.

Casting Glasma billets with fused cane (fan shape design) inclusions were placed in a hemispherical mould. The elements were stacked vertically, and each rotated 90° from its neighbour, so that there was a large void in the bottom of the mould into which the glass could flow. The results yielded gestural brush and ink-like lines and significant veiling. Ø15x8cm. Photos: Sheila Labatt



TEST #112

Materials:

Glasma Furnace Glass,
Gaffer Black (G050),
White (G101),
Vermillion (G176)

Mould Type:

Plaster, silica, fibreglass

Firing Type:

Kiln casting

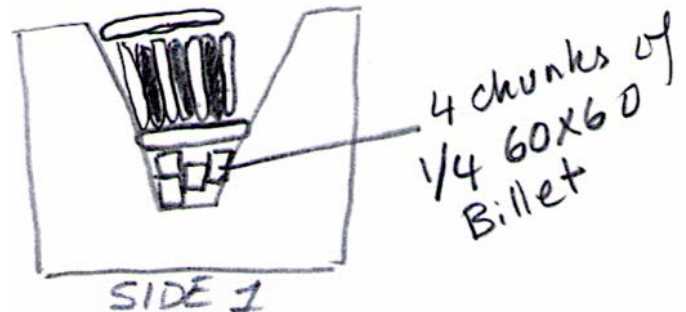

Firing Schedule:

100°/h to 850°, Soak 5 hours
Full to 500°, Soak 24 hours
6°/h to 320°, Soak 6 hours
10°/h to 100° OFF

Notes:

The purpose was to create calligraphic lines using the kiln casting process.

Casting Glasma billets with fused cane (fan shape design) inclusions were placed in a conical mould. The elements (each rotated 90° from its neighbour) and clear chunks were placed so that there would be space in the bottom of the mould into which the glass could flow. The results show gestural brush and ink-like lines. Ø15x15cm. Photos: Sylvain Deleu



TEST #113

Materials:

Glasma Furnace Glass,
Gaffer Black (G050)

Mould Type:

ThinFire paper

Firing Type:

Fusing

Firing Schedule:

100°/h to 555°

200°/h to 820°

Full to 500°, Soak 2 hours

50°/h to 320° OFF

Notes:

The purpose was to prepare billets for kiln casting by allowing blocks, previously created in the hot shop, to slump into flatter, softer-edged elements.

Clear, hot cast billets and hot cast billets with black powder inclusions were allowed to slump onto ThinFire paper. Prior to slumping, the blocks measured 6x6x2cm. Post slumping, the casting billets were 10.5x10.5x1.5cm. Photo: Sheila Labatt

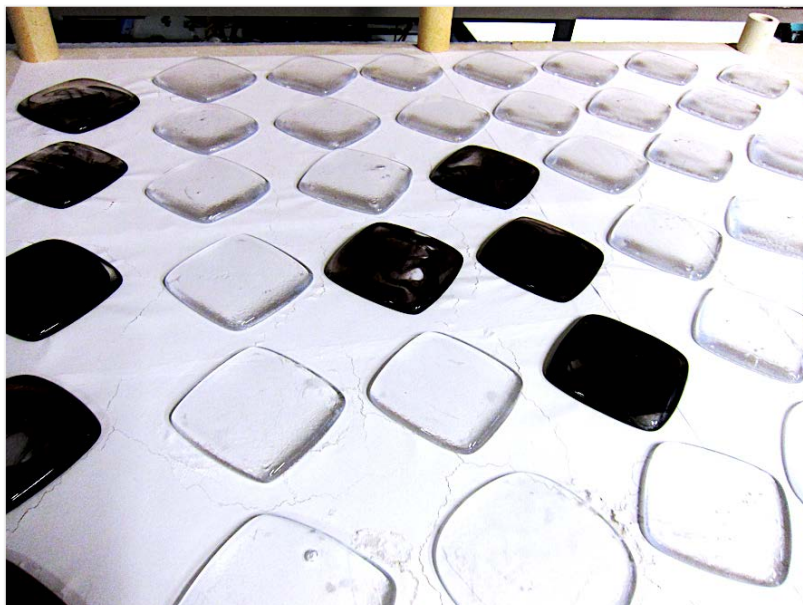

TEST #114

Materials:

Glasma Furnace Glass,
Gaffer Black (G050),
Opal White (G101)

Mould Type:

Ceraboard

Firing Type:

Kiln casting

Firing Schedule:

200°/h to 890°, Soak 2 hours
Full to 500°, Soak 15 hours
6°/h to 320, Soak 4 hours
10°/h to 200°
25°/h to 50° OFF

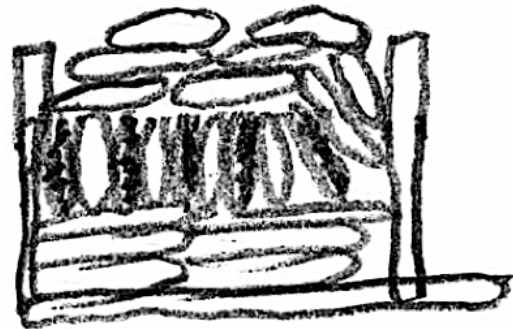

Notes:

The purpose was to embed inclusions into a kiln cast piece to evoke calligraphic lines.

Casting billets with fused cane inclusions (fan shaped design) were arranged in a cuboid mould. The billets were stacked vertically and crosswise. The block was later cropped along the lines shown, drawn in black marker. The result shows well-saturated lines. They do not, however, evoke the curving, gestural characteristics of Grass Script calligraphy. 20x13x10cm. Photos: Sheila Labatt

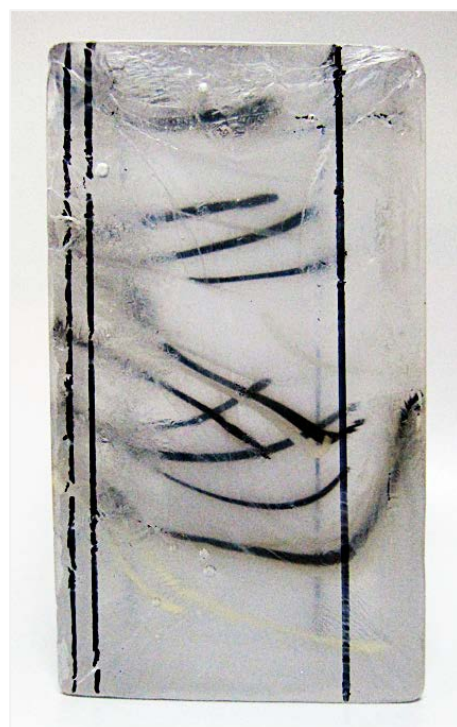

TEST #115

Materials:

Glasma Furnace Glass,
Gaffer Black (G050)

Mould Type:

Crystalcast

Firing Type:

Kiln casting

Firing Schedule:

100°/h to 890°, Soak 4 hours
Full to 500°, Soak 24 hours
6°/h to 320°, Soak 10 hours
10°/h to 50° OFF

Notes:

The purpose was to create an ink wash effect.

Casting billets with fused black powder inclusions were placed in a hemispherical mould. The billets were stacked horizontally, leaving a void in the bottom of the mould into which the glass would flow. The result shows only slight ink wash effect due to the arrangement of the coloured billets, stacked vertically, prior to casting. Ø15x8cm. Photos: Sylvain Deleu

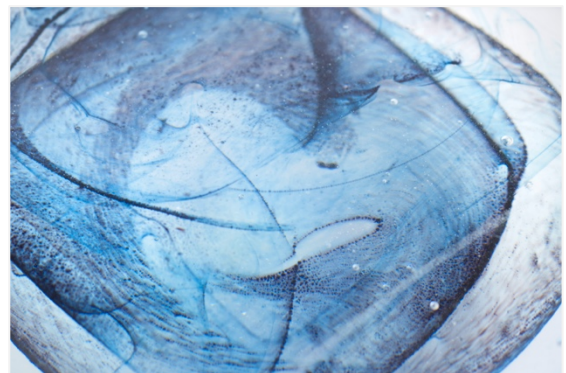
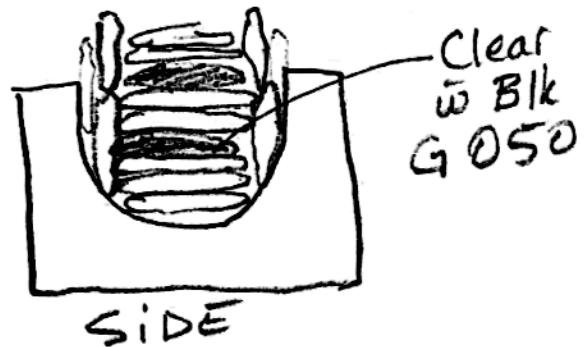

TEST #116

(Wash IV, 2016)

Materials:

Glasma Furnace Glass,
Gaffer Black (G050)

Mould Type:

Crystalcast

Firing Type:

Kiln casting

Firing Schedule:

100°/h to 890°, Soak 4 hours

Full to 500°, Soak 24 hours

6°/h to 320°, Soak 10 hours

10°/h to 50° OFF



Notes:

The purpose was to create an ink wash effect.

Casting billets with fused black powder inclusions were placed in a conical mould. The billets were stacked vertically, leaving a void in the bottom of the mould into which the glass would flow. The black powder inclusions turned blue, where thinly applied, due to the oxides used in creating Gaffer black. The result shows good 'ink wash' effect. Ø15x20cm. Photos: Sylvain Deleu



TEST #117

(Ink Pot II, 2015)

Materials:

Glasma Furnace Glass
Gaffer Black (G050)

Mould Type:

Crystalcast

Firing Type:

Hot casting

Firing Schedule:

Hot glass introduced at 550°
100°/h to 890°, Soak 4 hours
Full to 500°, Soak 24 hours
6°/h to 320°, Soak 10 hours
10°/h to 50° OFF

Notes:

The purpose was to create a piece evocative of contemporary brush and ink calligraphy.

Hot glass was poured into a pre-heated conical mould already sitting inside a kiln, adding heavy amounts of black powder between each gather, following two initial clear gathers. The temperature was then raised to kiln casting temperature to allow any bubbles to escape, though some remained on the surface, post firing. The result is 'inky' and successfully evokes contemporary Chinese calligraphy. Ø15x15cm. Photos: Sylvain Deleu



APPENDIX VI PLATES

The following images represent creative work that developed from this research. The pieces were displayed at the Royal College of Art Graduation Exhibition in June, 2017.



Plate 1 *Xiao Shan Shui* (小山水), 2014, Sheila Labatt, 11x8x2cm.
Photo: Sylvain Deleu



Plate 2 *Wash IV*, 2016, Sheila Labatt, Ø15x20cm
Photo: Sylvain Deleu



Plate 3 *Grass Script II*, 2015, Sheila Labatt, Ø15x15cm
Photo: Sylvain Deleu



Plate 4 Untitled, 2014, Sheila Labatt, 20x13x10cm
Photo: Sylvain Deleu



Plate 5 *Ink Pot*, 2015, Sheila Labatt, Ø15x15cm
Photo: Sylvain Deleu



Plate 6 *Fan II*, 2014, Sheila Labatt, 30x19x5cm
Photo: Sylvain Deleu



Plate 7 Untitled, 2015, Sheila Labatt, Ø15x15cm
Photo: Sylvain Deleu



Plate 8 *Fan*, 2014, Sheila Labatt, 30x19x5cm
Photo: Sylvain Deleu



Plate 9 *Parallax*, 2013, Sheila Labatt, Ø15x7.5cm
Photo: Ester Segarra



Plate 10 *Out of the Box II*, 2015, Sheila Labatt, 15x10x10cm
Photo: Sylvain Deleu



Plate 11 *Bonzai*, 2013, Sheila Labatt, 10x6.5x6.7cm
Photo: Sylvain Deleu

APPENDIX VII GLOSSARY

This glossary explains terms as they relate to this project and is not intended to provide exhaustive definitions.

Annealing: The process of slowly and uniformly cooling hot glass, allowing internal strain to dissipate, to prevent the glass from cracking.

Batch: Raw materials that are melted to make glass, usually for blowing.

Billets: Relatively large pieces of glass, used in kiln casting.

Blowpipe: A long steel tube used for gathering and blowing molten glass.

Bullseye: An American brand of kiln-forming glass that has been tested for compatibility across its colour range.

Burner: A torch used for flameworking, also known as lampworking.

Butterfly Effect: A concept in Chaos Theory suggesting that the batting of a butterfly's wings in one part of the world is an initial condition that sets off a chain of weather reactions globally.

Cameo Cut Glass: A technique in which glass is blown in multiple, differently-coloured layers and then carved to reveal specific colours, depending on the depth of the cuts.

Cane: A stick of glass made by stretching molten glass.

Ceraboard – A refractory board that acts as a support and separator during casting. It can be cut and used flat on the kiln shelf or as a material to create small moulds.

Chop (seal): A vermilion imprint on Chinese paintings, used to identify the artist or as a sign of appreciation of the work.

Closed Mould – A mould with a cavity that is entirely enclosed by the mould material, with a passageway leading from the outside the mould into to the cavity. Molten glass is poured, either hot cast or from a reservoir atop the mould, into this passageway (the gating system) to fill the mould.

Coefficient of (Thermal) Expansion (COE): A number that represents the rate at which glass expands and contracts. Only glasses with the same or very similar COEs are compatible and safe to fuse together.

Coldworking: Cutting, drilling, sandblasting, grinding and polishing glass, following all hot processes, to finish a piece.

Cord/Cording: An area of glass that differs slightly in composition from the surrounding material, creating a different refractive index that looks like a faint 'cord'.

Cottling Boards: Boards erected around the area into which a mould will be poured, to contain the liquid until it has set.

Crystalcast: A commercially-available, pre-mixed refractory investment powder that, when mixed with water, produces strong moulds.

dé 德: Part of the ancient Chinese Taoist philosophy of wúwéi (无为). The quality of 'virtue' exhibited by a person who is so absorbed in their work that it seems effortless.

Devitrification: A dull, 'unglassy' surface or internal crystallization. It is caused by poor annealing, over-heating and other firing errors.

Eggshells: Thinly-blown glass, used broken in this project and fused to Bullseye elements.

Firing Out – A process in which a bubble does not remain trapped inside molten glass but travels to the top of the piece and ruptures upon exiting.

Firepolishing: A process in which glass has been polished through the application of heat, which melts the surface of the glass and causes it to become smooth and 'glassy'.

Flameworking: A technique, also known as lampworking, in which glass rods and tubes are softened and manipulated in the flame of a torch.

Flashing: Thin extrusions of glass caused by minor fissures in a mould, that can form during the casting process. The cracks are large enough to allow molten glass to enter but are not severe enough to cause the mould to break.

Flatbed: A precision-engineered, flat, horizontal, rotating steel wheel head. It is used to grind glass, using either silicon carbide abrasive grit (SiC, also known as carborundum) or diamond-encrusted interchangeable discs. It is always used with slow stream of flowing water to keep the glass from overheating and cracking, due to friction.

Float Glass: Also known as window glass, a sheet of flat, highly polished industrial- molten metal, such as tin.

Flower Pots: Ordinary clay pots suspended above a mould and loaded with billets. As the glass melts, it flows through the hole in the bottom of the pot and into the mould.

Frit: Crushed, irregularly-shaped glass pieces, in sizes that range from powder to around 6mm.

Fusing: A process that occurs when pieces of abutting glass are heated enough for their surfaces to liquefy and bond with each other but are not hot enough to flow.

Gaffer Glass: A New Zealand brand of coloured glass that is compatible with Glasma furnace glass.

Gathering: A process of collecting molten glass from a furnace using a long, steel punty or blowpipe.

Glasma: A Swedish brand of blowing and hot sculpting glass, used in the Royal College of Art hot shop.

Glassblowing: The process of blowing into molten glass, through a long steel pipe, to create a hollow object which is shaped using specialised tools.

Hot Casting: A process in which molten glass is gathered from furnace and poured directly into an open mould.

Hot Sculpting: Using glassblowing tools to shape (sculpt) molten glass on a punty.

Hot Shop: A glassblowing workshop.

Jacks: A large, metal, tweezer-shaped tool used, in glassblowing or hot sculpting, to form glass.

Kiln casting: Melting room temperature glass, allowing it to assume the shape of a mould.

Kugler Colours®: A UK brand of glass colour that is compatible with Glasma furnace glass.

Lehr: A kiln used for annealing glass.

Literati: Bureaucrat-scholars in Imperial China, who developed an expressive style of landscape painting, using black ink only, beginning in the Northern Song Dynasty period (960–1279). They were also accomplished calligraphers and poets.

Marver: A flat, steel surface, used for smoothing hot glass on a blowpipe or punty, from which coloured powder can be picked up.

mò fēn wǔ sè (墨分五色) – The ‘five colours of black’ is an aesthetic in highly-accomplished Chinese landscape painting, in which different qualities of ‘black’ are used within the same work.

Mould Blowing: A bubble of molten glass is lowered into a mould and then further inflated to fill and take on the shape of the mould.

Murrini (murrine): Multi-coloured glass imagery made by fusing colours into an image, stretching it into cane and slicing the cane to reveal many identical (though smaller) images throughout the entire length of the cane.

Open Mould: A mould in which the top surface is open to the atmosphere and creates cast forms that have at least one flat surface.

Optic Mould: A conical, multi-use mould into which a glass bubble is lowered, then inflated to take on the shape of the mould.

Overlay: One coating of glass over another, differently-coloured one, as is used in Cameo cutting.

Paddle: A flat, water-laden, wooden board used for shaping hot glass.

Pâte de Verre: A kiln-forming technique in which glass frit is mixed with a binder and applied to the inner surface of a mould. The frit is then fused, in a kiln.

Picking up: Rolling a hot gather over coloured glass powder on the marver.

pīnyīn: The official romanisation system for Mandarin Chinese.

Press-moulding: A form of casting, in which hot glass is sandwiched between two half-moulds, that was used in ancient Chinese glassmaking.

Punty – A long, steel rod used for gathering glass out of a furnace for hot sculpting.

qì 气: The life force or energy flow that permeates Chinese culture, particularly Chinese medicine, and should be demonstrated in landscape painting.

Refractory Mould: A mould made of plaster and heat-resistant materials that can withstand glass casting temperatures.

Seed Bubbles: Tiny bubbles trapped inside glass.

Shibusa 渋さ: A Japanese aesthetic philosophy that describes ultimate beauty in art in terms of exuberance and restraint and distinguishes between spontaneity of action and spontaneity of effect.

Slumping: A process of heating glass to working temperature, when it becomes soft and gradually bends with gravity to take on the form of a mould.

Soaking: Holding the kiln at a given temperature to allow the entire volume of glass time to arrive at the same temperature.

Specific Volume: The number of cubic meters occupied by one kilogram of a given glass.

Spontaneity of Action: Part of the Japanese philosophy of shibusa 渋さ, in which spontaneity comes directly from the artist's unconscious. It is considered 'genuine' spontaneity.

Spontaneity of Effect: Part of the Japanese philosophy of shibusa 渋さ, in which spontaneity is brought on by an external event, such as ash in a kiln or a blow to a clay pot before it has dried rather than an artist's unconscious.

Stringer: Thread of glass. Bullseye stringers of 0.5 to 2 mm in diameter were used in this project.

Tekta: Sheet of Bullseye glass, available in thicknesses of 3, 4 and 6mm.

Thermal Shock: A quick shift in temperature, causing glass to break, crack or shatter.

ThinFire paper: Bullseye brand lightweight, ceramic-impregnated paper used to prevent warm glass from adhering to the kiln shelf.

Veiling - A milky field inside cast glass, often at the intersection of billets or cut elements used in the casting process.

Working Temperature: A range of temperatures at which warm or hot glass is soft enough to move and be shaped.

wúwéi (无为) – The ancient Taoist ethical philosophy of 'doing' by 'not doing' or 'action without action'. It is used when speaking of spontaneity, in Chinese, and refers to a state in which an artist is so absorbed in their work that it seems effortless. A person in wúwéi exhibits the moral quality of dé 德 (virtue).

yīn and yáng 阴阳: A Chinese philosophy of the natural world in which opposites are interdependent, complementary and in balance with each other.

(the) Zone: Also known as Flow, a state similar to wúwéi and described by Mihály Csikszentmihályi, in which a person experiences intense focus and is so immersed in their work that it seems effortless.

BIBLIOGRAPHY

- Abbott, Edwin A., *Flatland: A Romance of Many Dimensions by A Square*, Dover Thrift Editions (New York: Dover Publications, 1992)
- Addison, Joseph, 'Pleasures of Imagination', *Papers from The Spectator*, 1712 <<http://philosophy.lander.edu/intro/articles/addisonart-a.pdf>> [accessed 5 October 2017]
- Alexander Tutsek-Stiftung, 'Glass.China', *Alexander Tutsek-Stiftung*, 2008 <<http://www.atutsek-stiftung.de/exposition-article/glass-china/?!lang=en>> [accessed 11 March 2017]
- Alkandari, Fahad, 'Islamic Ceramic Ornamentation and Process: Proposals for a New Aesthetic Vocabulary in Contemporary Architectural Embellishment within Kuwait' (PhD Thesis, University of Central Lancashire, 2011)
- Allen, Joseph R., 'I Will Speak, Therefore, of a Graph: A Chinese Metalanguage', *Language in Society*, Cambridge University Press, 21 (1992), pp. 189–206 <<http://www.jstor.org/stable/4168342>> [accessed 2 November 2017]
- Anderson, Harriette, *Kiln-Fired Glass*, 2nd ed. (McLean, VA: H. Anderson, 1997)
- Aristotle, *Physics Books I and II*, trans. by William Charlton, Clarendon Aristotle Series (Oxford University Press, 1979)
- Art-Asia, 'Chinese Ink and Inkstone', *Art-Asia.Net: For Asian Art Appreciation*, nd <http://www.asia-art.net/chinese_ink_s.html> [accessed 31 October 2016]
- Asia-Art.net, 'Chinese Art, Chinese Brush Painting', *How to Look at Chinese Paintings*, nd <<http://www.asia-art.net/how-to-look-at-chinese-paintings/>> [accessed 24 December 2016]
- , 'How to Look at Chinese Paintings', nd <http://www.asia-art.net/how-to-look-at-chinese-paintings/> [accessed 25 September 2017]
- Ball, Philip, *Flow: Nature's Patterns – A Tapestry in Three Parts* (Oxford: Oxford University Press, 2009)
- Bao Fanren, *Calligraphy Dictionary for 5 Calligraphy Styles* (Chinese Edition) (Shanghai: Shanghai Bookstore Publishing House, 2011)

- Barcio, Phillip, 'The Revolution Abstract Acrylic Painting Brought to the Medium', *Ideel Art: Online Galleries for Contemporary Abstract Art*, nd
<<http://www.ideelart.com/module/csblog/post/292-1-abstract-acrylic-painting.html>> [accessed 31 March 2018]
- Barnhart, Richard, 'Chinese Calligraphy: The Inner World of the Brush', *The Metropolitan Museum of Art Bulletin*, published by: *The Metropolitan Museum of Art*, New Series, 30 (1972), pp. 230–241
<<http://www.jstor.org/stable/3258680>> [accessed 16 February 2015]
- Barnhart, Richard, and Nie Chongzheng, *Three Thousand Years of Chinese Painting* (New Haven: Yale University Press, 1997)
- Barrass, Gordon S., *The Art of Calligraphy in Modern China*, (London: The British Museum Press, 2002), RCA Library
- Beevers, David, *Chinese Whispers: Chinoiserie in Britain, 1650–1930* (Brighton: Royal Pavilion and Museums, 2009)
- Belgrad, Daniel, *The Culture of Spontaneity: Improvisation and the Arts in Postwar America* (Chicago: University of Chicago Press, 1998)
- Benefield, Scott, 'A Short History of the Studio Glass Movement', *Articles*, 2012
<http://www.scottbenefield.com/Scott_Benefield/Articles/Entries/2012/10/18_A_Short_History_of_the_Studio_Glass_MovementOriginally_published_in_Past_and_Present%2C_Peter_Layton_and_London_Glassblowing%2C_2012.html> [accessed 2 May 2017]
- Berggruen, Olivier, *The Writing of Art* (London: Pushkin Press, 2011)
- Beveridge, Philippa, Ignasi Domenech, and Eva Pascual, *Warm Glass: A Complete Guide to Kiln-Forming Techniques: Fusing, Slumping, Casting*, trans. by Eric A. Bye (New York: Lark Books, A Division of Sterling Publishing Co. Inc., 2005)
- Beyond Calligraphy, 'Flying White: 飛白, Kasuri', *Beyond Calligraphy*, Online
<http://www.beyondcalligraphy.com/flying_white_script.html> [accessed 24 October 2016]
- Blair, Deirdre, *Saul Steinberg: A Biography* (New York: Nan A. Talese/Doubleday & Co Inc., 2012)
- Blue, Chiani, 'Why Chinese Women Wear Jade Bracelets', *Vision Times*, 2015
<<http://www.visiontimes.com/2015/07/08/why-chinese-women-wear-jade-bracelets.html>> [accessed 10 March 2017]

- Boulton, James T., ed., *A Philosophical Enquiry into the Origin of Our Ideas of the Sublime and Beautiful* (London: Routledge and Kegan Paul, 1958)
- Brachlow, Heike, 'Shaping Colour: Density, Light and Form in Solid Glass Sculpture' (PhD Thesis, Royal College of Art, 2012)
- Braghin, Cecilia, ed., *Chinese Glass: Archaeological Studies on the Uses and Social Context of Glass Artefacts from the Warring States to the Northern Song Period (fifth century BC to twelfth century AD)*, *Orientalia Venetiana*, 14 (Firenze: Olschki, 2002)
- , 'Polychrome and Monochrome Glass of the Warring States and Han Periods', in *Chinese Glass. Archaeological Studies on the Uses and Social Context of Glass Artefacts from the Warring States to the Northern Song Period (fifth century BC to twelfth century AD)*, ed. by Cecilia Braghin, *Orientalia Venetiana* (Firenze: Olschki, 2002), xiv, pp. 3–43
- Bray, Charles, *Dictionary of Glass Materials and Techniques*, 2nd ed. (London: A & C Black Publishers Limited, 2001)
- Brewerton, Andrew, 'Essay', in *GlassRoutes: From Wolverhampton to China*, ed. by Stuart Garfoot (Wolverhampton, UK: University of Wolverhampton, CADRE Publications, 2008), pp. 11–19
- , *Fusion: Glass Art of Shelly Xue* (Shanghai Museum of Glass, 2013), Exhibition Catalogue
- British Glass, 'Facts about Glass', *British Glass*
<<http://www.britglass.org.uk/facts-about-glass>> [accessed 18 October 2013]
- British Library, 'Diamond Sutra', *Online Gallery, Sacred Texts*, nd
<<http://www.bl.uk/onlinegallery/sacredtexts/diamondsutra.html>> [accessed 10 September 2017]
- Britton, Alison, and Simon Olding, eds., *Three by One – A Selection from Three Public Craft Collections by Alison Britton* (UK: Crafts Council in Partnership with the Crafts Study Centre, 2009)
- Brown, Denis, 'Ink 2008: For All Writers', *Quill Skill*, 2008
<http://www.quillskill.com/frameset/frameset_movies.html> [accessed 27 August 2017]

- Bryanton, Rob, 'Imagining the Tenth Dimension: Impossible to See the Third Dimension?' 2012
 <<http://imaginingthetenthdimension.blogspot.co.uk/2012/01/poll-86-impossible-to-see-3rd-dimension.html>> [accessed 17 June 2015]
- , 'Imagining the Third Dimension' *Talking Dog Studios*, 2011
<http://www.youtube.com/watch?v=-D4swzK4sKk> [accessed 17 June 2015]
- Buckley Ebrey, Patricia, 'Guo Xi's Early Spring', *A Visual Sourcebook for Chinese Civilization*, nd
 <<https://depts.washington.edu/chinaciv/painting/4Indguox.htm>> [accessed 25 November 2016]
- Buckley Ebrey, Patricia, and University of Washington, 'Technical Aspects of Painting', *A Visual Sourcebook of Chinese Civilization*, nd
 <<https://depts.washington.edu/chinaciv/painting/4ptgtech.htm>> [accessed 8 January 2017]
- Bullseye Glass Co., 'Technotes – Volume and Bubble Control: Understanding Distortion and Trapped Air When Firing Bullseye Glass', nd
 <https://www.warm-glass.co.uk/images/pdfs/Bullseye%20TechNotes_05.pdf> [accessed 18 July 2017]
- Bunyard, Paul, 'Gretna Green Starling Murmurations', *Wild About Images*, 2013
 <<https://www.youtube.com/watch?x-yt-ts=1422503916&x-yt-cl=85027636&v=M1Q-EbX6dso>> [accessed 5 May 2013]
- Burke, Edmund, *A Philosophical Enquiry into the Origin of Our Ideas of the Sublime and Beautiful*, Oxford World's Classics (Oxford: Oxford University Press, 2008)
- Burton, David M., 'Pate de Verre and Cast Glass', *Glass Art Society Journal*, (1985), pp. 90–91
- Bush, Susan, and Shih Hsio-yen, *Early Chinese Texts on Painting*, 2. ed. (Hong Kong: Hong Kong Univ. Press, 2013)
- Börsch-Supan, H., and A Royer, *Caspar David Friedrich* (Bruckmann, 1976)
- Cahill, James, *Hills beyond a River: Chinese Painting of the Yüan Dynasty, 1279–1368*, *A History of Later Chinese Painting, 1279–1950*; v.1, 1st ed. (New York: Weatherhill, 1976)

- California State University, Fullerton, *Cast Glass Sculpture: The Main Art Gallery*, Visual Arts Center, April 12–May 11, 1986 (Fullerton: Art Gallery, California State University, Fullerton, 1986)
- Capcom, *Ōkami*, PS2 and Wii, 2006
<<https://www.youtube.com/watch?v=ZloCD06QjiE>> [accessed 2 December 2016]
- Carvalho, David N. 'Forty Centuries of Ink', *Seattle, WA: The World Wide SchoolTM*, 1999
<[http://www.worldwideschool.org/library/books/tech/printing/FortyCenturie
sofInk/legalese.html](http://www.worldwideschool.org/library/books/tech/printing/FortyCenturie%20ofInk/legalese.html)> [accessed 25 November 2013]
- Cavani, Edinson, *One Stroke Snake Painting for 2013*, 2013
<<https://www.youtube.com/watch?v=dKJkBFEWc3g>> [accessed 24 October 2016]
- CCTV, 'Loretta Yang: The Woman behind the Liuli Phenomenon' *CCTV.com*, 2007
<[http://www.cctv.com/video/cultureexpress/2007/04/cultureexpress_128_2
0070417_7.shtml](http://www.cctv.com/video/cultureexpress/2007/04/cultureexpress_128_20070417_7.shtml)> [accessed 26 March 2017]
- Chastanet, Francois, 'Dishu: Ground Calligraphy in China', *Dokument Press*
<<https://www.youtube.com/watch?v=sxkvFLsHam0>> [accessed 25 November 2016]
- Chastanet, François, 'Dishu Brush Contrast #2' Beijing, 2011
<<https://vimeo.com/album/1877116/video/49303046>> [accessed 10 January 2017]
- Chemistry World, 'Ink Chemistry: There's More to Ink than Meets the Eye, Says Joy Kunjappu', *Chemistry World, The Royal Society of Chemistry*, 2003
<<https://www.chemistryworld.com/news/ink-chemistry/3002158.article>>
[accessed 29 August 2017]
- Chen, Nancy N., 'Speaking Nearby: A Conversation with Trinh T. Minh-Ha', in L. Taylor, ed. *Visualising Theory: Selected Essays from Visual Anthology Review 1990-1994* (New York: Routledge, 2013), pp. 443–451
<<https://docfilmhist.files.wordpress.com/2008/09/chen.pdf>> [accessed 26 December 2017]

- Chen Tingyou, *Chinese Calligraphy*, trans. by Ren Lingjuan, Introduction to Chinese Culture in 30 Volumes (New York: Cambridge University Press, originally published by China Intercontinental Press as Chinese Calligraphy in 2010, 2011), British Library Archive
- Chen Xiao, 'The Untrammelled Brushwork: Huang Binhong's Late Landscape Paintings', *Hong Kong University of Science and Technology, Virginia Review of Asian Studies*, (2013), pp. 143–168
- China Online Museum, 'Along the River during the Qingming Festival', <<http://www.comuseum.com/painting/famous-chinese-paintings/along-the-river-during-the-qingming-festival/>> [accessed 27 November 2016]
- China Online Museum, 'Literati Painting', nd <<http://www.comuseum.com/painting/schools/literati-painting/>> accessed [accessed 20 January 2017]
- Chinen, N., 'He's a Jazz Virtuoso Who Can Barely See Over a Baby Grand', *International New York Times*, 13 May 2015, New York edition, p. A1
- 'Chinese Arts – Handicrafts: Ritual Bronze Vessels', *Chinese Arts – Handicrafts: Ritual Bronze Vessels*, author unknown <<http://www.chinaknowledge.de/Art/Bronze/bronze.html>> [accessed 4 January 2017]
- Chomsky, Noam, *Aspects of the Theory of Syntax*, 50th Anniversary Edition (Cambridge, MA: The MIT Press, 2014)
- Chu Siu-Hang, 'Making Digital Painting Organic' (PhD Thesis, The Hong Kong University of Science and Technology, 2007)
- Chua Boon Kee, '《饮水思源》 “Flowing” Winner of SUSTAIN Project – 3rd Landmark Sculpture for Chinatown, London', *The Sculpture Arts of Chua Boon Kee*, 2014 <http://www.chuaboonkee.com/Chua_Boon_Kee/Projects/Pages/yin_shui_si_yuan_Flowing.html> [accessed 20 November 2016]
- Clapham, Christopher, and James Nicholson, 'Line', *The Concise Oxford Dictionary of Mathematics*, 4th ed. (Oxford ; New York: Oxford University Press, 2009)
- Clarke, David, *Water and Art*, (London: Reaktion Books Ltd., 2010)
- Clunas, Craig, 'Art in China', *Oxford History of Art*, 2nd ed. (Oxford ; New York: Oxford University Press, 2009)

- Conroy, Sarah Booth, 'Artist in a Brave New Glass World', *The Washington Post*, 1980
 <https://www.washingtonpost.com/archive/lifestyle/1980/05/04/artist-in-a-brave-new-glass-world/e1250c85-e1c1-4a4f-843f-81df72ac56fe/?utm_term=.eab35ee764bb> [accessed 4 May, 2017]
- Conway, Judith, 'Kiln Forming Glass: An Intro to Glass Slumping', *Glass Craftsman*, November (2000), pp. 30–31, 34
- Corning Museum of Glass, *Meet the 2012 Rakow Commission Artist: Steffen Dam* (2012) <<http://www.cmog.org/event/meet-2012-rakow-commission-artist-steffen-dam>> [accessed 1 October 2013]
- , 'Biography: Steffen Dam', nd <<http://www.cmog.org/bio/steffen-dam>> [accessed 29 May 2017]
- , 'Casting', *Corning Museum of Glass Online Dictionary*
 <<https://www.cmog.org/glass-dictionary/casting>> [accessed 7 December 2016]
- , 'Mold Blowing', *Corning Museum of Glass Online Dictionary*
 <<http://www.cmog.org/video/mold-blowing>> [accessed 4 May 2017]
- , 'Pate de Verre', *Corning Museum of Glass Online Dictionary*
 <<http://www.cmog.org/research/glass-dictionary>> [accessed 17 January 2017]
- , 'Steffen Dam: Recipient of the 2012 Rakow Commission', *The Gather*, Fall /Winter 2013, 2012, p. 11
- , *Tom Patti: Meet the Artist* (Corning, NY, 2008)
 <<http://www.cmog.org/event/meet-artist-tom-patti>> [accessed 4 April 2017]
- , 'Pate de Verre', *Corning Museum of Glass Online Dictionary*,
 <<http://www.cmog.org/research/glass-dictionary>> [Accessed January 17, 2017]
- Csikszentmihályi, Mihaly, *Flow: The Psychology of Optimal Experience*, Harper Perennial Modern Classics (New York: Harper and Row, 2009)
- Csikszentmihályi, Mihaly, *Flow, the Secret to Happiness*, TED Talks, 2004
 <https://www.ted.com/talks/mihaly_csikszentmihalyi_on_flow> [accessed 15 January 2017]

- Cultural China, 'In Memory of Confucius in a Dream', *Arts: Calligraphy and Painting* <<http://arts.cultural-china.com/en/23Arts11429.html>> [accessed 25 February 2015]
- Cummings, Keith, *A History of Glassforming* (London: A & C Black, 2002)
———, *Contemporary Kiln-Formed Glass* (London: A & C Black, 2009)
———, *Techniques of Kiln-Formed Glass* (London ; Philadelphia: A & C Black ; University of Pennsylvania Press, 2007)
- Curtis, Emily Byrne, *Pure Brightness Shines Everywhere: The Glass of China*, ed. by Emily Byrne Curtis (Aldershot, UK ; Burlington, VT: Ashgate Publishing, 2004)
- Dallow, Peter, 'Representing Creativeness: Practice Based Approaches to Research in Creative Arts'
<<https://www.rhul.ac.uk/english/documents/pdf/pbrphd/dallowrepresentingcreativeness.pdf>> [accessed 9 March 2014]
- Dam, Steffen, *End of My Garden* (New York: Heller Gallery, NY, 2009), Exhibition Catalogue
- de Beaumont, Thierry, 'Antoine Leperlier : Clartés Cosmiques', *Revue de La Céramique et Du Verre*, April 2017 <http://www.antoine-leperlier.com/medias/fichiers/donner_sa_chance_au_hasard.pdf> [accessed 25 June 2017]
- Delamare, François, and Bernard Guineau, *2000 Colors: The Story of Dyes and Pigments* (New York: Harry N. Abrams, 2000)
- Department of Asian Art, 'Neolithic Period in China', *Heilbrunn Timeline of Art History. New York: The Metropolitan Museum of Art, 2000–, 2004* <http://www.metmuseum.org/toah/hd/cneo/hd_cneo.htm> [accessed 8 January 2017]
- , 'Northern Song Dynasty (960–1127)', *Heilbrunn Timeline of Art History. New York: The Metropolitan Museum of Art, 2000–, 2001* <http://www.metmuseum.org/toah/hd/nsong/hd_nsong.htm> [accessed 11 May 2016]
- Department of Polymer Science: The University of Southern Mississippi, 'The Glass Transition' <<http://www.pslc.ws/macrog/tg.htm>> [accessed 15 October 2013]

- Despeux, Catherine, and Livia Kohn, *Women in Daoism*, 1st ed. (Cambridge, MA: Three Pines Press, 2003)
- Dessamae, Lorrain, 'An Archaeologist's Guide to Nineteenth Century American Glass', *Historical Archaeology*, II, (1968), pp. 35–44
- Dewar, Richard, *Stoneware*, Ceramics Handbooks (London : Philadelphia: A & C Black ; University of Pennsylvania Press, 2002)
- de Zegher, Catherine, *The Stage of Drawing : Gesture and Act : Selected from the Tate Collection* (UK and USA: Tate Publishing and The Drawing Center, 2003)
- Doerner, Max, *The Materials of the Artist and Their Use in Painting, with Notes on the Techniques of the Old Masters*, trans. by E Neuhaus, Rev. ed., 1st Harvest/HBJ ed. (San Diego: Harcourt Brace Jovanovich, 1984)
- Dormer, Peter, *The Art of the Maker: Skill and Its Meaning in Art, Craft and Design* (Thames and Hudson, 1994)
- Dowse Art Museum, *Ann Robinson Casting Light: A Survey of Glass Castings, 1981–1997* (Lower Hutt, Aotearoa, N.Z.: The Dowse Museum, 1998), Exhibition Catalogue
- Dynacast, 'Tolerances', *Dynacast: Solutions Made Solid*
<<https://www.dynacast.com/tolerances>> [accessed 24 November 2016]
- Elkins, James, *Chinese Landscape Painting as Western Art History* (Hong Kong ; London: Hong Kong University Press, 2010)
- , ed., *Is Art History Global?* Art Seminar, v. 3 (New York ; London: Routledge, 2007)
- Ella, 'Why People Wear Jade Bangle [sic]', *Noble Jades*, 2015
<<http://www.noblejades.com/why-people-wear-jade-bangle.html>>
[accessed 1 January 2016]
- Elman, Benjamin A., 'Civil Service Examinations (科 舉 kējǔ)', *Berkshire Encyclopedia of China* (Great Barrington, MA: Berkshire Encyclopedia of China, 2000), pp. 405–410
<<https://www.princeton.edu/~elman/documents/Civil%20Service%20Examinations.pdf>> [accessed 10 January 2017]
- Encyclopedia of Art, Pen and Ink Drawings, 'History, Types, Effects of Drawing with Pen and Ink', nd, <<http://www.visual-arts-cork.com/drawing/pen-and-ink-drawings.htm>> [accessed 10 August 2016]

- Endō, Orië, 'Endangered System of Women's Writing from Hunan, China', *World of Nushu*, nd <<http://nushu.world.coocan.jp/home>> [accessed 3 July 2016]
- Etienne, Noemie, Manuel Charpy, and Jean Estebanez, 'Things Between Worlds: Creating Exoticism and Authenticity in the West, from the 19th Century to the Present', ed. by Noemie Etienne, *Material Culture Review*, 2015, 1
- Euclides, *Euclid's Elements of Geometry: The Greek Text of J.L. Heiberg (1883–1885): From Euclidis Elementa, Edidit et Latine Interpretatus Est I.L. Heiberg, in Aedibus B.G. Teubneri, 1883–1885*, ed., trans. by Richard Fitzpatrick, Revised and corrected (Richard Fitzpatrick, 2008)
- Evans, Kim, *Portrait of an Artist: Jackson Pollock*, 1987 <<https://www.youtube.com/watch?v=uy1SXVAIrDI>> [accessed 12 December 2016]
- Fan Jinshi, 'Master Plan for the Conservation and Management of the Mogao Grottoes: Preparation and Achievements', in *Conservation of Ancient Sites on the Silk Road*, ed. by Neville Agnew, Symposium Proceedings (Los Angeles, USA: Getty Publications, 2010)
- Fariello, M.A., and P. Owen, eds., *Objects and Meaning: New Perspectives on Art and Craft* (Lanham: Scarecrow Press Inc., 2005)
- Farrer, Anne, *The Brush Dances & The Ink Sings – Chinese Paintings and Calligraphy from The British Museum* (London: Balding and Mansell plc, 1990), RCA Library Archive
- Fasching, Darrell J., and Dell deChant, *Comparative Religious Ethics: A Narrative Approach* (Oxford ; Malden, MA: Blackwell, 2001)
- Ferlicity, 'China's Five Elements Philosophy – Wood, Fire, Earth, Metal, and Water', *China Highlights*, 2017 <<https://www.chinahighlights.com/travelguide/chinese-zodiac/china-five-elements-philosophy.htm>> [accessed 13 April 2017]
- FEVE, 'Why Choose Glass?' *The European Container Glass Federation*, nd <<http://feve.org/about-glass/>> [accessed 8 January 2017]

- Flavell, Raymond Maurice, 'The Development and Application of the Use of Encased Voids within the Body of Glass Artefacts as a Means of Drawing and Expression' (PhD Thesis, Edinburgh College of Art / Heriot-Watt University School of Design and Applied Arts, 2001)
- Fox, Judith Hoos, 'August Ventimiglia: Sculpting the Line', *Sculpture (Washington, D.C.)*, 30 (2011), pp. 46–49
- Franklin, Gerd, 'Exhibition Reviews: Americans in Glass', *Glass Art Society Journal* (1985), pp. 107–108
- Frantz, Susanne K, and Jean-Luc Olivié, *The Mythologies, Origins, and Developments of Pate de Verre in Particle Theories: International Pâte de Verre and Other Cast Glass Granulations* (Millville, NJ: Museum of American Glass at Wheaton Village, 2005), Exhibition Catalogue
- Frantz, Susanne K, Jean-Luc Olivié, and Museum of American Glass, *Particle Theories: International Pâte de Verre and Other Cast Glass Granulations* (Millville, NJ: Museum of American Glass at Wheaton Village, 2005)
- , *Pâte de Verre: The Beautiful Conundrum in Particle Theories: International Pâte de Verre and Other Cast Glass Granulations*, trans. by Paul Bombeck (Millville, N.J.: Museum of American Glass at Wheaton Village, 2005), Exhibition Catalogue
- Frantz, Suzanne K., 'Glass Tiger', in *GlassRoutes: From Wolverhampton to China*, ed. by Stuart Garfoot (Wolverhampton, UK: University of Wolverhampton, 2008)
- Frantz, Suzanne K, "'Cast Glass Sculpture' April 12–May 11, 1986", *Glass Art Society Journal*, (1986), pp. 107–110
- Fu Shen C.Y., Marilyn W. Fu, Mary G. Neill, and Mary Jane Clark, *Traces of the Brush – Studies in Chinese Calligraphy* (Yale University Art Gallery, 1977), Library of Congress Archive
- Gan Fuxi, Cheng Huan Sheng, Hu Yong Qing, Ma Bo, and Gu Dong Hong, 'Study on the Most Early Glass Eye-Beads in China Unearthed from Xu Jialing Tomb in Xichuan of Henan Province', *Science in China Press*, Science in China series E: Technological Sciences, 52 (2009), pp. 922–27 <<https://link.springer.com/content/pdf/10.1007/s11431-008-0341-0.pdf>> [accessed 20 October, 2017]

- Gaskell, Ivan, 'Spilt Ink: Aesthetic Globalization and Contemporary Chinese Art', *The British Journal of Aesthetics Published by Oxford University Press*, 52 (2012), pp. 1–16 <<https://doi.org/10.1093/aesthj/ayr052>> [accessed 27 November 2016]
- Gibbs, Phillip, 'Is Glass Liquid or Solid?' *The Physics and Relativity FAQ*, 1997 <<http://math.ucr.edu/home/baez/physics/General/Glass/glass.html>> [accessed 6 August 2017]
- Giles, Lionel, 'Chinese Calligraphy', 7 (1933), pp. 77–78 <<http://jstor.org/stable/4421447>> [accessed 3 August 2014]
- Gioia, Ted, *The Imperfect Art: Reflections on Jazz and Modern Culture*, Portable Stanford Book Series (New York: Oxford University Press, 1990)
- Glasner, William, 'Glasma 705...Specifically for the Hot Glass Studio Market...', *Studio Glass Batch LLC*, 2003 <<https://www.studioglassbatch.com/Glasma-batch.html>> [accessed 27 July 2017]
- Glass Masters Series: Loren Stump* (Salem Community College NJ, 2007) <<https://www.youtube.com/watch?v=NRTThXub6piE>> [accessed 1 June 2017]
- 'Glass Viscosity Calculation Based on a Global Statistical Modeling Approach' (author unknown) <<http://glassproperties.com/viscosity/>> [accessed 24 September 2013]
- Gleick, James, *Chaos: Making a New Science*, 20th anniversary ed. (New York, NY: Penguin Books, 2008)
- Goodson, Geoffrey R., *Chaotic Dynamics: Fractals, Tilings, and Substitutions*, Cambridge Mathematical Textbooks (Cambridge, UK ; New York, NY: Cambridge University Press, 2017)
- Guan Donghai, *Sand Cast and Kiln Glass: A Chinese Context* (Saarbrücken, De: Lap Lambert Academic Publishing, 2014)
- Guan Zhi, 'Seven Principles of Brush and Ink: The Aesthetic Principles of Brush and Ink in the Field of Traditional Chinese Brush and Ink Painting', *Majestic Ink*, 2017 <<http://www.inkgz.com/blog/seven-principles-of-brush-and-ink-the-aesthetic-principles-of-b>> [accessed 28 May 2017]

- Gulbitten, Ozgur, John C. Mauro, Olus N. Boratav, and Guo Xiaojun, 'Viscous Flow of Medieval Cathedral Glass', *Journal of the American Ceramic Society*, (2017), pp. 1–7
 <http://onlinelibrary.wiley.com/doi/10.1111/jace.15092/epdf?r3_referer=wol&tracking_action=preview_click&show_checkout=1&purchase_referrer=onlinelibrary.wiley.com&purchase_site_license=LICENSE_DENIED>
 [accessed 27 November, 2018]
- Guo Jianyong 郭建永, "Inside Painting", as Used for Chinese Snuff Bottles, Suggested as a New Model for Contemporary Glass Art' (PhD Thesis, University of Sunderland, 2016)
- Halem, Henry, *Glass Notes: A Reference for the Glass Artist* (Kent, OH: Franklin Mills Press, 2006)
- Hay, Jonathan, *Shitao: Painting and Modernity in Early Qing China*, RES Monographs in Anthropology and Aesthetics (New York: Cambridge University Press, 2001)
- Hearn, Maxwell, 'Chinese Painting', *Heilbrunn Timeline of Art History, The Metropolitan Museum of Modern Art*, 2008
 <http://www.metmuseum.org/toah/hd/chin/hd_chin.htm> [accessed 20 August 2017]
- , 'Landscape Painting in Chinese Art', *Heilbrunn Timeline of Art History. New York: The Metropolitan Museum of Art, 2000–*, 2008
 <http://www.metmuseum.org/toah/hd/chin/hd_chin.htm> [accessed 15 April 2016]
- Hearn, Maxwell K., Wu Hung, and Metropolitan Museum of Art (New York, NY), eds., *Ink Art: Past as Present in Contemporary China* (New York: The Metropolitan Museum of Art, 2013)
- Helmholtz, H, 'The Origin and Meaning of Geometrical Axioms', *Mind, Digital Edition Compiled by Gabriele Dörflinger, Heidelberg University Library*, 2007, 1 (1876), pp. 301–321 <<http://www.ub.uni-heidelberg.de/helios/fachinfo/www/math/txt/Helmholtz/geo2e.pdf>>
 [accessed 23 April 2017]
- Hensher, Philip, *The Missing Ink: How Handwriting Made Us Who We Are* (Macmillan; Main Market Ed. edition, 2013)

- He Weimin, 'The Mystery of Empty Space: Tradition in 20th Century Chinese Painting', *The Ashmolean*, 2005
 <http://www.heweimin.org/Texts/mystery_of_empty_space.pdf> [accessed 29 August 2017]
- Higashida, Naoki, *The Reason I Jump: One Boy's Voice from the Silence of Autism*, trans. by Keiko Yoshida and David Mitchell (London: Sceptre, 2013)
- Hill, John E., *Through the Jade Gate to Rome: A Study of the Silk Routes during the Later Han Dynasty 1st to 2nd Centuries CE: An Annotated Translation of the Chronicle on the 'Western Regions' in the Hou Hanshu* (Charleston, SC: BookSurge Publishing, 2009)
- Hinton, David, ed., *Classical Chinese Poetry: An Anthology*, trans. by David Hinton, Paperback (New York, NY: Farrar, Straus and Giroux, 2010)
- Hipple Jr., W.J., *The Beautiful. The Sublime & The Picturesque in Eighteenth-Century British Aesthetic Theory* (Carbondale: The Southern Illinois University Press, 1957)
- Holden, Andy, *Starlings over Gretna* (Gretna, Scotland, 2008)
 <<http://www.youtube.com/watch?v=8vhE8ScWe7w&feature=related>> [accessed 11 March 2013]
- Hollister, Paul, 'A Search for Inner Form: Steven Weinberg's Innovative Casting Technique Opens New Glass Vistas', *Collector Editions Quarterly*, 8 (1980), pp. 5–8
- , 'Cast Glass by Steven Weinberg', *The Glass Club Bulletin of The National Early American Glass Club*, (1980)
- Hourdin, Nina, 'L'art verrier contemporain en Chine' (Masters Thesis II) (Mémoire de Master II), (Université de Paris IV – Sorbonne, 2010)
- Hsüan Hua, *Secrets of the Five Elements: Age-Old Treasures from China* (Burlingame, CA: Buddhist Text translation Society, 2005)
- Hua Ling Su, 'On the Relation between Chinese Painting and Calligraphy', ed. by Istituto Italiano per il Medio ed Estremo Oriente, *East and West*, published by Istituto Italiano per l'Africa e l'Oriente (IsIAO), 4 (1954), 269–77 <http://www.jstor.org/stable/29758102> [accessed 14 May, 2015]

- InkDance Chinese Painting Gallery, 'Chinese Rice Paper / Xuan Zhi / Xuan Paper', nd
<<http://www.inkdancechinesepaintings.com/knowledge/chinese-rice-paper.html>> [accessed 5 November 2015]
- James, David, 'Hands-on with Czech Cast Glass', *Glass Gazette, Glass Art Association of Canada*, February (2000)
- Janiak, Andrew, 'Kant's Views on Space and Time', *The Stanford Encyclopedia of Philosophy*, 2016
<<https://plato.stanford.edu/archives/win2016/entries/kant-spacetime/>> [accessed 20 August 2017]
- Janson, Jonathan, 'Hand Grinding and the Purchase of Materials', *Essential Vermeer*
<http://www.essentialvermeer.com/palette/palette_grinding_and_materials.html#.WHOVsLGcYdV> [accessed 12 December 2016]
- Jiang Yonglin, *The Mandate of Heaven and the Great Ming Code.*, trans. by Jiang Yonglin, Asian Law Series (Seattle, WA: University of Washington Press, 2010)
- Jisho, 'Hitofudegaki', nd, <<http://jisho.org/word/一筆書き#>> [accessed 1 November 2017]
- Johnson, Owen, 'Glass, Pattern, and Translation: A Practical Exploration of Decorative Idiom and Material Mistranslation Using Glass Murrine' (PhD Thesis, Royal College of Art, 2015)
- Kangas, Matthew, 'Daniel Clayman: The Object Is the Image', *The UrbanGlass Art Quarterly*, 75 (1999), pp. 38–43
- Kant, Immanuel, *Critique of Judgment*, trans. by Werner S. Pluhar (Indianapolis, IN: Hackett Pub. Co, 1987)
- Kelly, Jessamy, 'The Combination of Glass and Ceramics as a Means of Artistic Expression in Studio Practice' (PhD Thesis, University of Sunderland, 2009)
- Kemp, Martin, *Christ to Coke: How Image Becomes Icon* (Oxford ; New York: Oxford University Press, 2011)
- Kendon, Adam, *Gesture: Visible Action as Utterance* (UK: Cambridge University Press, 2004)

- Khatibi, Abdelkebir, *The Splendor of Islamic Calligraphy* (New York: Thames and Hudson, 1996)
- Kim, Christopher F, *Early Chinese Lead-Barium Glass: Its Production and Use from the Warring States to Han Periods (475 BCE–220 CE)* (Providence, RI: Joukowsky Institute for Archaeology, Brown University, 2012), Professor Carolyn Swan, ARCH0305
<[https://www.brown.edu/academics/archaeology/search/brown?query=Early%20Chinese%20Lead-Barium%20Glass%3A%20%20Its%20Production%20and%20Use%20from%20the%20Warring%20States%20to%20Han%20Periods%20\(475%20BCE-220%20CE\)](https://www.brown.edu/academics/archaeology/search/brown?query=Early%20Chinese%20Lead-Barium%20Glass%3A%20%20Its%20Production%20and%20Use%20from%20the%20Warring%20States%20to%20Han%20Periods%20(475%20BCE-220%20CE))> [accessed 20 October 2017]
- Kim Ki-Ra, 'Contemporary Glass in Korea', *The Glass Art Society Journal*, (2005), pp. 68–69
- Klenell, Ragnar, 'Vallien's Dreams: An Interview', *The Urban Glass Art Quarterly*, 75 (1999), pp. 28–33
- Kohler, Lucartha, *Glass: An Artist's Medium* (Iola, WI: Krause Publications, 1998)
- , *Women Working in Glass*, a Schiffer Art Book (Atglen, PA: Schiffer Pub, 2003)
- Kopp, Ed, 'A Brief History of the Blues', *All About Jazz*, 2005
<<https://www.allaboutjazz.com/a-brief-history-of-the-blues-by-ed-kopp.php>> [accessed 22 March 2017]
- Kuiter, Wybe, *Themes, Scenes, and Taste in the History of Japanese Garden Art*, Japonica Neerlandica, 3 (Amsterdam: Gieben, 1988)
- Kuspit, Donald, 'High Glass Art', in *Cast Glass Sculpture: The Main Art Gallery*, Visual Arts Center, California State University, Fullerton, April 12–May 11, 1986 (Fullerton, CA: Art Gallery, California State University, Fullerton, 1986), pp. 11–15
- Kwo Da-Wei, *Chinese Brushwork in Calligraphy and Painting: Its History, Aesthetics, and Techniques*, Dover (New York: Dover Publications Inc.; New edition, 2003)
- Labatt, Sheila, *Video: Hot Shop Demonstration by Lorin Silverman, Using Jacks and Paddle as a Mould*, 2013, Corning Museum of Glass (unpublished)

- Lalvani, Mohan, ed., 'Scientific Facts about Glass', Kanch, *The Quarterly Journal of the All India Glass Manufacturers Federation*, 9 (2001), p. 21
- LaMonte, Karen, 'Global Glass: Czech Republic', *The Urban Glass Art Quarterly*, (1999)
- LaMonte, Karen, and Smithsonian American Art Museum, Interview: Cast Dresses, 2010
<http://americanart.si.edu/multimedia/video/lamonte/lamonte_interview.cfm?width=490&height=320> [accessed 16 January 2017]
- Lao Zi, 'The Canon of Reason and Virtue (Lao-Tze's Tao Teh King)', trans. by D.T. Suzuki and Paul Carus, *1913 Translation of Second Century Text, Chapter 5—The Function of Emptiness* <<http://www.sacred-texts.com/tao/crv/>> [accessed 29 August 2017]
- Laozi (Lao Tzu), *Lao Tzu: Tao Te Ching*, trans. by Ursula K Le Guin (Boston: Shambhala, 1998)
- , *Tao Te Ching*, trans. by Stephen Addiss and Stanley Lombardo (Boston: Shambhala, 2007)
- Laozi, and Ursula K Le Guin, *Lao Tzu, Tao te ching: A Book About the Way and the Power of the Way* (Boston, MA; London: Shambhala, 1998)
- Larmer, Brook, 'Caves of Faith', *National Geographic Magazine, Online*, June 2010 <<http://ngm.nationalgeographic.com/print/2010/06/dunhuang-caves/larmer-text>> [accessed 22 May, 2017]
- Lee, J. H., 'Asian Aesthetics Manifested in Gestural Expressionism', *The Collegiate Journal of Art, Dartmouth College*, X (2014)
<http://data.axmag.com/data/201501/20150101/U130496_F318720/media.pdf#page=22> [accessed 18 March 2015]
- Lee Taub, Vanessa, *Artist Zhuang Xiaowei: The Father of Chinese Contemporary Glass Sculpture*, 2011
<https://www.youtube.com/watch?v=Z5GM93gah_A21> [accessed 3 September, 2017]
- Lees, Nicholas B., 'Drawing and Fabrication: An Exploration of Transitions between Two and Three Dimensions' (MPhil Thesis, Royal College of Art, 2012)

- Leperlier, Antoine, *An Untimely Position* (Nancay, Fr: Galerie Capazza, 2002), Exhibition Catalogue <http://www.antoine-leperlier.com/medias/fichiers/an_untimely_position_english_text_pdf_32_ko.pdf> [accessed 12 March 2017]
- Leperlier, Antoine, and Manuel Fadat, Conversation avec Antoine Leperlier in *Corps de Verre: Musée du Verre de Carmaux*, 2011, Exhibition Catalogue <http://www.antoine-leperlier.com/medias/fichiers/entretien_avec_manuel_Fadat.pdf> [accessed October 24 2017]
- Le Verre, le Cristal et la Pâte de Verre, 'Qu'est ce que la Pâte de Verre ?', 2014 <<https://leverreetlecrystal.wordpress.com/2014/01/14/quest-ce-que-la-pate-de-verre/>> [accessed 17 January 2017]
- Lhôte, Jean-Marie, Ambivalence of Past and Present: Interview with Antoine Leperlier, 1999 <http://www.antoine-leperlier.com/medias/fichiers/ambivalence_of_past_and_present_english_text_pdf_88_ko.pdf> [accessed 25 September 2017]
- Li Dongxu, *Chinese Landscape Painting*, trans. by Wen Jingen and Pauline Cherrett (Beijing: Foreign Language Press, 2009)
- Li, Henry, *How to Make Sumi Ink from Inkstick and Inkstone*, Blue Heron Arts, 2009 <<https://www.youtube.com/watch?v=CeeCCf-F8os>> [accessed 17 November 2016]
- , *What Is the Difference between Chinese Painting Ink an Watercolour?* Blue Heron Arts, 2016 <<http://painting-art.wonderhowto.com/how-to/understanding-difference-between-ink-watercolor-294082/>> [accessed 23 November 2016]
- Lin Ci, *Chinese Painting*, Introduction to Chinese Culture in 30 Volumes (New York, NY: Cambridge University Press, originally published by China Intercontinental Press as Chinese Calligraphy (9787508516691) in 2010, 2011)
- Ling, Manny, 'Calligraphy Across Boundaries' (PhD Thesis, University of Sunderland, 2008)
- , *Manny Ling Lesson Part A*, 2011 <<https://www.youtube.com/watch?v=dyzGuRN0dQg>> [accessed 24 May 2017]

- Lippe, Aschwin, 'The Waterfall', *The Metropolitan Museum of Art Bulletin New Series*, 12 (1953), pp. 60–67
- Little, Stephen, and Shawn Eichman, *Taoism and the Arts of China* (Chicago: Art Institute of Chicago; University of California Press, 2000)
- Littman, Brett, 'Short Take: Mark Ferguson', *The Urban Glass Art Quarterly*, 75 (1999), pp. 44–45
- Liu Jin, 'Deviant Writing and Youth Identity: Representation of Dialects with Chinese Characters on the Internet', *Chinese Language and Discourse*, 2 (2011), pp. 58–79
- LLGF Corporation, 'Liuli', *Liuligongfang*, 2014 <<http://www.liuli.com/en-us/introduction.aspx>> [accessed 26 March 2017]
- Long, Jean, *Chinese Ink Painting: Techniques in Shades of Black* (Poole, Dorset: Blandford Press, 1984)
- Lorenz, E. N., 'Predictability: Does the Flap of a Butterfly's Wings in Brazil Set off a Tornado in Texas?', in *139th Meeting of the American Association for the Advancement of Science* (presented at the New Approaches to Global Weather, Massachusetts Institute of Technology, Cambridge, MA, 1972) <http://web.mit.edu/lorenzcenter/about/LorenzPubs/Butterfly_1972.pdf> [13 July 2016]
- Luebtow, John Gilbert, 'Glass Fusing and Slumping', *Glass Art Society Journal*, 1985, pp. 94–95
- Luffy, C, 'Wenda Gu Has Infused the Genre of Chinese Ink Painting with Unexpected Characters and Materials', *ARTnews*, 2000, pp. 140–43
- Lundstrom, Boyce, *Glass Casting and Moulmaking: Glass Fusing, Book Three*, ed. by Kathleen Lundstrom (Portland, OR: Vitreous, 1989)
- , *Kiln Firing Glass: Glass Fusing, Book One*, ed. by Lola M Salmonson, Phoenix ed. (Colton, OR: Vitreous Publications Inc., 1994)
- Luo Xiaosu, 'Cubism Tendency in Contemporary Glass Art' (unpublished Masters Dissertation, Shanghai University, 2008)
- Lurie, David, 'History of East Asian Writing Systems', 2004 <<http://www.columbia.edu/~dbl11/Lurie.EAwriting04x.pdf>> [accessed 1 July 2016]
- Lyons, John, *Noam Chomsky*, Penguin Modern Masters, Rev. ed. (Harmondsworth, UK; New York: Penguin Books, 1978)

- Macfarlane, Alan, and Gerry Martin, *The Glass Bathyscaphe: How Glass Changed the World*, Paperback ed. (London: Profile Books, 2003)
- MacGregor, Neil, *A History of the World in 100 Objects* (London: Penguin Books Ltd, 2010)
- Mandelbrot, Benoit B., 'Fractals and the Geometry of Nature' <http://users.math.yale.edu/~bbm3/web_pdfs/encyclopediaBritannica.pdf> [accessed 11 January 2017]
- Mao Zedong, 'Talks at the Yen'an Forum on Literature and Art', trans. by the Maoist Documentation Project, *Selected Works of Mao Tse-Tung*, 1942 <https://www.marxists.org/reference/archive/mao/selected-works/volume-3/mswv3_08.htm> [accessed 2 July, 2017]
- March, Benjamin, 'A Note on Perspective in Chinese Painting', *The China Journal*, VII (1927), pp. 69–72
- Mark, Emily, 'Oracle Bones: Ancient History Encyclopedia', *Ancient History Encyclopedia* <http://www.ancient.eu/Oracle_Bones/> [accessed 9 January 2017]
- Matsuoka, Seigo, and Robert Reed, *Transformation of Modern Typography in Japan 1925–95 (English translation)* (Tokyo: Toransuato, 1999)
- McCausland, Shane, *First Masterpiece of Chinese Painting – The Admonitions Scroll* (London: The British Museum Press, 2003)
- McFadden, David (Curator), 'Slash: Paper under the Knife', *Museum of Arts and Design Exhibition Catalogue, New York, October 7, 2009–April 4, 2010*, 2009
- Mecklenburg, Virginia M, *American Realism : The Sara Roby Foundation Collection* (Washington, DC: Smithsonian Institution Press, 1987), Exhibition Catalogue
- Mi, Fu, *Mi Fu on ink-stones*, trans. by Robert Hans van Gulik, 2 impr. (Bangkok: Orchid Press, 2006)
- Michelson, Maureen R., 'Delridge Project: An Unusual Cast', *Glass Studio*, (1981), pp. 4, 14
- Middendorp, Jan, ed., *Hand to Type: Scripts, Hand-Lettering and Calligraphy* (Berlin: Gestalten, 2012)
- Miles, Jonathan, 'Gesture, pp. 22–29', in *The Face, Landscape, Gesture and the Monochrome* (UK: Alexia Goethe Gallery, 2007)

- Miles Tanner, Harold, *From Neolithic Cultures through the Great Qing Empire (10,000 BCE–1799 CE), China: A History* (Indianapolis: Hackett Publishing Company, 2010)
- Mitchell, Joanne, 'Precision Air Entrapment through Applied Digital and Kiln Technologies: A New Technique in Glass Art' (PhD Thesis, University of Sunderland, 2015)
- Monk, E., *A Philosophical Enquiry into the Origin of Our Ideas of the Sublime and Beautiful* (London: Routledge and Kegan Paul, 1958)
- Monk, S.E., *The Sublime: A Study of Critical Theories in XVIII-Century England*, Ann Arbor Paperbacks (Michigan: The University of Michigan Press, 1962)
- Montouchet Zoritchak, Catherine, 'Stages pâte de verre', *Art du verre* <<http://www.catyzo.com/stages-verre/stage-pate-de-verre.htm>> [accessed 17 January 2017]
- Mori Building China (Shanghai) Co., Ltd., 'Shanghai World Financial Centre: A Global Magnet', 2008 <http://swfc-shanghai.com/pdf/swfc_project_brochure_en.pdf> [accessed 11 April 2017]
- Morton, W. Scott, and Charlton M. Lewis, *China: Its History and Culture*, 4th ed. (New York: McGraw-Hill, 2005)
- Mun-Desalle, Y-Jean, 'Pioneering Artists Loretta Yang and Steven Weinberg Push the Limits of Contemporary Glass Art', *Forbes Lifestyle*, 2017 <<https://www.forbes.com/sites/yjeanmundelsalle/2017/04/01/pioneering-artists-loretta-yang-and-steven-weinberg-push-the-limits-of-contemporary-glass-art/#46b9677b3538>> [accessed 1 June 2017]
- Møhl, Tobias, 'Tobias Møhl', *Taste: Contemporary Craft*, 2015 <<http://www.tastecontemporarycraft.com/tobias-mohl/>> [accessed 15 July 2017]
- National Palace Museum, Taipei, 'Chinese Painting', *China Online Museum*, 2017 <<http://www.comuseum.com/painting/>> [accessed 23 July 2017]
- Nelson-Atkins Museum of Art, 'Journey through Mountains and Rivers: Chinese Landscapes Ancient and Modern', *Exhibitions*, 2013 <<http://www.nelson-atkins.org/art/exhibitions/journey-through-mountains-rivers/>> [accessed 4 December 2016]

- Newton, Isaac, 'The Mathematical Principles of Natural Philosophy', trans. by Andrew Motte, 2015
 <<https://ebooks.adelaide.edu.au/n/newton/isaac/mathematical-principles-of-natural-philosophy/index.html>> [accessed 5 October 2017]
- Ngan, Siu-Mui, 'Tattoo Design Tip: Flying White', 2009
 <http://www.nganfineart.com/calli-tattoo/tattoo_styles_en.html> [accessed 24 January 2017]
- Nicolson, Marjorie Hope, *Mountain Gloom and Mountain Glory: The Development of the Aesthetics of the Infinite*, Weyerhaeuser Environmental Classics (Seattle: University of Washington Press, 1997)
- Obrist, Hans Ulrich, *Ai Weiwei Speaks with Hans Ulrich Obrist* (London: Penguin Books Ltd., 2011)
- Okamoto, Naomi, *The Art of Sumi-e: Beautiful Ink Painting Using Japanese Brushwork* (Search Press, 2015)
- Ong, Siew Chey, *China Condensed: 5000 Years of History & Culture* (Singapore: Marshall Cavendish International (Asia) Pte Ltd, 2011)
- Opie, Jennifer Hawkins, *Contemporary International Glass* (London: V & A Publications, 2004)
- Ouyang Zhongshi, and Fong Wen C., eds., *Chinese Calligraphy (Culture & Civilization of China)*, trans. by Uta Lauer, Craig Shaw, Ouyang Zhongshi, and Fong Wen C. (New Haven ; Beijing: Yale University Press, 2008)
- Oxford Living Dictionaries*, 'Spontaneous', (Oxford University Press, 2017)
 <http://www.oxforddictionaries.com/definition/english/spontaneous#spontaneous__3> [accessed 31 March 2017]
- Palata, Oldřich, *Stanislav Libenský and his school* (Prague: POPI S.R.O., 2001), Exhibition Catalogue
- Palau del Vidre, 'La Pate de Verre', *Les Différentes Techniques Autour Du Verre*, nd <<http://www.palau-verrier.com/techniques.htm>> [accessed 3 January 2018]
- Pavlouskova, Nela, *Cy Twombly: Late Paintings 2003–2011* (New York: Thames & Hudson, 2015)

- Peng Yi 彭怡, 'Cross Cultural Lampworking for Glass Art: The Integration, Development and Demonstration of Chinese and Western Lampworking Approaches, Materials and Techniques for Creative Use' (PhD Thesis, University of Sunderland, 2014)
- Perreault, John, 'Portfolio: Cast Glass, Hot and Warm', *The UrbanGlass Art Quarterly*, 75 (1999), pp. 34–37
- Petherbridge, Deanna, *The Primacy of Drawing: Histories and Theories of Practice*, 2nd ed. (USA: Yale University Press, 2011)
- Petrie, Kevin, *The New Ceramics: Ceramic Transfer Printing* (London: A & C Black Publishers Limited, 2011)
- Petrová, Sylva, *Czech Glass* (Praha: Gallery, Prague, 2001)
- Piguet, Philippe, 'Chan Ky-Yut, une vision émerveillée', *L'Oeil*, 2004, 30
<<http://search.ebscohost.com/login.aspx?direct=true&db=aft&AN=505059157&site=ehost-live>> [accessed 24 June 2016]
- Pilkington Group Limited, and Nippon Sheet Glass Co., 'Step-by-Step Manufacturing of Float Glass', 2016
<<https://www.pilkington.com/pilkington-information/about+pilkington/education/float+process/step+by+step.htm>> [accessed 29 March 2015]
- Platt, Karl P., and R.A. Morales, 'In Search of the Ideal Refractory Investment for Glass Casting', *Glass Art*, December (1989)
- Plumb, Robert C., 'Antique Windowpanes and the Flow of Supercooled Liquids', *Journal of Chemical Education*, 66 (1989), pp. 994–96
- Ponte, R, 'Seal Script', 2013 <<http://www.ink-treasures.com/history/calligraphy/chinese-calligraphy/calligraphy-scripts/seal-script/>> [accessed 21 February 2015]
- Poon, Vincent, 'Huai Su's Autobiography: Modelling (Shu Version), History, English Translation and A Preliminary Study', *Vincent's Calligraphy*, 2017
<<http://www.vincentpoon.com/autobiography-of-huai-su.html>> [accessed 10 August 2017]
- Primal Trek, 'Chinese Coins', *Primal Trek, Chinese Coins*, unknown
<<http://primaltrek.com/chinesecoins.html>> [accessed 1 January 2016]

- Proclus, *A Commentary on the First Book of Euclid's Elements*, trans. by Glenn R. Morrow, Princeton Paperbacks (Princeton, NJ: Princeton University Press, 1970)
- Qu Jin 屈金, 'Developing Pâte de Verre Glass Art through the Chinese Philosophy of Wu Wei' (PhD Thesis, University of Sunderland, 2017)
- Qu, Lei Lei, *Chinese Calligraphy – Standard Script*, 4th ed. (London: The British Museum Press, 2004), British Library
- R & R Glass-Cast, 'Products, R & R Glass-Cast Mould Material', nd
<<http://www.glass-cast.com/products.html>> [accessed 27 July, 2017]
- Rao, Venkatesh, 'The Third Dimension Is Not Simple', *Ribbonfarm: Experiments in Refracted Perception*, 2007
<<http://www.ribbonfarm.com/2007/07/11/the-third-dimension-is-not-simple/>> [accessed 13 June 2015]
- Rawson, Jessica, *Chinese Jade: From the Neolithic to the Qing* (London: The British Museum Press, 1995)
- , *The British Museum Book of Chinese Art*, ed. by Jessica Rawson, 2nd ed. (London: British Museum Press, 2007)
- Reekie, David, 'David Reekie', *Heart of England Glass*, nd
<<http://heartofenglandglass.co.uk/group-members/david-reekie/>> [accessed 3 May 2017]
- Reinhardt, Ad, 'Cycles Through the Chinese Landscape', in *Art-as-Art: The Selected Writings of Ad Reinhardt*, ed. by Barbara Rose (Berkeley: University of California Press, 1991), pp. 212–15
- Richards, John Henry, tran., *Ashtavakra Gita*, 2nd ed. (Abhaya Books, 2015)
<<http://realization.org/p/ashtavakra-gita/richards.ashtavakra-gita/richards.ashtavakra-gita.html>> [accessed 11 January 2016]
- Robinson, Ann, *Pacific Bowl*, 1991
<http://www.annrobinson.co.nz/flash/pac_6.html> [accessed 14 September 2013]
- Rosenberg, Karen, 'Move Over, Humble Doily: Paper Does a Star Turn', *The New York Times, Art and Design Section* (20 October 2009), p. C3
- Ross, Leslie, *Language in the Visual Arts: The Interplay of Text and Imagery* (Jefferson, NC: McFarland & Company, Inc., Publishers, 2014)

- Rowley, George, *Principles of Chinese Painting (Monographs in Art and Archaeology)*, July 1, 1992 (Princeton University Press, 1970)
- Ruyak, Jacqueline, 'Mia Pearlman: Capturing Ephemera', *Surface Design Journal*, 34 (2009), pp. 42–47
- Ryūruī, Ponte, 'Wizards of Ink: 王羲之 (Wáng Xīzhī, 303–361), Part I', *Beyond Calligraphy*, 2011 <https://beyond-calligraphy.com/2011/12/01/woi-wang_xizhi-p1/> [accessed 1 July 2017]
- Sacramento Chinese Culture Foundation, 'Chinese Painting and Brush Art', nd, <http://www.sccfsac.org/painting_brush_art.html> [accessed 11 May 2013]
- Sarmiento, Jeffrey R, 'Graphic Glass: Development of Creative Approaches to Expressions of Ethnicity' (PhD Thesis, University of Sunderland, 2011)
- Savard, Tracy, 'Prints and Drawings', *Introduction to the Collection Series*, 2012 <http://blog.cmog.org/2012/05/22/introduction-to-the-collection-series-prints-drawings/?utm_source=rss&utm_medium=rss&utm_campaign=introduction-to-the-collection-series-prints-drawings> [accessed 14 September 2013]
- Schmid, Ed, 'Science & Glass', *Museum of Glass*, nd <<https://museumofglass.org/document.doc?id=1327>> [accessed 4 July, 2017]
- Seung Sahn, *The Compass of Zen*, ed. by Hyon Gak, Shambhala Dragon Editions (Boston: Shambhala Publications, 1997)
- Shaffer, Mary, 'Slumping and Fusing', *Glass Art Society Journal*, (1985), pp. 96–98
- Shangri-La Hotels, 'Island Shangri-La Press Kit' (Shangri-La Hotels)
- Sharvin, John, 'Artist Statement', nd <<http://yeahsharvin.wix.com/sharvinglass#!statement>> [accessed 26 September 2017]
- Shaw Eagle, Joanna, *Aspects of Eastern and Western Calligraphy* (University of Hawaii, 1963)
- Shi Dian 时典, 'An Investigation into Contemporary Chinese Glass Calligraphy through the Application of Metal Oxides in Studio Glass' (unpublished PhD Proposal, University of Sunderland, 2017)

- Shiga, David, 'Glass Melts near Absolute Zero'
 <<http://www.newscientist.com/blogs/shortsharpsscience/2011/02/glass-melts-near-absolute-zero.html>> [accessed 15 October 2013]
- Shun, Kai Tse, *Chinese Calligraphy – Basic Brush Strokes (Eng)*, 2010
 <<https://www.youtube.com/watch?v=YSgoKEy-3QQ>> [accessed 15 September 2015]
- Silbergeld, Jerome, 'Book from the Sky: A Work by Xu Bing', *Princeton University Art Museum*, 2003
 <<https://etcweb.princeton.edu/asianart/assets/archivedmaterials/Xu%20Bing%20handout.pdf>> [accessed 30 August 2016]
- Slingerland, Edward G., *Trying Not to Try: The Art and Science of Spontaneity* (New York: Broadway Books, 2014)
- Smart, Alastair, 'Van Gogh to Kandinsky: Symbolist Landscape in Europe 1880–1910, at the Scottish National Gallery', *The Telegraph*, 15 August 2012, section Seven Magazine Edition Review
 <<http://www.telegraph.co.uk/culture/art/art-reviews/9478277/Van-Gogh-to-Kandinsky-Symbolist-Landscape-in-Europe-1880-1910-at-Scottish-National-Gallery-Seven-magazine-review.html>> [accessed 21 November 2016]
- Smithsonian American Art Museum, *Karen LaMonte: Artist Talk* (Smithsonian American Art Museum, Washington DC, 2010)
 <http://americanart.si.edu/multimedia/video/lamonte/lamonte_talk.cfm?width=730&height=530> [accessed 14 December, 2016]
- Solomon, Deborah, 'Drawing the Line, and Crossing It: "Saul Steinberg: A Biography, by Deirdre Blair"', *The New York Times*, 12 November 2012, Sunday Book Review, Online Edition
 <<http://www.nytimes.com/2012/11/25/books/review/saul-steinberg-a-biography-by-deirdre-bair.html>> [accessed 12 December 2016]
- Song, Min Jeong, 'Mechanisms of In-Betweenness: Through Visual Experience of Glass' (PhD Thesis, Royal College of Art, 2014)
- Sparke, Penny, 'Casting from Nature', *Crafts Magazine*, April 1986, pp. 39–41
- Spee, Clarissa von, *Modern Chinese Ink Paintings – A Century of New Directions* (London: The British Museum Press, 2012), British Library

- Spencer, Laura, 'A Journey through Chinese Landscapes', *KCUR 89.3 Radio*, 14 February 2013 <<http://kcur.org/post/journey-through-chinese-landscapes#stream/0>> [accessed 25 November 2016]
- Steinberg, Saul, *Drawings for the Children's Labyrinth, 10th Triennial of Milan, 1954* (Zurich: Nieves; Box edition, 2014)
- , *The Line (Detail)*, 1954
<<http://www.nieves.ch/catalogue/steinberginside.html>> [accessed 5 April 2013]
- , *Untitled*, 1948, Beinecke Rare Book and Manuscript Library, Yale University <<http://www.saulsteinbergfoundation.org/contact.html>> [accessed 5 April 2013]
- Steinhart, Peter, *The Undressed Art: Why We Draw*, 1st Vintage Books ed. (New York: Vintage Books, 2005)
- Stewart, Max D., 'The Sense of My Screaming Skin: An Investigation into the Colouring Process of Amalric Walter (1870–1959) Using Metallic Salts in Pâtes-de-Verre.' (PhD Thesis, Edinburgh College of Art, 2010)
- Strandbygaard Bitner, Pia, 'Preparing the World for Viewing'
<www.steffendam.dk/index.php?page=preparing-the-world-for-viewing> [accessed 1 October 2013]
- Strategy, Johnny, 'Psychogeographies: 3D Collages Encased in Layers of Glass by Dustin Yellin', 2014
<<http://www.thisiscolossal.com/2014/03/psychogeographies-3d-collages-encased-in-layers-of-glass-by-dustin-yellin/>> [accessed 9 January 2017]
- Swoyer, David, 'Glass Casting', *Arts Quarterly, New Orleans Museum of Art, III* (1981), p. 13
- Sze Mai-mai, *The Mustard Seed Garden Manual of Painting: Jie Zi Yuan Hua Zhuan, 1679–1701: A Facsimile of the 1887–1888 Shanghai Edition*, ed., trans. by Mai-mai Sze, Bollingen Series (Princeton, NJ: Princeton University Press, 1977)
- Tait, Hugh, ed., *5000 Years of Glass* (London, UK: British Museum Press, 2012)
- Tang Hoichiu, and Daphne King, 'Philosophical Quests and Artistic Propagation: Lui Shou-kwan as Father of New Ink Movement', in *A Legacy of Ink: Lui Shou-Kwan: 40 Years on* (Hong Kong: Alisan Fine Arts, 2015)

- Tani, Ayako, 'Ghost', *Ayako Tani Glass Art*, 2010
 <<http://www.ayakotani.co.uk/works/ghost.html>> [accessed 3 March 2017]
- , 'Multi-Dimensional Line-Drawing with Glass through a Development of Lampworking' (PhD Thesis, University of Sunderland, 2014)
- Tanizaki, Junichiro, *In Praise of Shadows*, trans. by Thomas J. Harper and Edward G. Seidensticker (Sedgwick: Leete's Island Books, 1977)
- Tanner, Harold Miles, *From Neolithic Cultures through the Great Qing Empire (10,000 BCE–1799 CE)*, China: A History (Indianapolis: Hackett Publishing Company, 2010), 1
- Tate, 'Ad Reinhardt: 1913–1967', *Art and Artists*
 <<http://www.tate.org.uk/art/artists/ad-reinhardt-1826>> [accessed 2 October 2017]
- Tate Gallery, Avis Newman, M. Catherine de Zegher, and N.Y. Drawing Center (New York, *The Stage of Drawing—Gesture and Act: Selected from the Tate Collection* (London; New York: Tate Pub. ; Drawing Center, 2003)
- Te Wei, *Feeling from Mountain and Water* (Shanghai: Shanghai Animation Film Studio, 1988) <https://www.youtube.com/watch?v=mE5F78_PUTM> [accessed 2 December 2016]
- The British Museum, 'The Portland Vase', *The British Museum Online Collection*
 <http://www.britishmuseum.org/research/collection_online/collection_object_details.aspx?objectId=466190&partId=1> [accessed 20 June 2017]
- The Metropolitan Museum of Art, 'Chinese Landscape Tattoo No. 2', Huang Yan, 1999,
 <<http://metmuseum.org/exhibitions/view?exhibitionId=%7Bca41dc2b-6bfc-45b1-890b-9c7286f66628%7D&oid=77588>> [accessed 11 December 2016]
- The Museum of Modern Art, 'Focus: Ad Reinhardt and Mark Rothko (Gallery Label)', *MoMA, The Museum of Modern Art*, 2008
 <<https://www.moma.org/collection/works/78976>> [accessed 10 March 2017]
- Thomas, Valérie, and Helen Bieri, *Verreries d'Emile Gallé: de l'oeuvre unique à la série* (Paris; Gingins: Somogy ; Fondation Neumann, 2004)

- Thwaites, Angela, *Mixing with the Best: Investigation and Comparison of Contemporary Working Methods and Mould Making Materials for Use in the Kiln Forming of Glass* (London: Arts and Humanities Research Board, Royal College of Art, 2002, CD)
- , *Mould Making for Glass: Glass Handbook* (London: A & C Black, 2011)
- Toledo Museum of Art, *Early Ancient Glass: Core-Formed, Rod-Formed, and Cast Vessels and Objects from the Late Bronze Age to the Early Roman Empire, 1600 BC to AD 50* (New York: Hudson Hills Press, 1989)
- Trapp, Kenneth R., and Howard Risatti, 'Skilled Work: American Craft in the Renwick Gallery', *National Museum of Art, Smithsonian Institution Press*, 1998 <<http://americanart.si.edu/collections/search/artist/?id=3706>> [accessed 3 May, 2017]
- Trentinella, Rosemarie, 'Roman Cameo Glass', *Heilbrunn Timeline of Art History, The Metropolitan Museum of Modern Art*, 2003 <http://www.metmuseum.org/toah/hd/rcam/hd_rcam.htm> [accessed 10 May, 2017]
- Tucker, William, *The Language of Sculpture* (London: Thames and Hudson, 1974)
- Turner, Jane, ed., 'Action Painting', *The Dictionary of Art* (New York: Grove, 1996) VI
- Twyman, Michael, *The British Library Guide to Printing: History and Techniques*, British Library Guides (Toronto: University of Toronto Press, Scholarly Publishing Division, 1999)
- Tziopanos, Niko, '*Ink*' (*Directors' Cut*) (Vimeo, 2009) <<http://vimeo.com/20409478>> [accessed 15 September 2015]
- Tzou Shwu-Huoy, 'Cultural-Specific and International Influences on and Critical Perceptions of Five Asian Installation Artists: Gu Wenda, Yanagi Yukinori, Xu Bing, Miyajima Tatsuo, and Choi Jeong-Hwa' (PhD Thesis, Texas Tech University, 2000)
- University of California, Berkley, 'Institute of East Asian Studies' Lecture Series <<http://ieas.berkeley.edu/publications/aparvlectures.html>> [accessed 12 March 2015]

- University of Washington, 'Technical Aspects of Painting', *A Visual Sourcebook for Chinese Civilisation*, nd
 <<https://depts.washington.edu/chinaciv/painting/4ptgtech.htm>> [accessed 20 July 2017]
- Valéry, Paul, *Degas, Manet, Morisot*, ed. by Jackson Mathews, trans. by David Paul, Bollingen Series, XLV, 12 (Princeton, NJ: Princeton University Press, 1989)
- Victoria and Albert Museum, *How a Silk Painting Was Made*, Masterpieces of Chinese Painting pp. 700-1900, 2013
 <<http://www.vam.ac.uk/content/exhibitions/masterpieces-of-chinese-painting/video-how-a-silk-painting-was-made/>> [accessed 17 November 2016]
- Victoria and Albert Museum, *Calligraphy in Islamic Art*, written as part of the Teachers' Resource: 'Exploring Calligraphy through the Jameel Gallery of Islamic Art', <<http://www.vam.ac.uk/content/articles/c/calligraphy-in-islamic-art/>> [accessed 25 July 2016]
- Waggoner, Shawn, 'Larger Things to Come: The Cast Glass of John Lewis', *Glass Art*, 10 (1994), pp. 54–60
- , 'Nature as a Mirror of the Human Spirit: The Work of Steffen Dam', *Glass Art*, April 2010 <www.steffendam.dk/index.php?page=glass-art-article> [accessed 1 October 2013]
- Walker, Brad, *Contemporary Warm Glass: A Guide to Fusing, Slumping, and Kiln-Forming Techniques*, 3rd ed. (Clemmons, NC: Four Corners International, 2004)
- Wang, Helen, ed., *The Music of Ink at the British Museum* (London: Saffron Books, EAP, 2012)
- Wang, Hongyuan, *The Origins of Chinese Characters* (Beijing: Sinolingua, 2004)
- Wang, Sunny 王鈴蓁, 'Contemporary Glass in China, Hong Kong, Singapore and Taiwan', *Glass Art Society Journal*, 2005, pp. 66–67
- , 'The Art of Be/Coming Through Glass: The Exploration of Studio Glass Art Inspired by Chinese Calligraphy and Framed by Buddhist Practice' (PhD Thesis, University of South Australia, 2012)
- Wang, Xianchun, *Chinese Running Script Calligraphy*, trans. by Jingen Wen and Pauline Cherrett, How To (Beijing: Foreign Language Press, 2007)

- Wang Xin, 'What Beautiful Dreams Are Made Of', *Asian Art, The Metropolitan Museum of Art*, 2014 <<http://metmuseum.org/blogs/now-at-the-met/2014/beautiful-dreams>> [accessed 30 August, 2016]
- Wangfang Data, 'Image-Based Synthesis of Chinese Landscape Painting', 2013 <http://d.g.wanfangdata.com.cn/Periodical_jsjkxjsxb-e200301003.aspx> [accessed 1 February 2013]
- Watkins-Baker, Helga, *Kiln Forming Glass* (Ramsbury: The Crowood Press, 2010)
- WeareFLINK, CCTV 'Ink' Making-of, 2010 <vimeo.com/20410575> [accessed 14 September 2015]
- , and Niko Tziopoulos, 'Ink' (Directors Cut), 2009, <<http://vimeo.com/20409478>> [accessed 15 September 2015]
- Weinberg, Steven, 'Glass Casting Techniques', *Glass Art Society Journal*, 1985, 99–103
- , 'Mandalas 2005–Present', *Weinberg Glass*, nd <<http://www.weinbergglass.com/Art/Gallery/2005-2010>> [accessed 5 July 2016]
- , 'Steven Weinberg', *Holsten Galleries: Contemporary Glass Sculpture*, nd <<http://www.holstengalleries.com/steven-weinberg/>> [accessed 11 March, 2017]
- Wenren, Jun, ed., *Ancient Chinese Encyclopedia of Technology: Translation and Annotation of the Kaogong Ji (the Artificers Record)*, Routledge Studies in the Early History of Asia, 7 (New York, NY: Routledge, 2013)
- White, Edmund, 'Cy Twombly: Late Paintings 2003–2011, by Nela Pavlouskova', *Sunday Book Review, The New York Times*, 2015 <https://www.nytimes.com/2015/06/28/books/review/cy-twombly-late-paintings-2003-2011-by-nela-pavlouskova.html?mcubz=0&_r=0> [accessed 30 September 2016]
- Whitfield, Roderick, Susan Whitfield, and Neville Agnew, *Cave Temples of Mogao at Dunhuang: Art and History on the Silk Road*, Conservation and Cultural Heritage, 9th volume, Second ed. (Los Angeles, CA: Getty Publications, 2015)

- Whitman Coleman, Sally, 'Make the Time: Contemporary Chinese Art at the Metropolitan Museum of Art', *Chinese Art, Metropolitan Museum of Art*, 2014 <<http://www.the-art-minute.com/make-the-time-contemporary-chinese-art-at-the-metropolitan-museum-of-art/>> [accessed 30 August 2016]
- Wichert, Geoff, 'Boat Forms 1999–2003', *Weinberg Glass*, nd <<http://www.weinbergglass.com/Art/Gallery/2000-2005>> [accessed 3 May 2017]
- Wilton, A, and T. Barringer, *American Sublime: Landscape Painting in the United States 1820–1880* (London: Tate Publishing, 2002)
- Wing, Mike, *Chinese Calligraphy Demonstration: Master Guoliang Huang*, 2010 <<https://www.youtube.com/watch?v=INQ6dh4yda8>> [accessed 11 March 2017]
- Winter, Dylan, *Amazing Starlings Murmuration*, Keep Turning Left, 2010 <<https://www.youtube.com/watch?v=eakKfY5aHmY>> [accessed 1 October 2014]
- Wolfe, Jonathan, 'What Is Chaos Theory?' *Fractal Foundation*, nd <<http://fractalfoundation.org/resources/what-is-chaos-theory/>> [accessed 11 January 2017]
- Wong Wucius, *The Tao of Chinese Landscape Painting: Principles and Methods* (New York: Design Press, 1991)
- Xue (Shelly) Lü, *Chinese University Glass Program: A Seed Growing with The Soil of China* (Potteries Museum, Stoke-on-Trent: New China Symposium: Ahead of the Curve, 17 April 2015), unpublished
- , 'The Investigation into the Development of Glass as an Expressive Medium in China through Direct Contact with Western Methods of Making, Decoration and Forming' (PhD Thesis, University of Wolverhampton, 2009)
- Xue (Shelly) Lü, and Wang Qin, *Lu Hua Ying Che: Qing Dai / Dang Dai Bo Li Qi Wu Zhan Zuo Pin Ji* (Shanghai: Shanghai da xue chu ban she, 2014)
- Xue (Shelly) Lü, Wang Qin, and Xue (Shelly) Lü, eds., *Now/Then: Influences of Qing Dynasty Glass on Contemporary Glass Art* (Shanghai: Shanghai University Press, 2014), Exhibition Catalogue

- Yang Boda, 'A New Milestone along the Chinese 'Glass Road', in *Liuligongfang: Loretta Hui-Shan Yang Chinese Glass Art Creative Studio* (Beijing: Palace Museum, 1991)
- Yang Lijie, L, and Xu Tianchen, 'Animating Chinese Ink Painting through Generating Reproducible Brush Strokes', *Science China Information Sciences, Springer-Verlag*, 56 (2013), pp. 1–13
<<https://doi.org/10.1007/s11432-012-4740-2>> [accessed 23 October 2014]
- Yang Xiaojian, *Black Sight*, trans. by S Chen (Shanghai: Shanghai Jielong Art Publishing Co. Ltd., 2010)
- , *My Empire of the Sun: Yang Xiaojian – The Oriental Ink Beast*, trans. by Zhang Bing Xing, Dong Xiao Ning, and Christine Wang (Hong Kong: Chinahero Publishing, 2006)
- Yang Yongliang, 'Before the Rain', *Yang Yongliang*, 2010
<<http://www.yangyongliang.com/video/64.htm>> [accessed 10 August 2017]
- , *Phantom Landscape* (Yang Yongliang, 2010)
<<http://www.yangyongliang.com/video/63.html?a=1>> [accessed 10 August 2017]
- , *The Day of Perpetual Night* (Yang Yongliang, 2012)
<<http://www.yangyongliang.com/video/60.html>> [accessed 10 August 2017]
- Yee, Chiang, *Chinese Calligraphy; An Introduction to Its Aesthetic and Technique* (London: Methuen & Co. Ltd., 1938)
- Yeh, Jeng-sheng, Ting-yu Lien, and Ouhyoung Ming, *On the Effects of Haptic Display in Brush and Ink Simulation for Chinese Painting and Calligraphy* (Taiwan: Department of Computer Science and Information Engineering, National Taiwan University, 2002), p. 3
- , 'On the Effects of Haptic Display in Brush and Ink Simulation for Chinese Painting and Calligraphy', *Proceedings of the 10th Pacific Conference on Computer Graphics and Applications (PG'02)*
- Yellin, Dustin, *A Journey through the Mind of an Artist*, TED Talks NYC, 2014
<https://www.ted.com/talks/dustin_yellin_a_journey_through_the_mind_of_an_artist> [accessed 25 November 2015]
- Young, David E, and Michiko Young, *Spontaneity in Japanese Art and Culture* (BC, Canada: Coastal Tides Press, 2012)

- Yu Yibo, 'Guo Xi', *China Online Museum*, nd
 <<http://www.comuseum.com/painting/masters/guo-xi/>> [accessed 25 November 2016]
- Yule, Henry, and A. C. Burnell, 'Hobson-Jobson: A Glossary of Colloquial Anglo-Indian Words and Phrases, and of Kindred Terms, Etymological, Historical, Geographical and Discursive, Article "Chop"', ed. by William Crooke (Online Edition, 1903)
 <https://archive.org/stream/hobsonjobsonagl02croogoog/hobsonjobsonagl02croogoog_djvu.txt> [accessed 25 November 2016]
- Zahradnik, J, 'Libensky/Brychtova Casting Techniques' (unpublished, 1986)
- Zhang Huan, 'Family Tree', 2000
 <http://www.zhanghuan.com/worken/info_71.aspx?itemid=962&parent&cid=193> [accessed 11 December 2016]
- Zhang Lin, 'Glass Art: A Shining Symbol of Chinese and Western Cultural Exchange', in *Now/Then: Influences of Qing Dynasty Glass on Contemporary Glass Art* (Shanghai: Shanghai University Press, 2014)
- Zhang Rong, 'Foreword', in *Now/Then: Influences of Qing Dynasty Glass on Contemporary Glass Art* (Shanghai: Shanghai University Press, 2014), p. 19
- Zheng, Zhonghua, *Guide to Chinese Brush Painting*, trans. by Coral Yee (Harrow Middlesex, UK: CYPI Press, 2011)
- Zong, Jianye, *Chinese Regular Script*, trans. by Jingen Wen and Pauline Cherrett (Beijing: Foreign Language Press, 2007)
- 永 (Yong) 'Forever' or 'Eternity' in Chinese Calligraphy 書法 [Regular Script], Top Chinese Arts, 2012 <<http://topartchina.com/top-chinese-calligraphy/永-yong-forever-or-eternity-in-chinese-calligraphy-書法>> [accessed 15 September 2015]
- 永 (Yong) 'Forever' or 'Eternity' in Cursive [Grass Script] Calligraphy, Top Chinese Arts, 2008 <www.youtube.com/watch?v=mZobMS08LY0> [accessed 15 September 2015]